

Dictionnaire raisonné de physique / Par M.J. Brisson.

Contributors

Brisson, Mathurin-Jacques, 1723-1806.

Publication/Creation

Paris : A la Libraire économique, 1800.

Persistent URL

<https://wellcomecollection.org/works/xuy37df4>

License and attribution

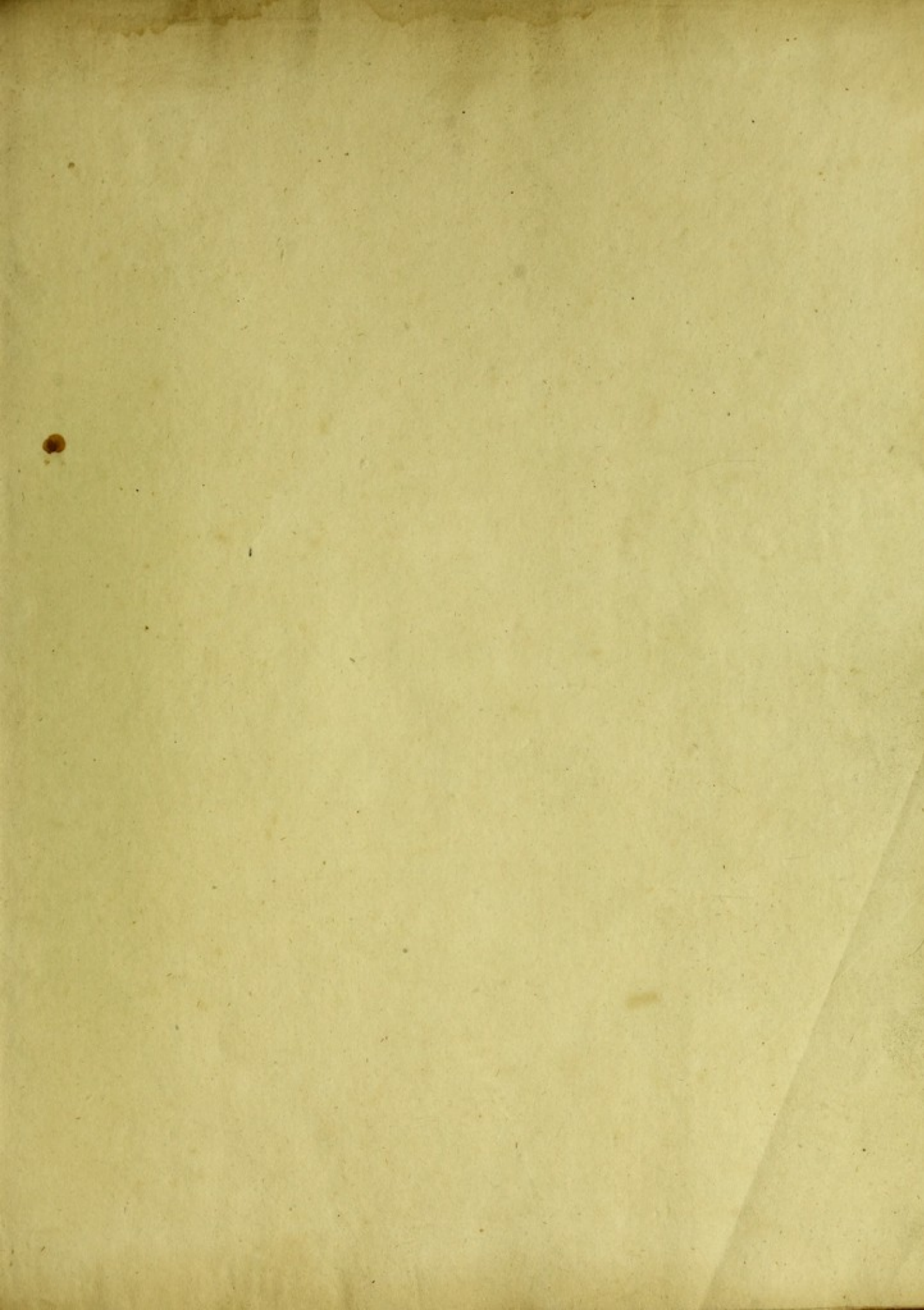
This work has been identified as being free of known restrictions under copyright law, including all related and neighbouring rights and is being made available under the Creative Commons, Public Domain Mark.

You can copy, modify, distribute and perform the work, even for commercial purposes, without asking permission.



Wellcome Collection
183 Euston Road
London NW1 2BE UK
T +44 (0)20 7611 8722
E library@wellcomecollection.org
<https://wellcomecollection.org>



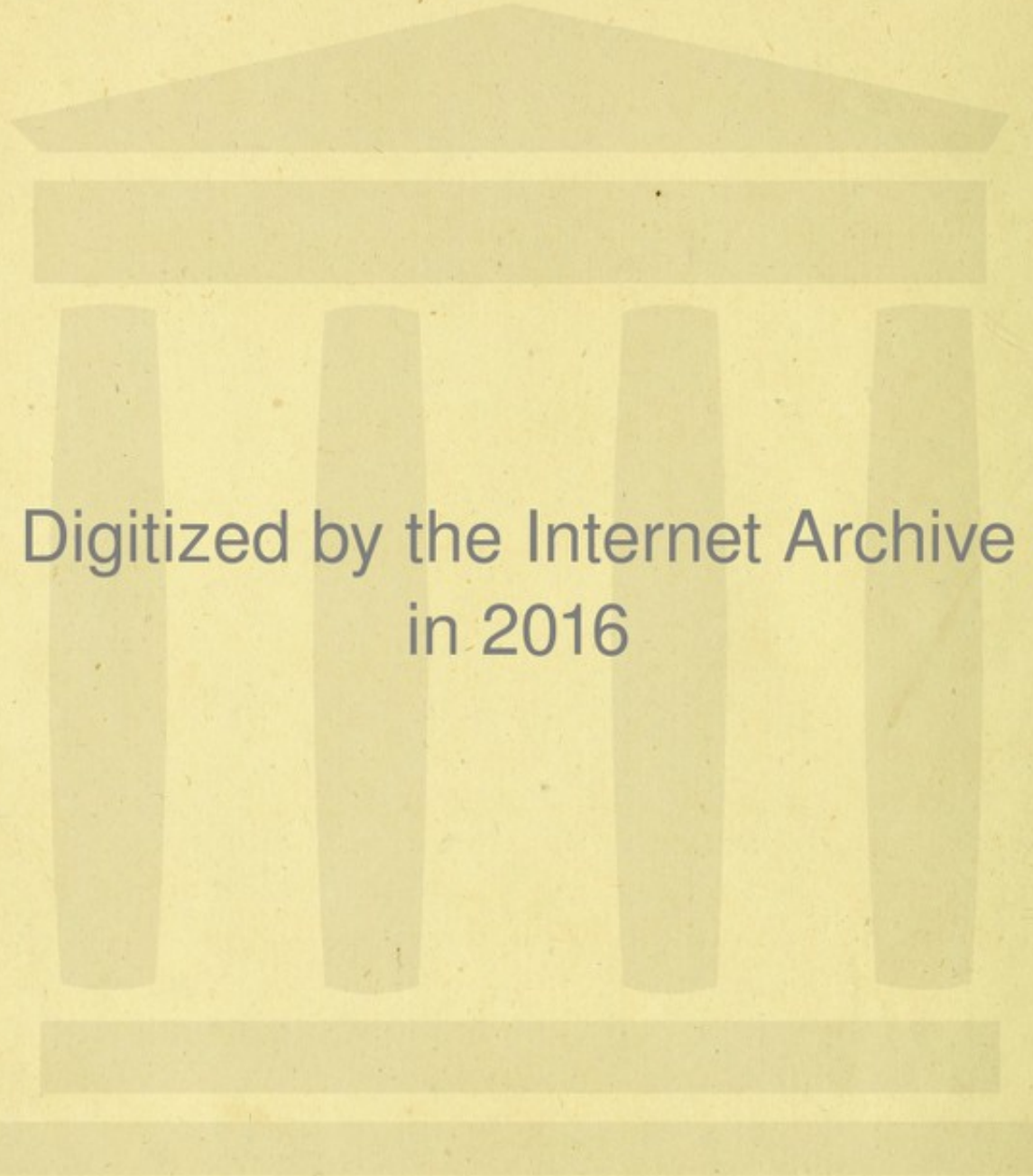


LIBRARY OF THE UNIVERSITY OF TORONTO

DEPT. OF EDUCATION

1910

100



Digitized by the Internet Archive
in 2016

<https://archive.org/details/b22033579>

D I C T I O N N A I R E

R A I S O N N É

D E P H Y S I Q U E ,

P A R M. J. B R I S S O N ,

Membre de l'INSTITUT NATIONAL des Sciences et des Arts, et Professeur
de Physique et de Chymie aux Écoles Centrales de Paris.

S E C O N D E É D I T I O N ,

R E V U E , C O R R I G É E E T A U G M E N T É E P A R L ' A U T E U R .

PLANCHES.



A P A R I S ,

A LA LIBRAIRIE ÉCONOMIQUE, RUE DE LA HARPE, N.º 117.

CHEZ MAGIMEL, LIBRAIRE, QUAI DES AUGUSTINS, N.º 73.

1800.

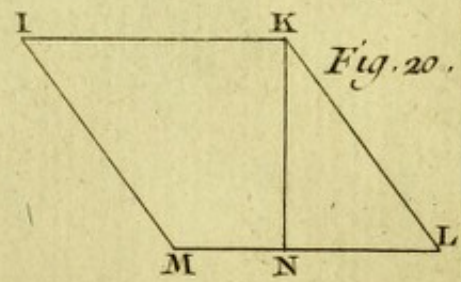
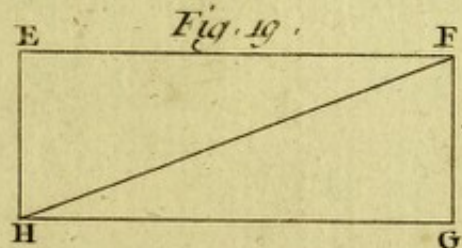
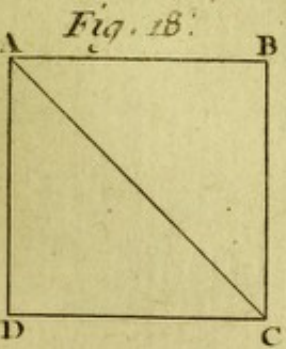
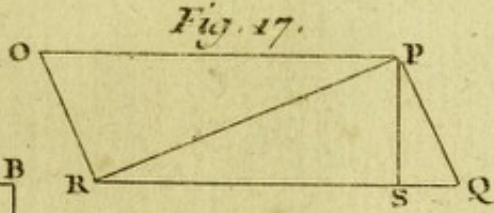
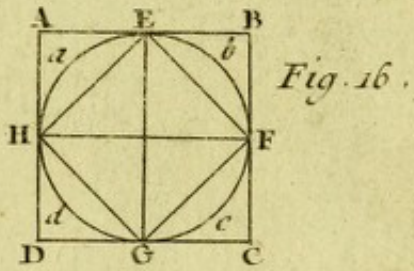
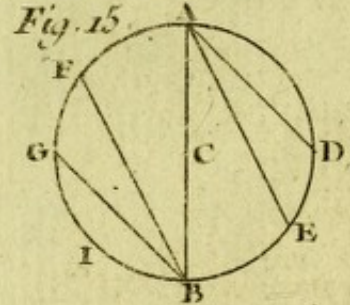
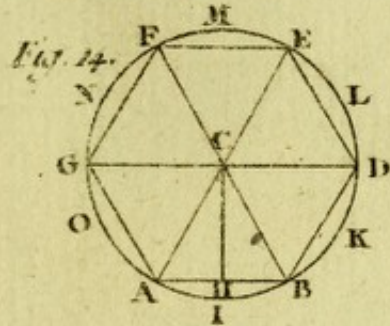
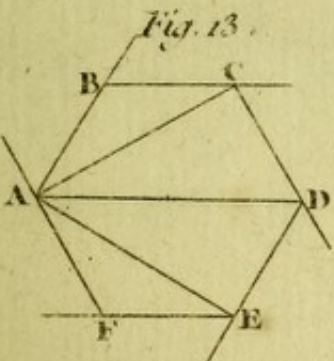
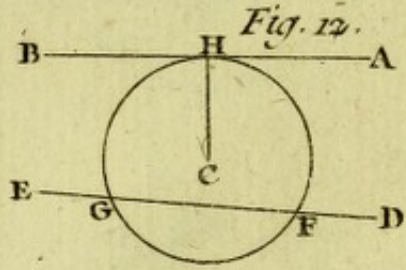
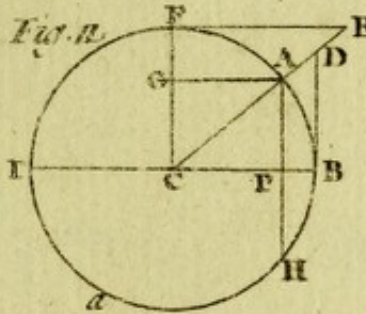
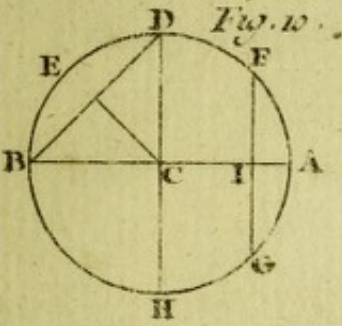
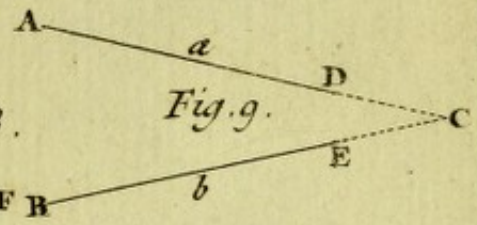
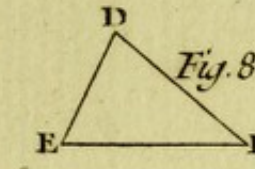
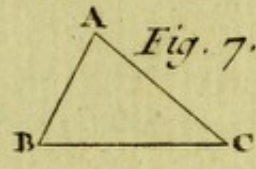
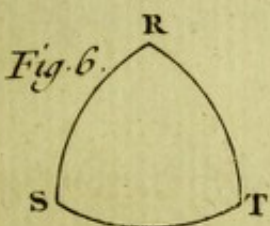
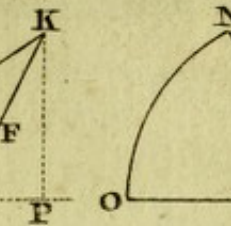
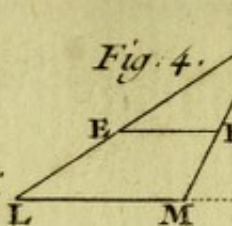
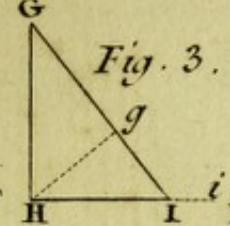
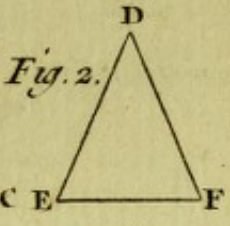
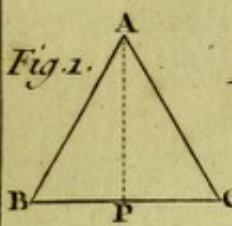


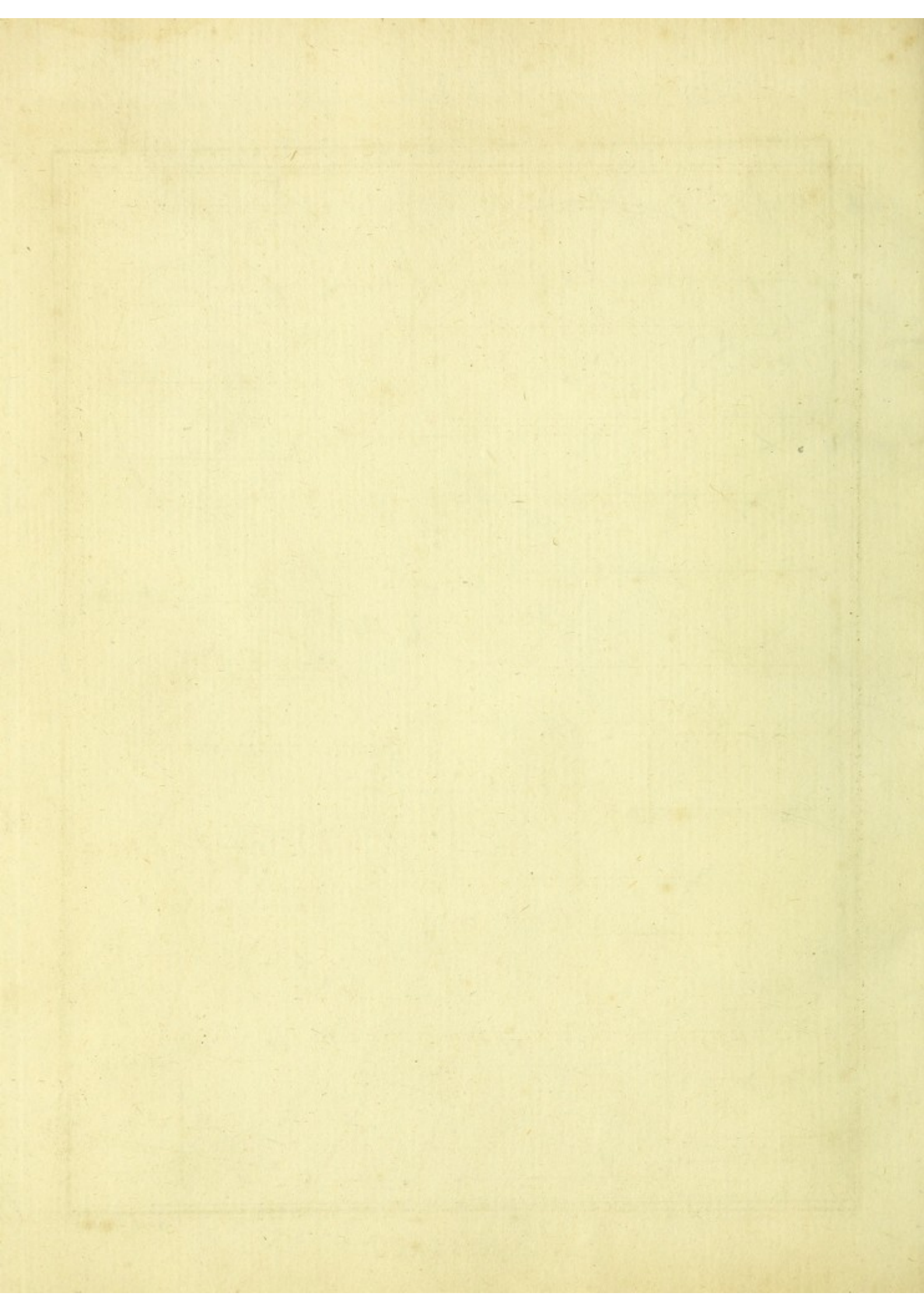
AVERTISSEMENT.

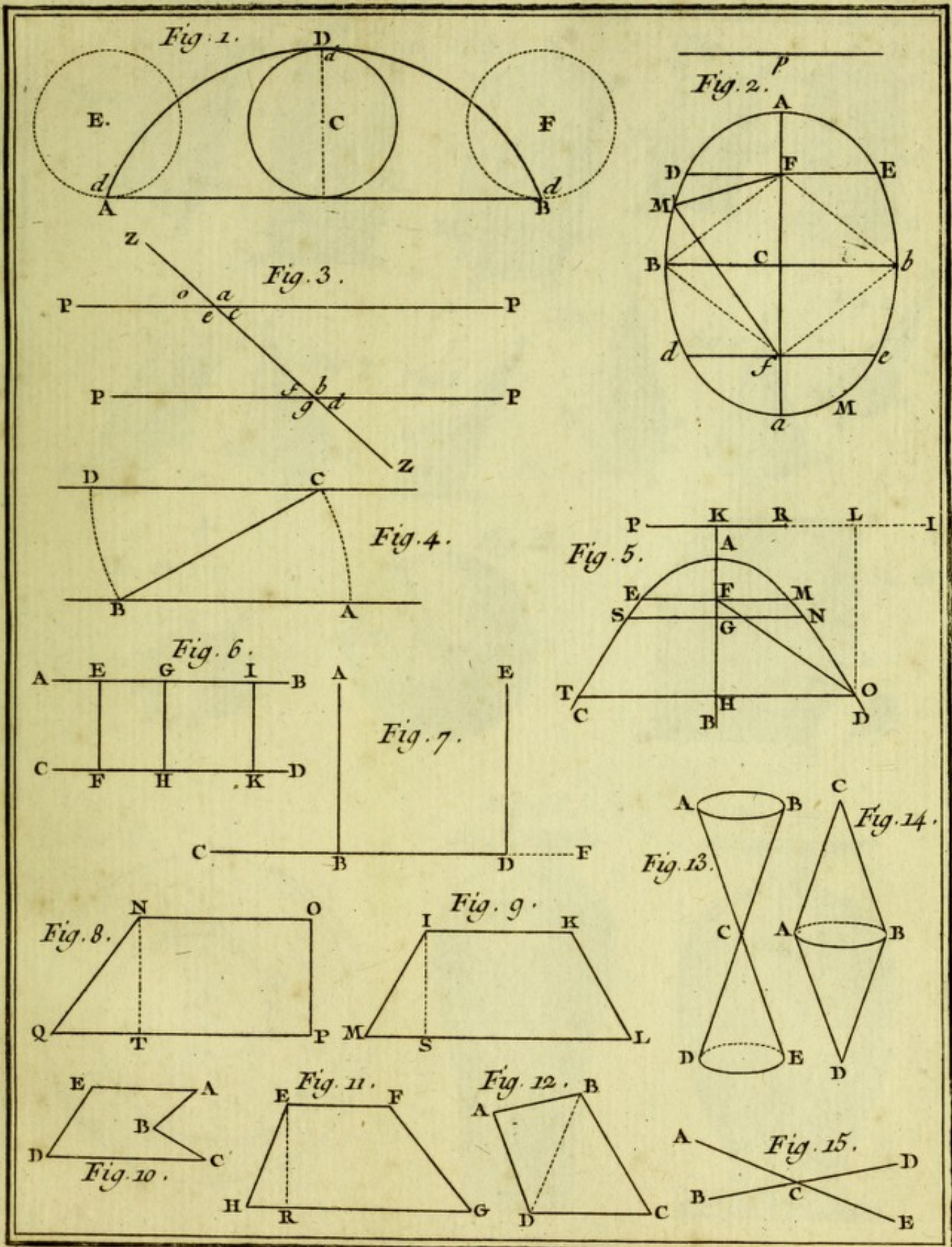
On s'est déterminé à faire, des Planches de ce Dictionnaire, un Volume séparé, afin d'en rendre l'usage plus commode au Lecteur. On en va sentir la raison. La plupart de ces Planches appartiennent également à tous les Volumes. Souvent la même Figure est destinée à l'intelligence de plusieurs articles, dont les uns sont dans le Tome premier et les autres dans le second, etc. Pour joindre à chacun de ces Volumes les Figures qui lui sont nécessaires, il eût donc fallu en graver un grand nombre deux fois; ce qui aurait multiplié les Planches, augmenté la dépense, et, en conséquence, le prix de l'Ouvrage, en pure perte pour l'Acheteur, puisque dans ce cas-là il n'aurait rien de plus que ce qu'il a: il aurait seulement la même chose deux fois, ce qui lui serait inutile. Voilà la raison pour laquelle on a fait de ces Planches un Volume à part. Quand

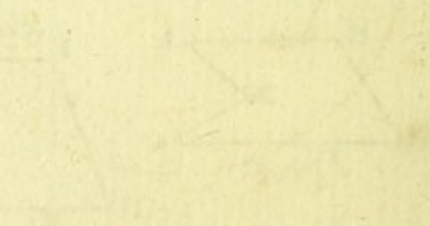
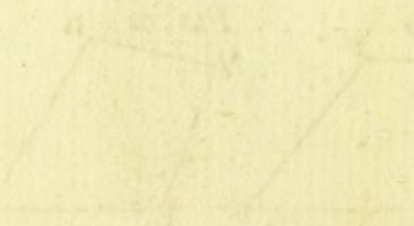
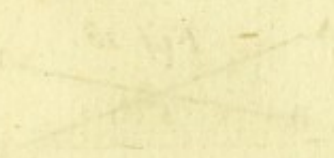
AVERTISSEMENT.

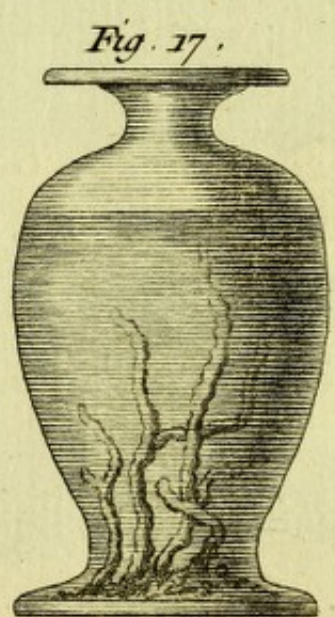
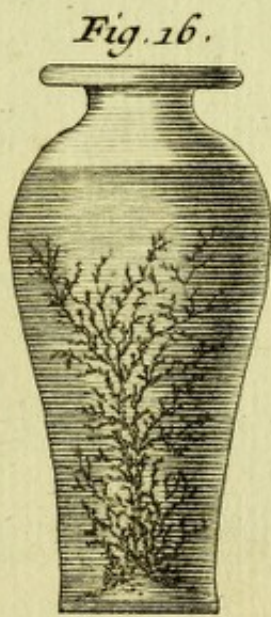
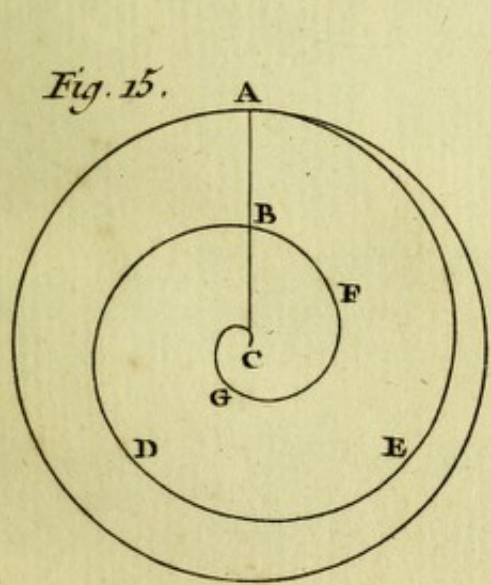
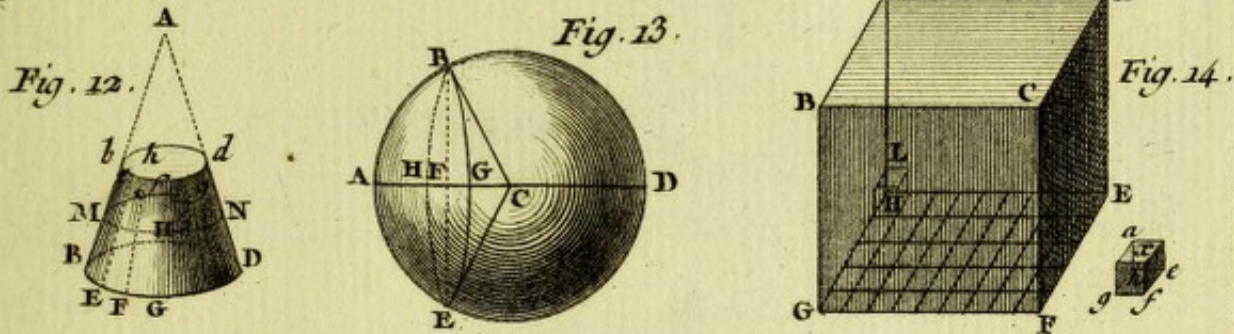
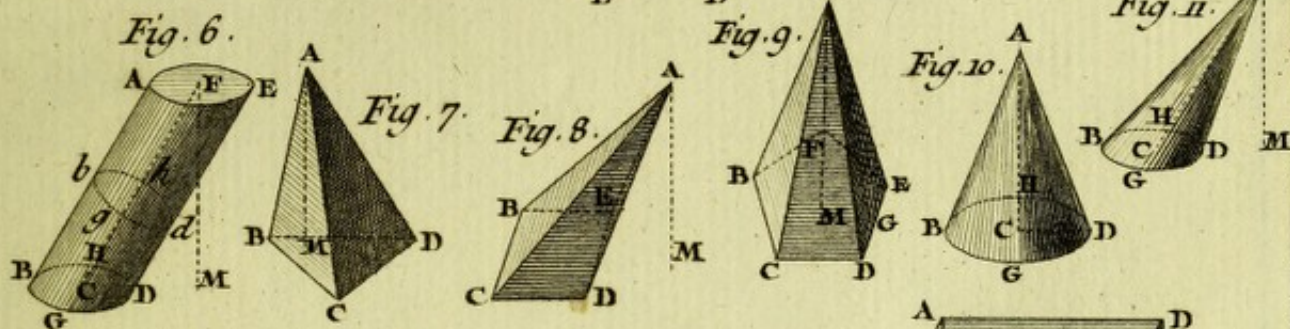
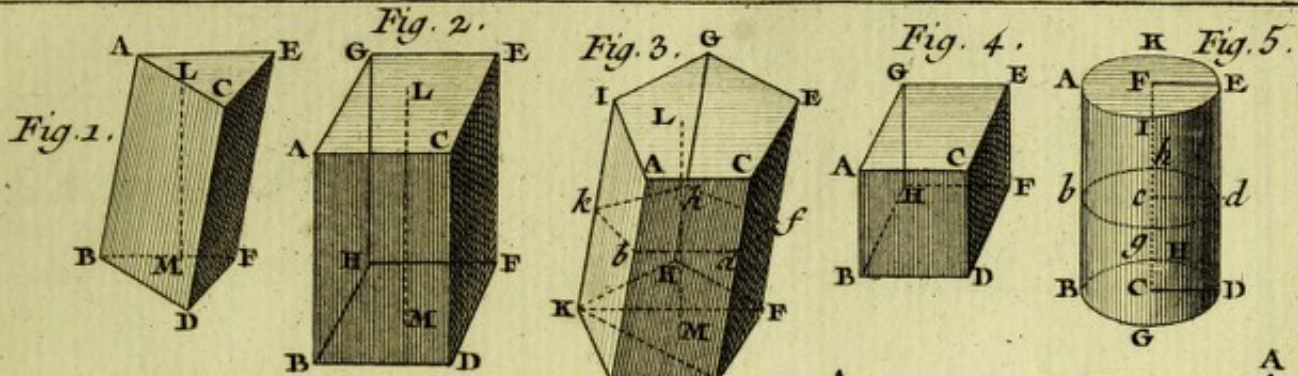
ou en fera usage, elles auront la commodité de celles
qui sortent du livre, et n'auront pas, comme ces der-
nières, l'inconvénient de se déchirer, n'ayant pas été
pliées.

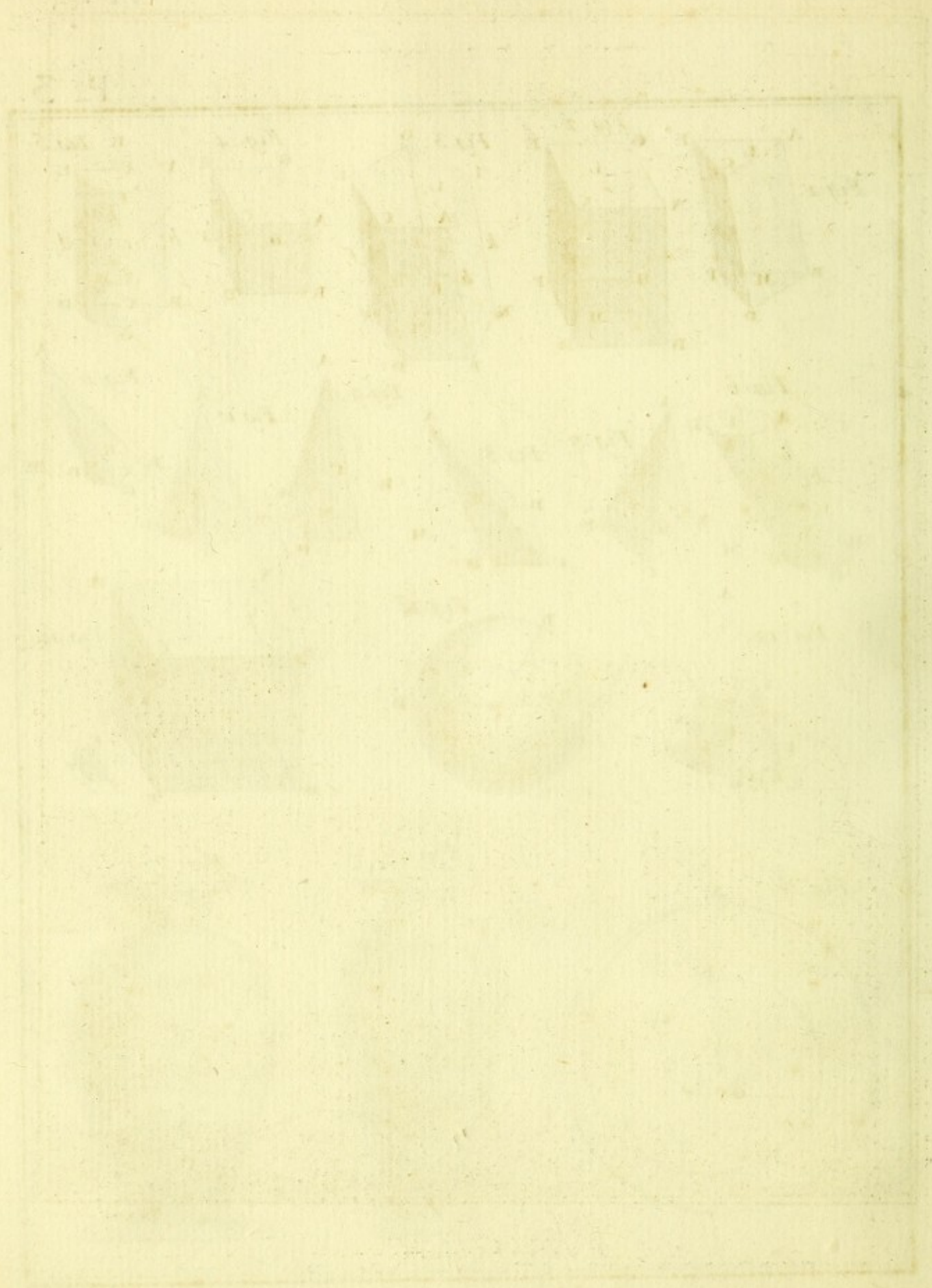


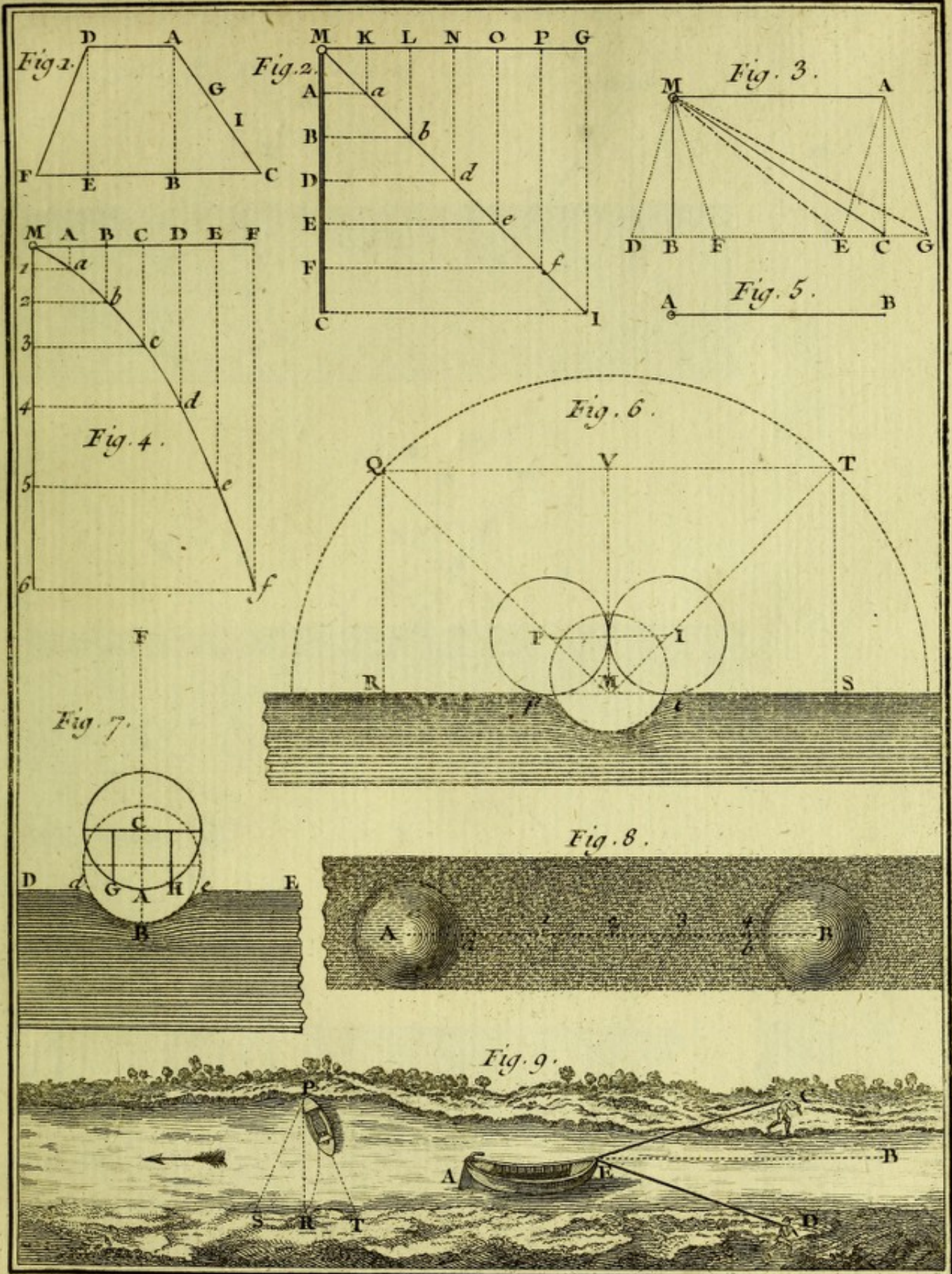


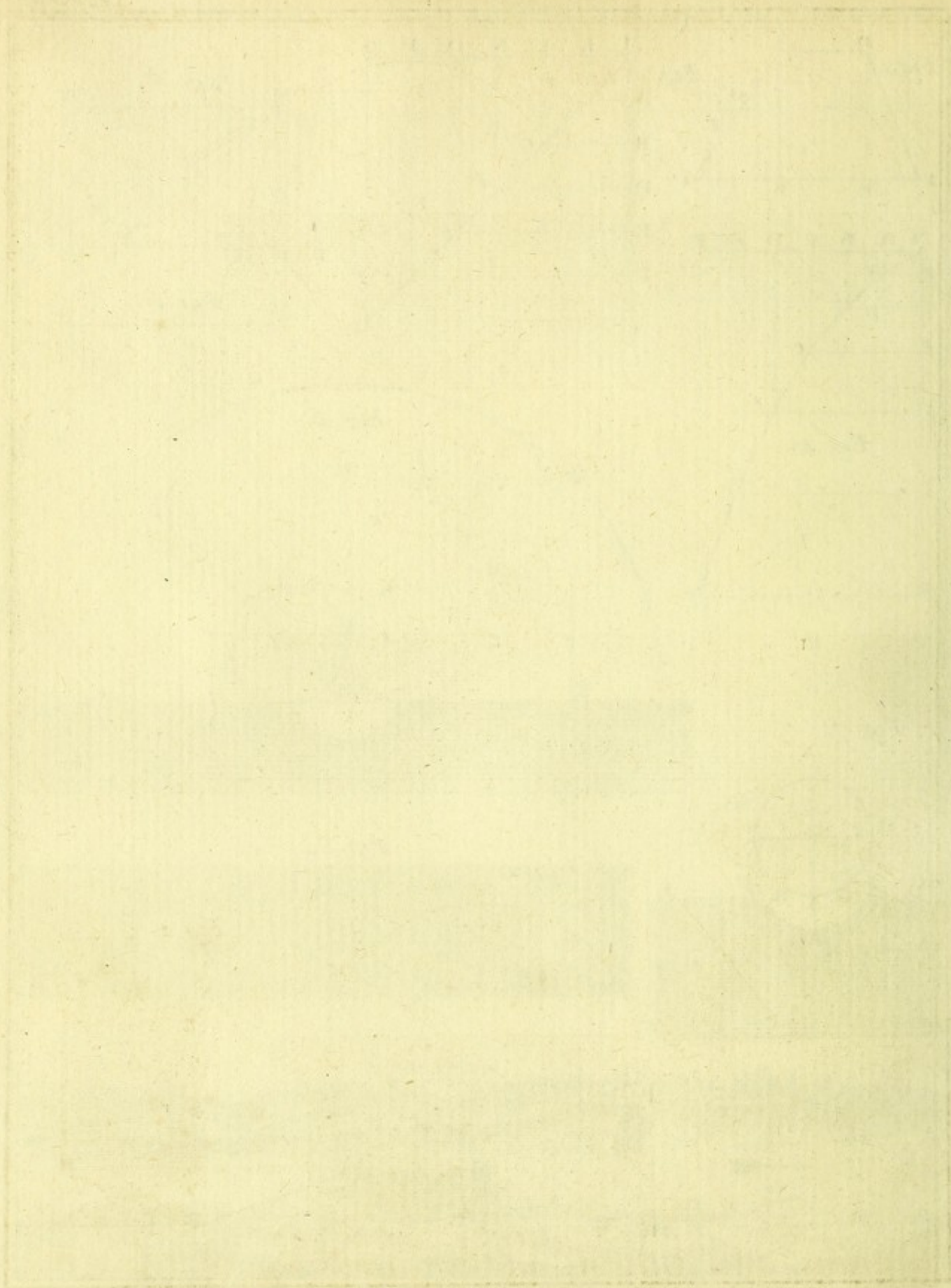




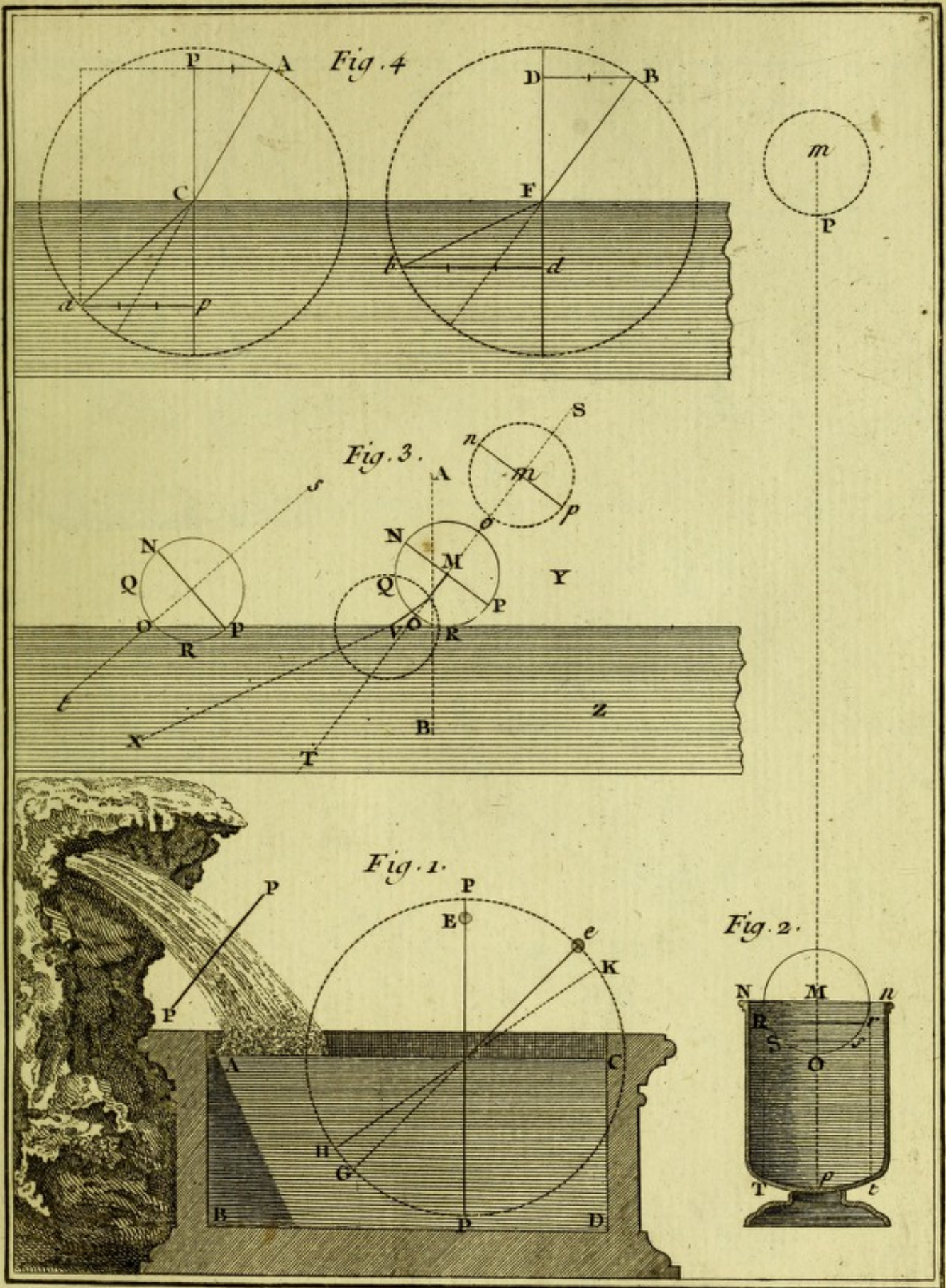






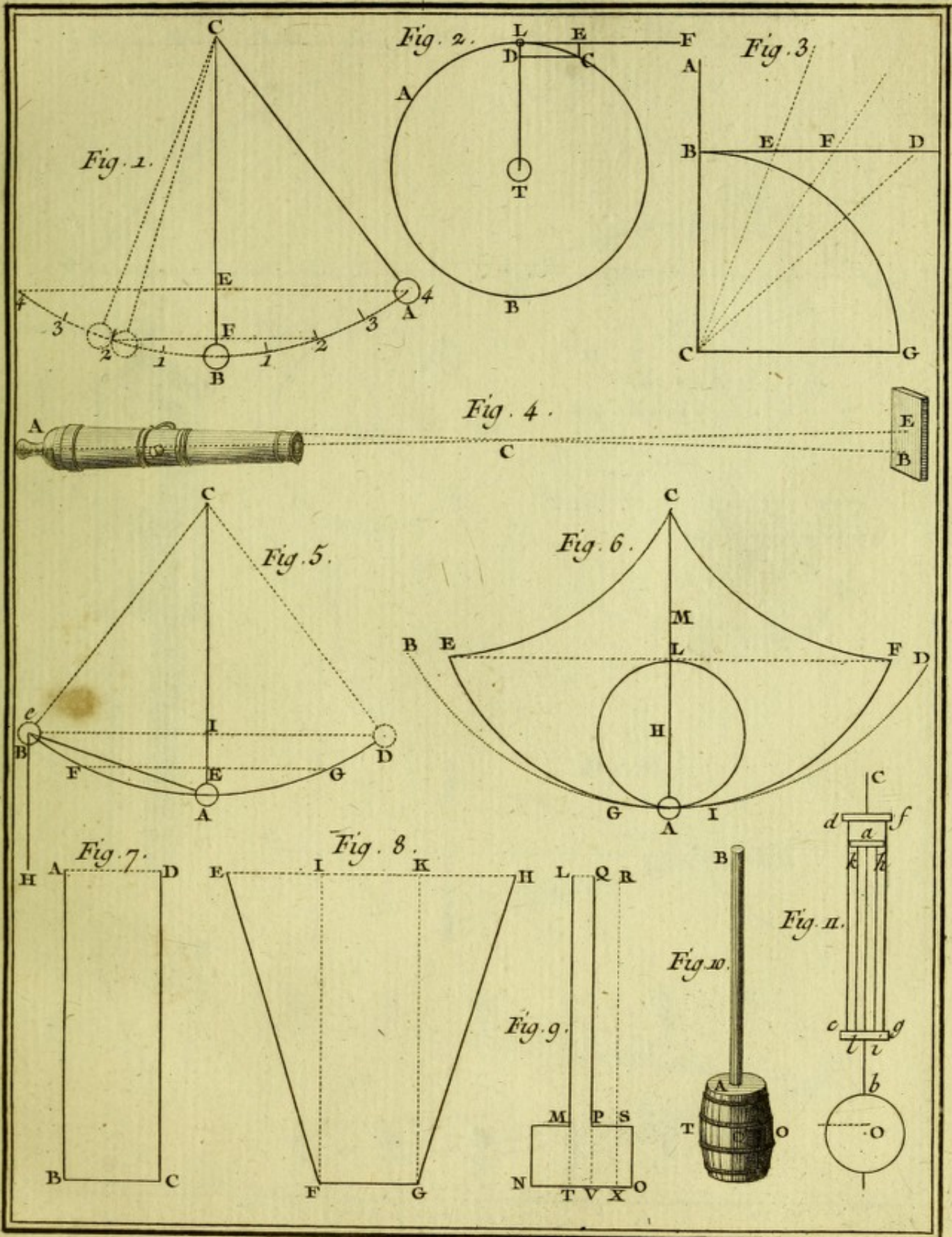


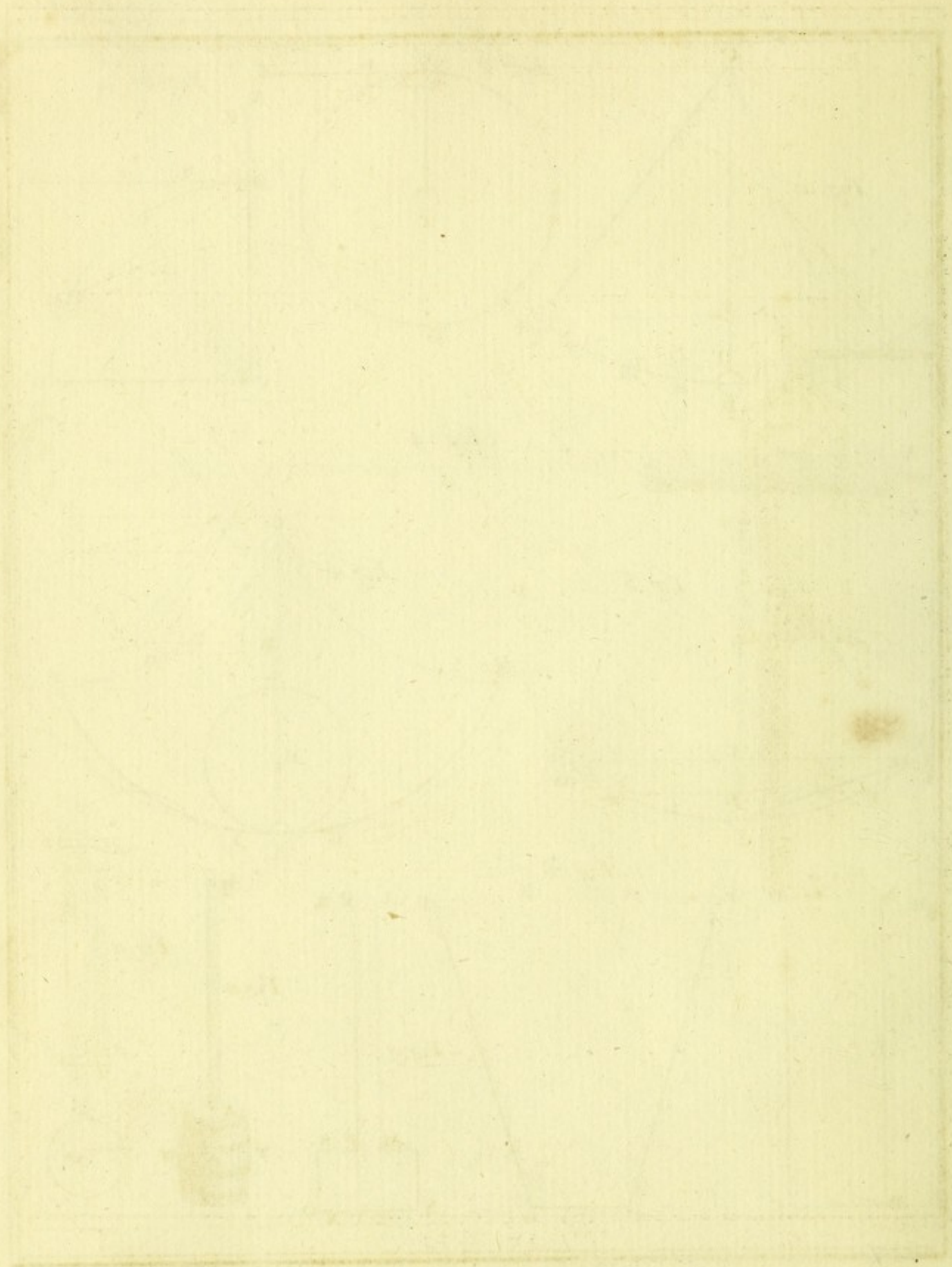
1871

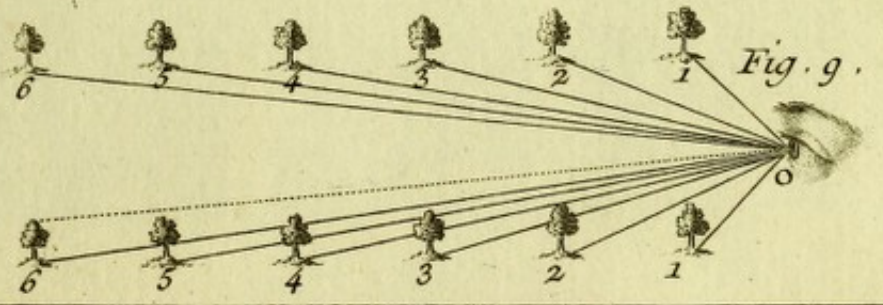
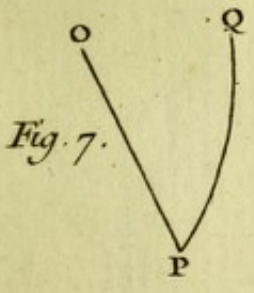
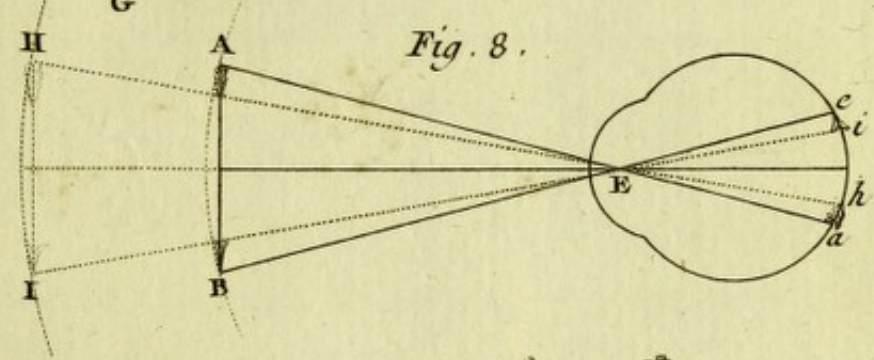
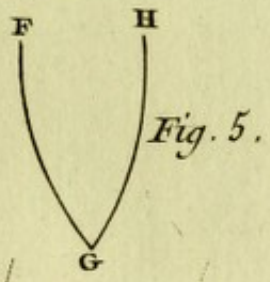
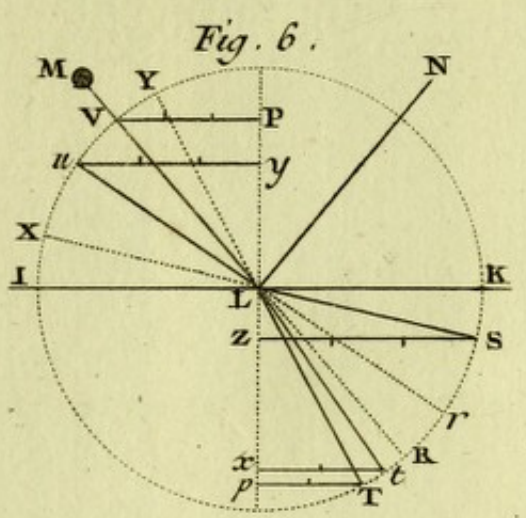
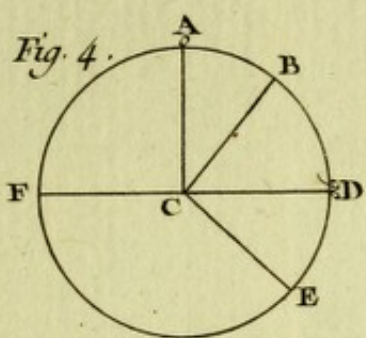
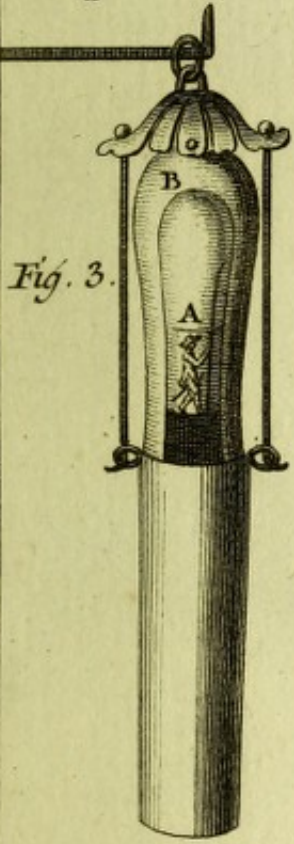
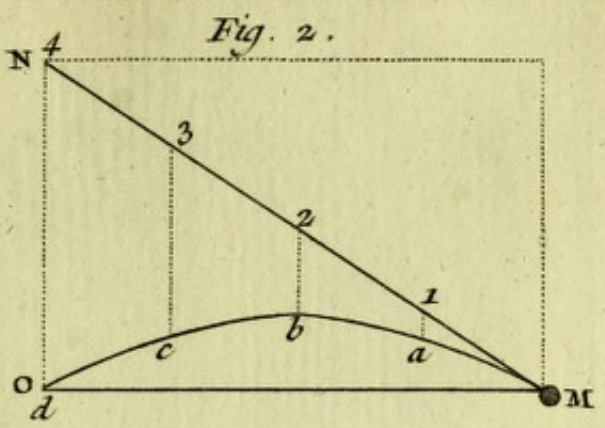
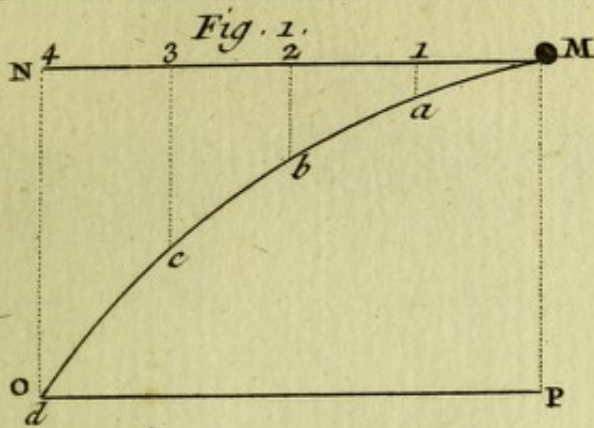


Physique.

Benard Duxcit







Andréas Jussé.

Fig. 4.

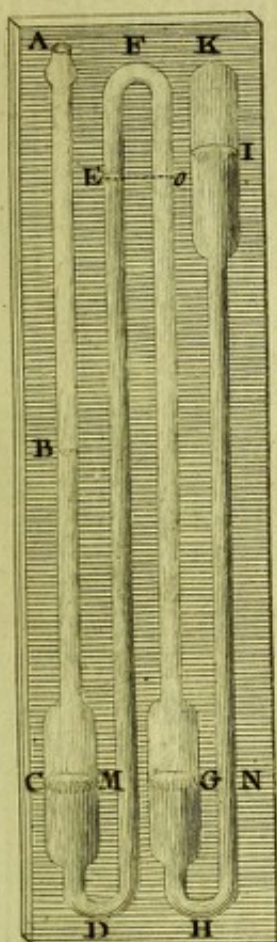


Fig. 3.

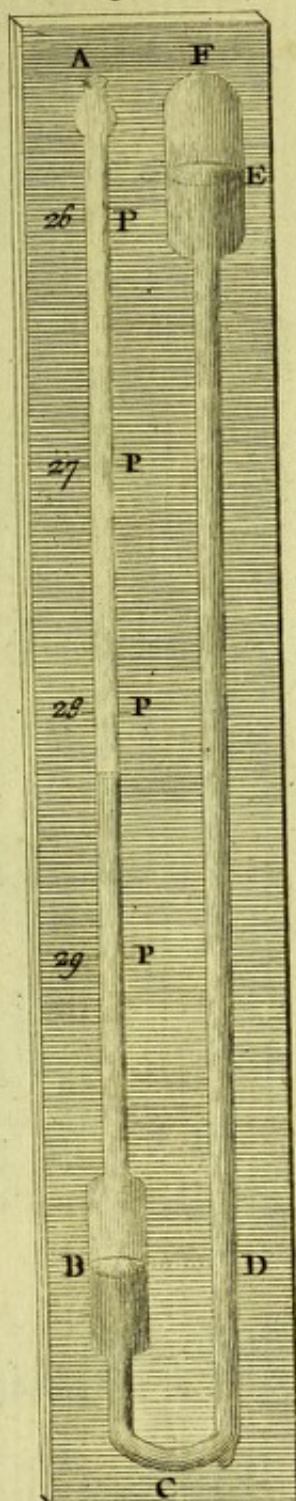


Fig. 2.

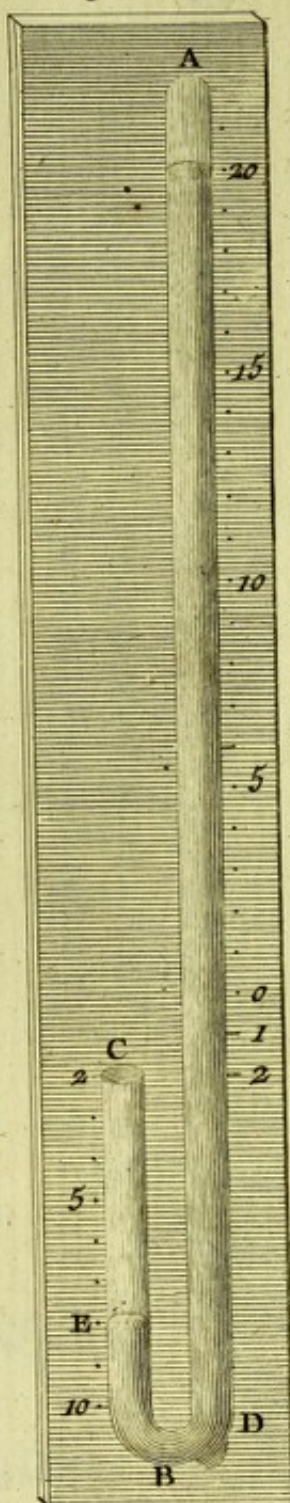


Fig. 1.

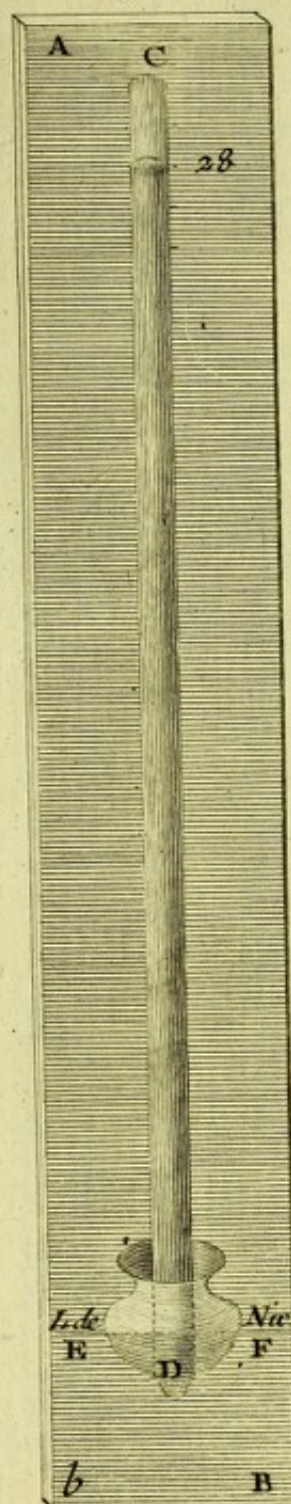
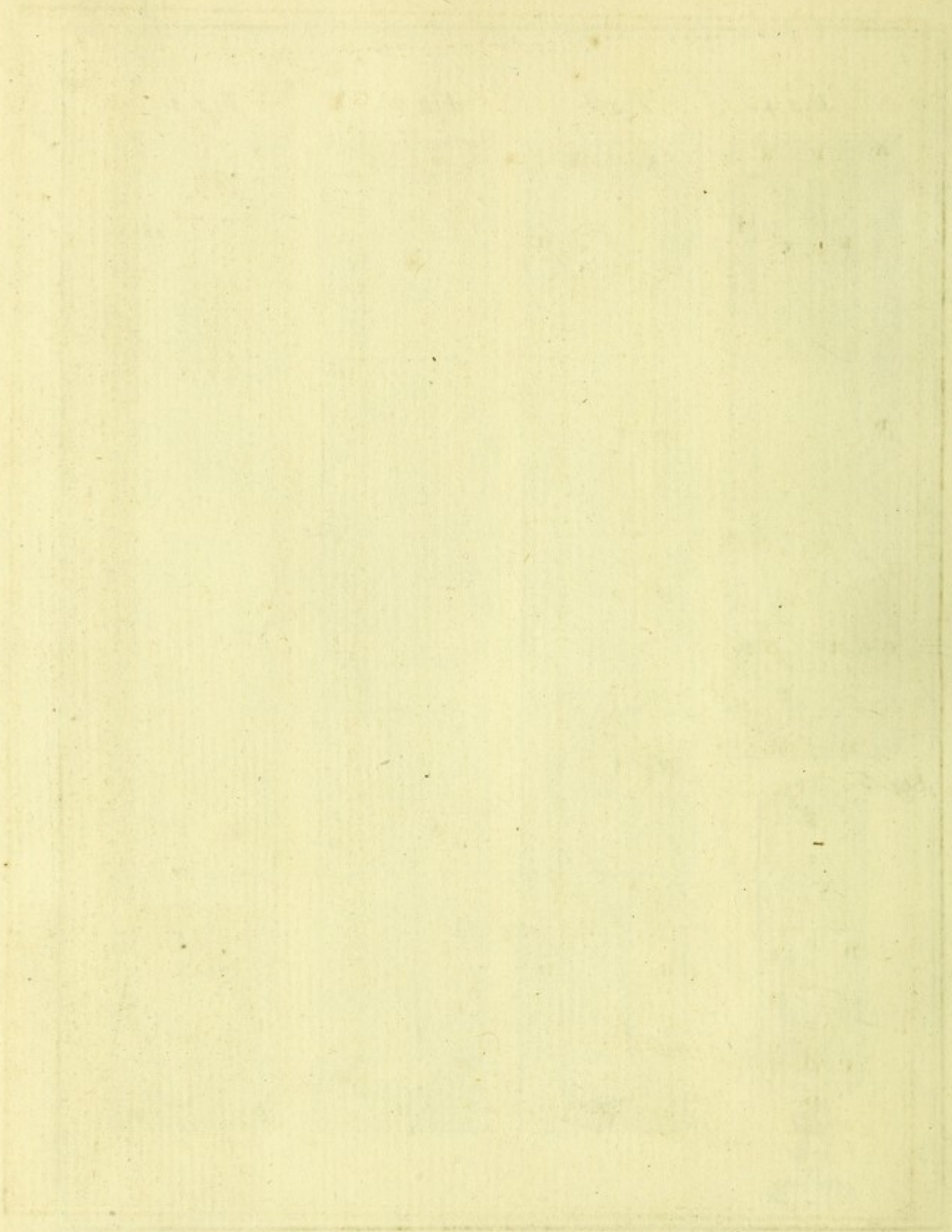
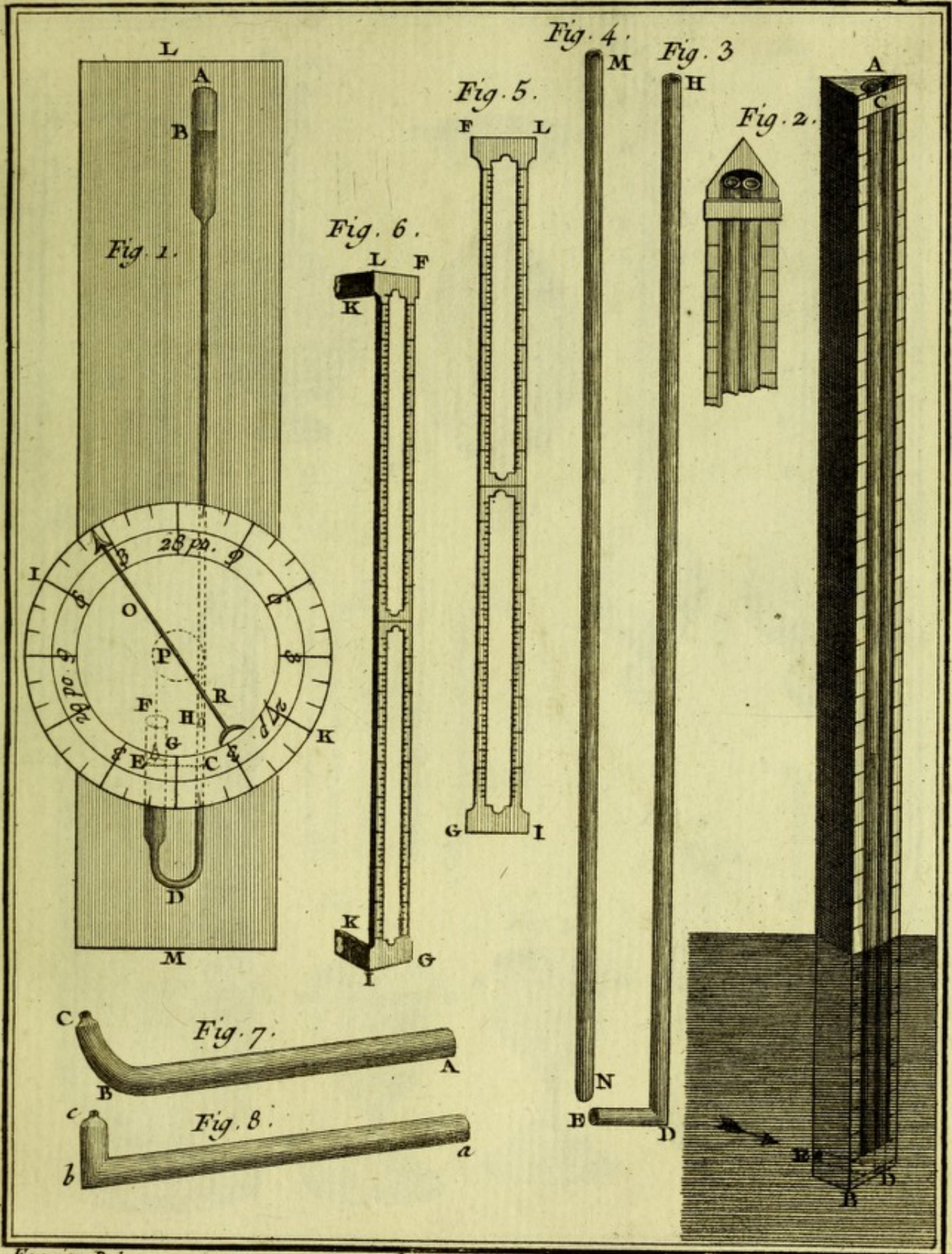


Fig. 5.



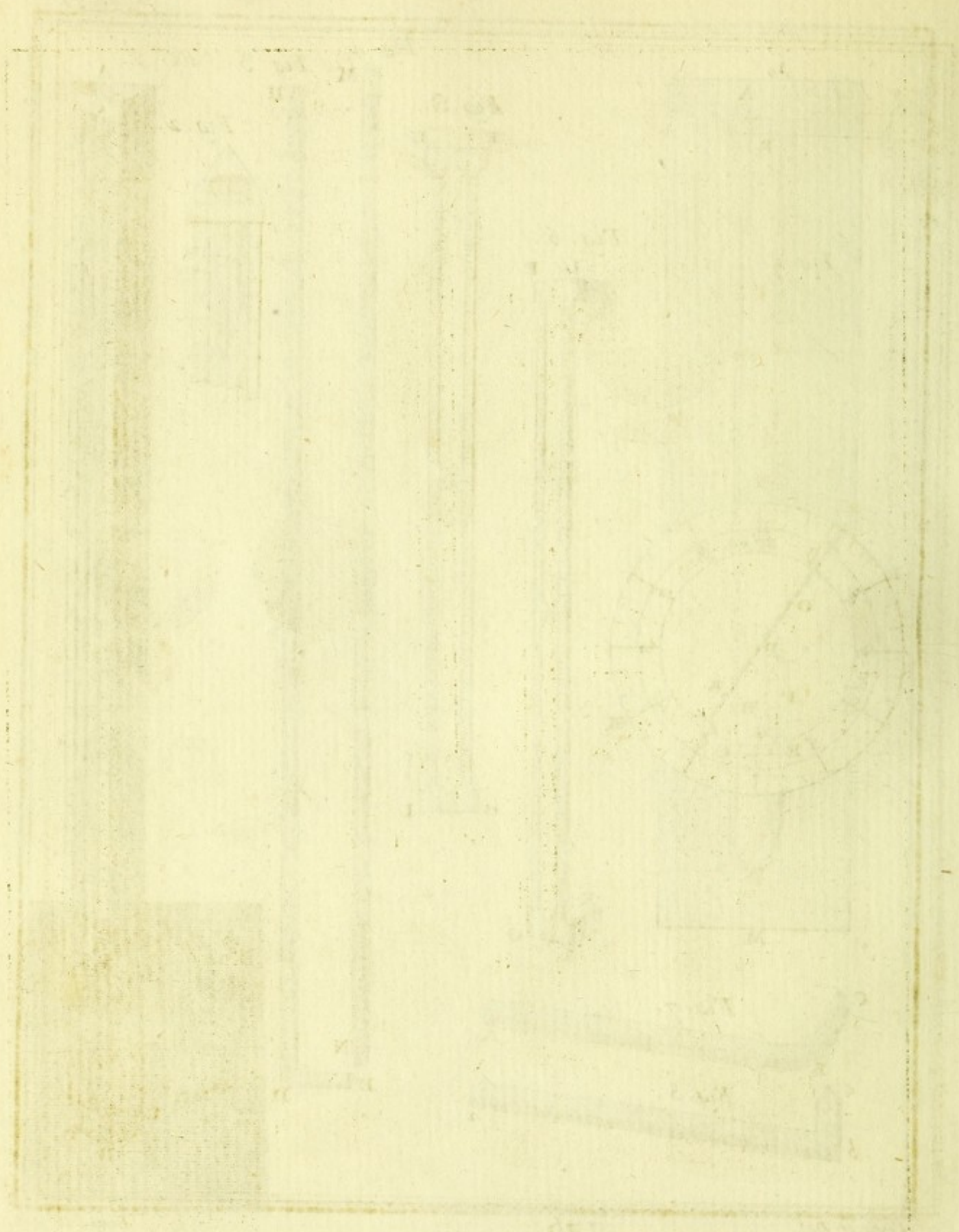


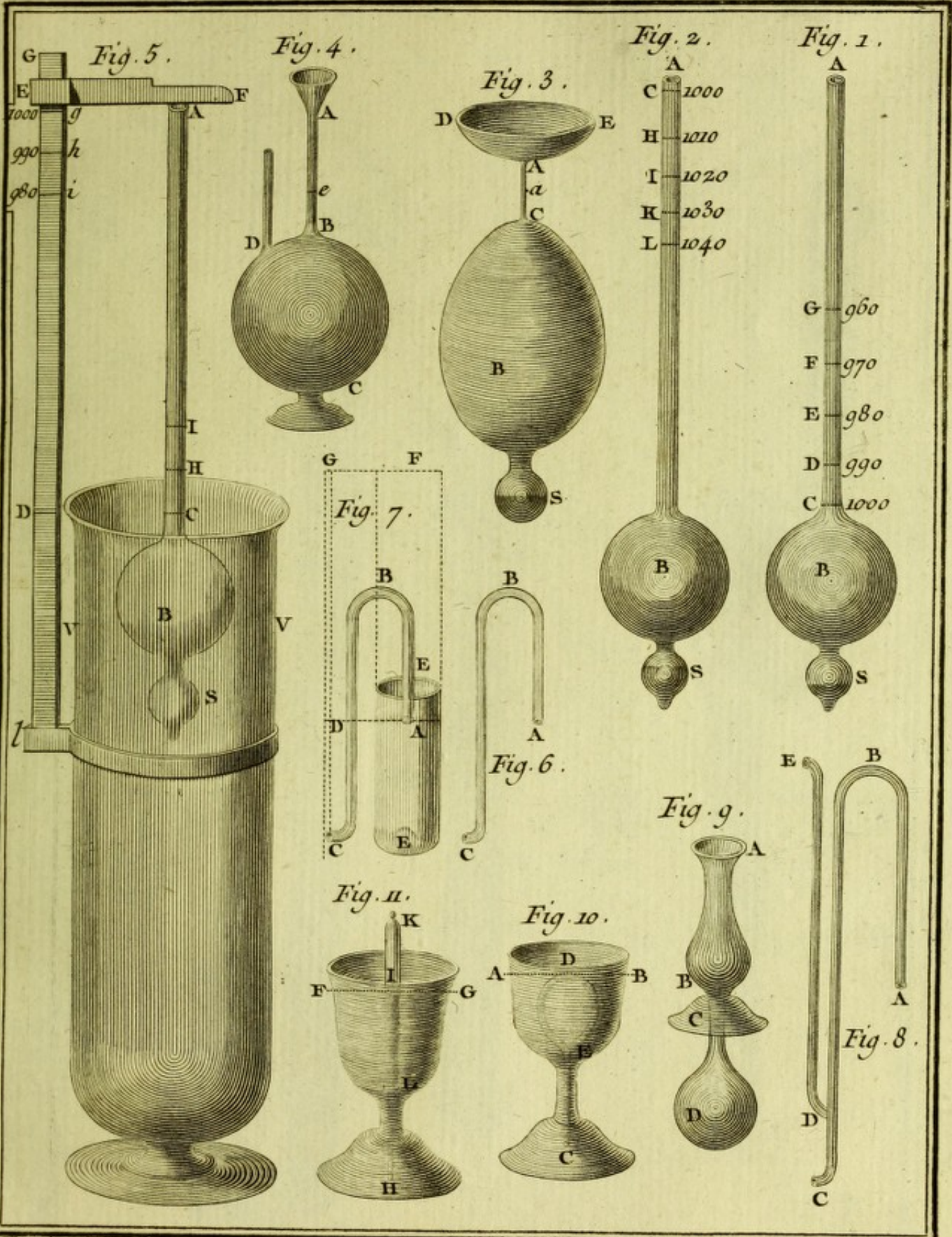


Fossier Del.

Physique.

Benard Dircxit.

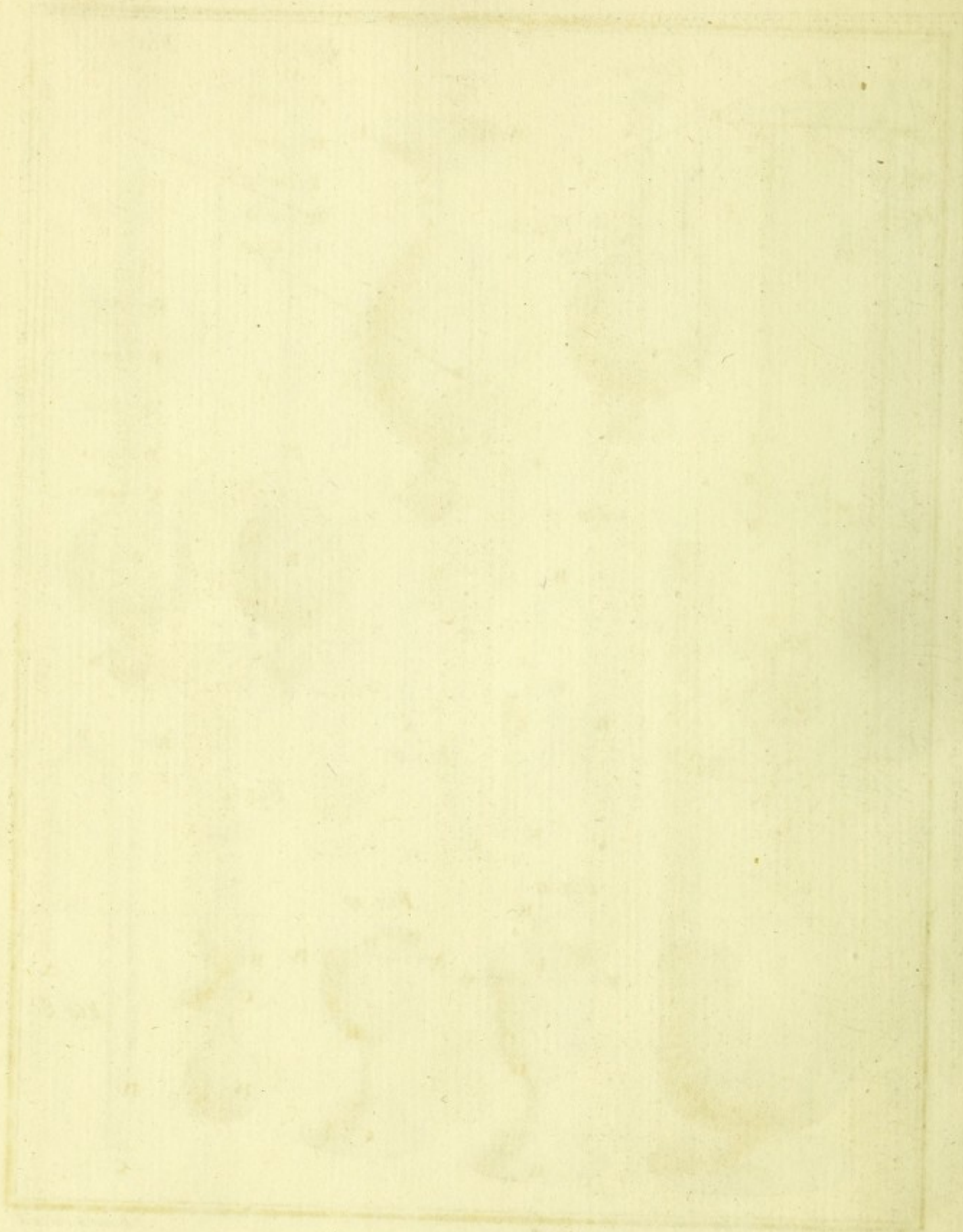




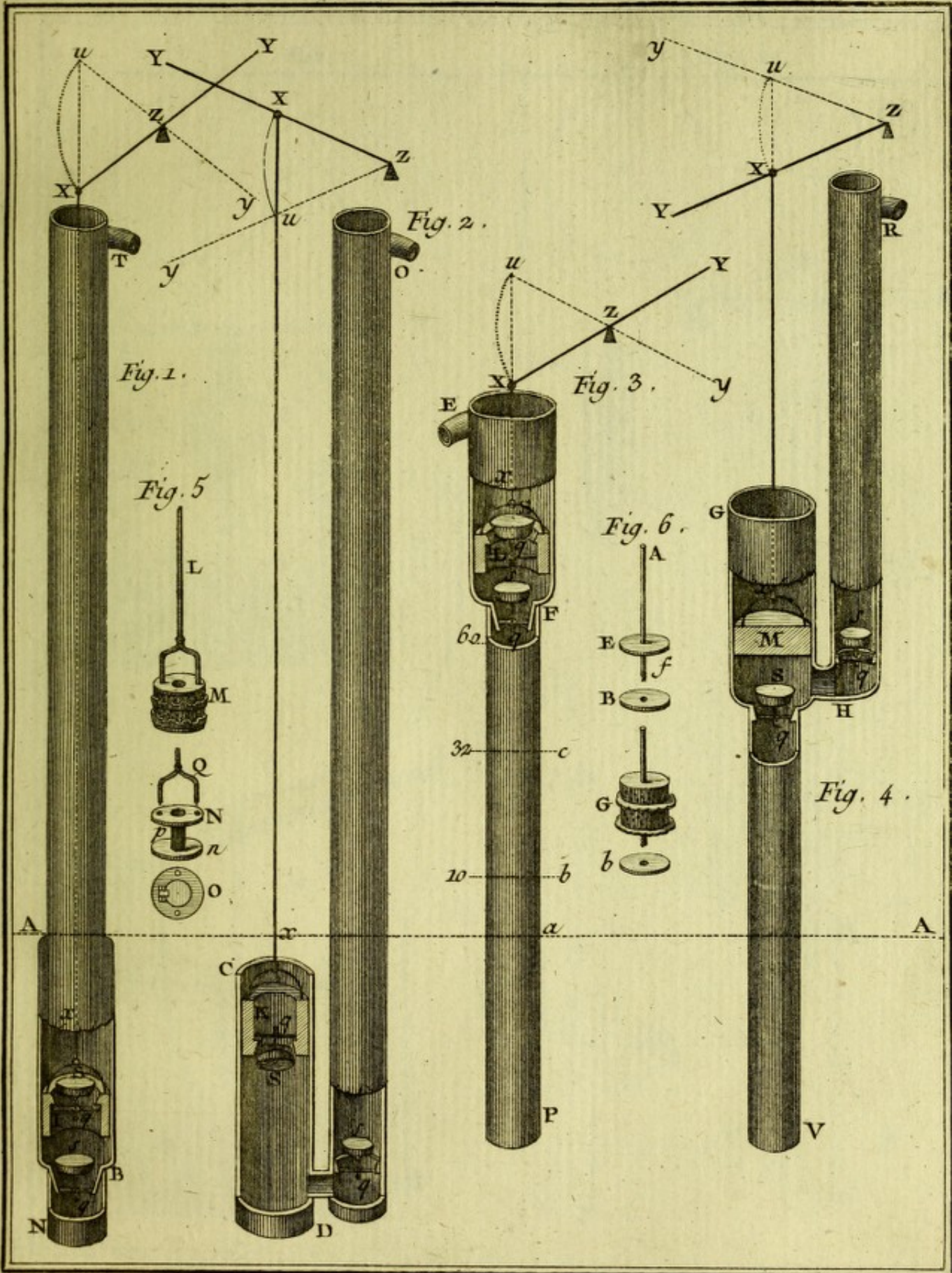
Fossier Del.

Benard Dixcit.

Physique.



17



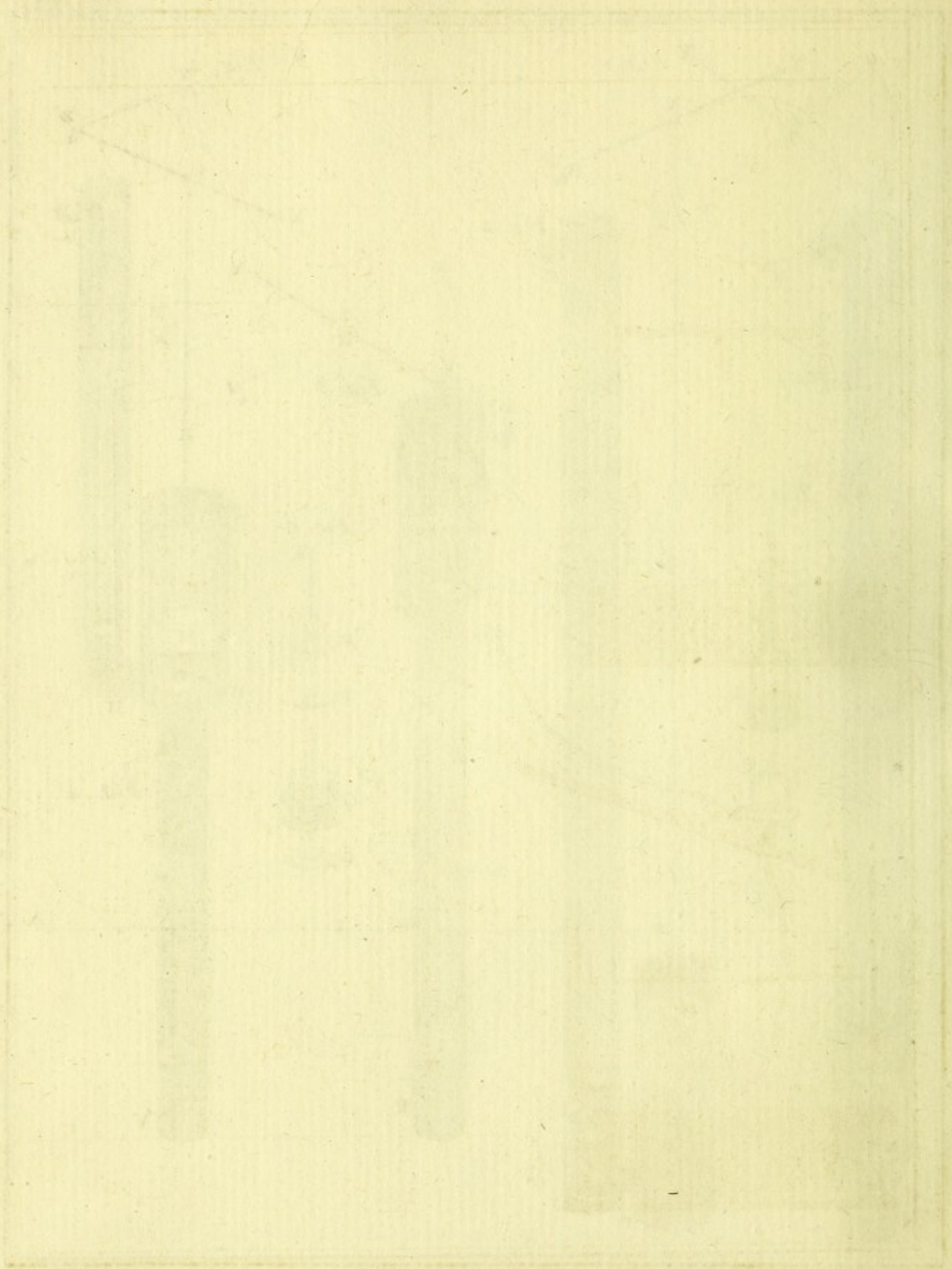


Fig. 1.

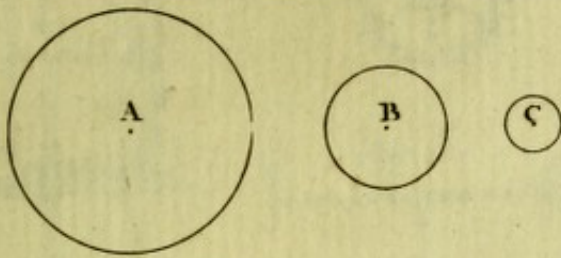


Fig. 2.

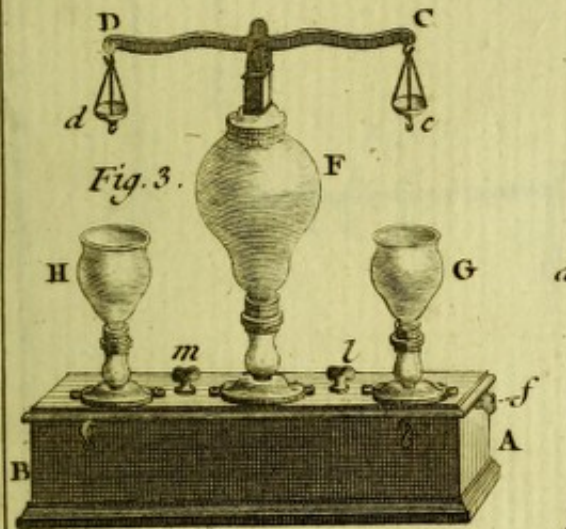
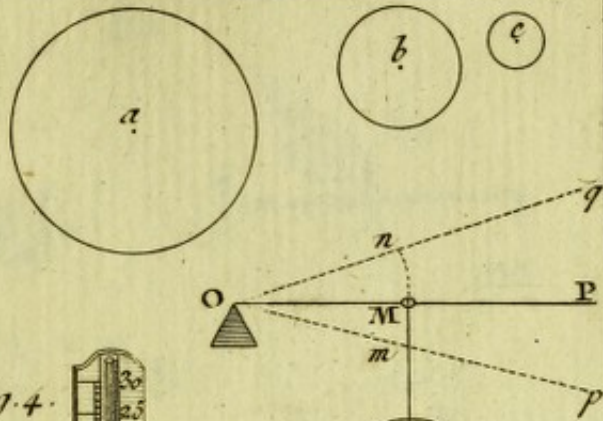


Fig. 4.

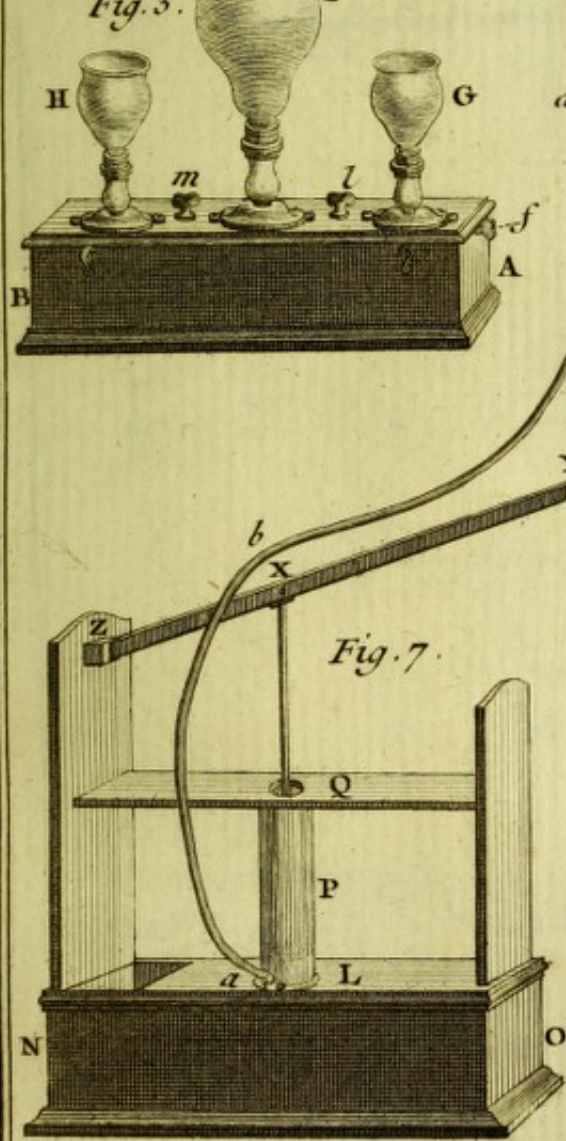
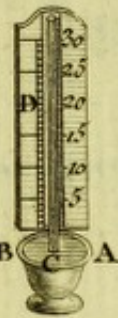


Fig. 7.

Fig. 6.

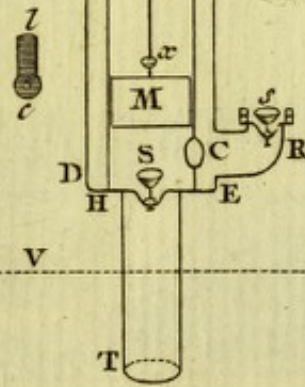
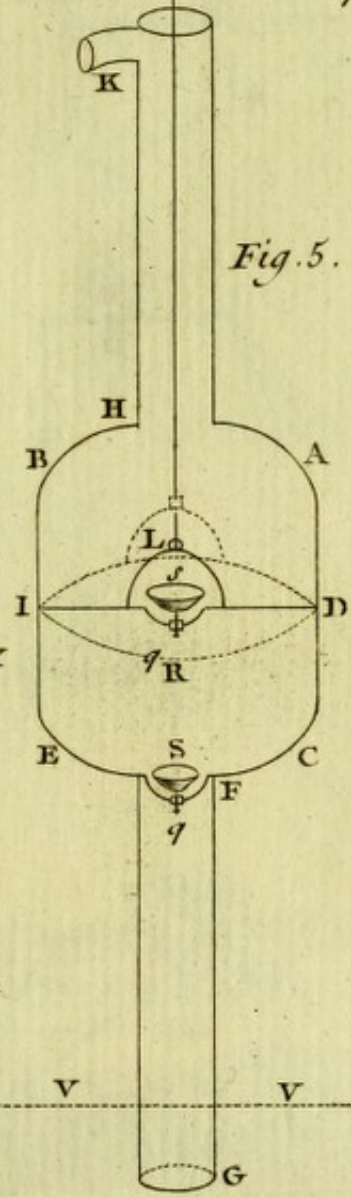
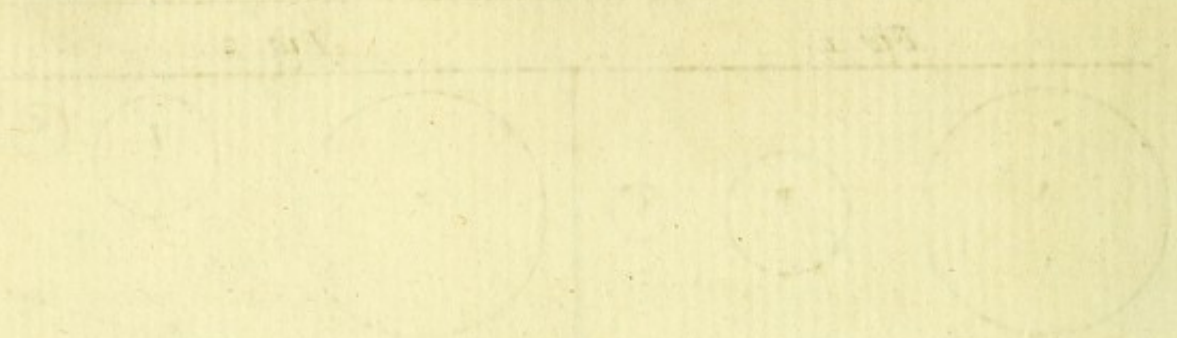
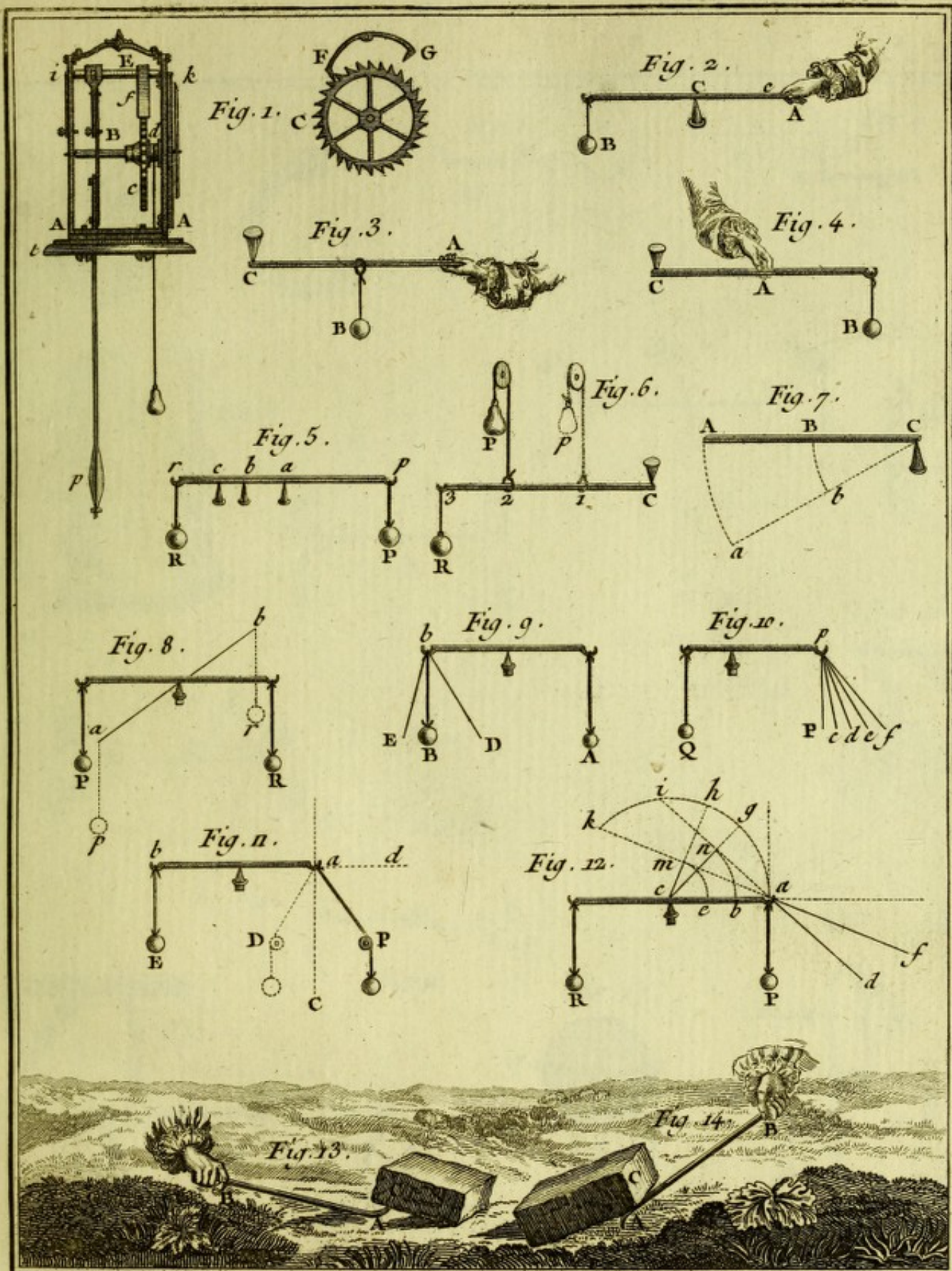
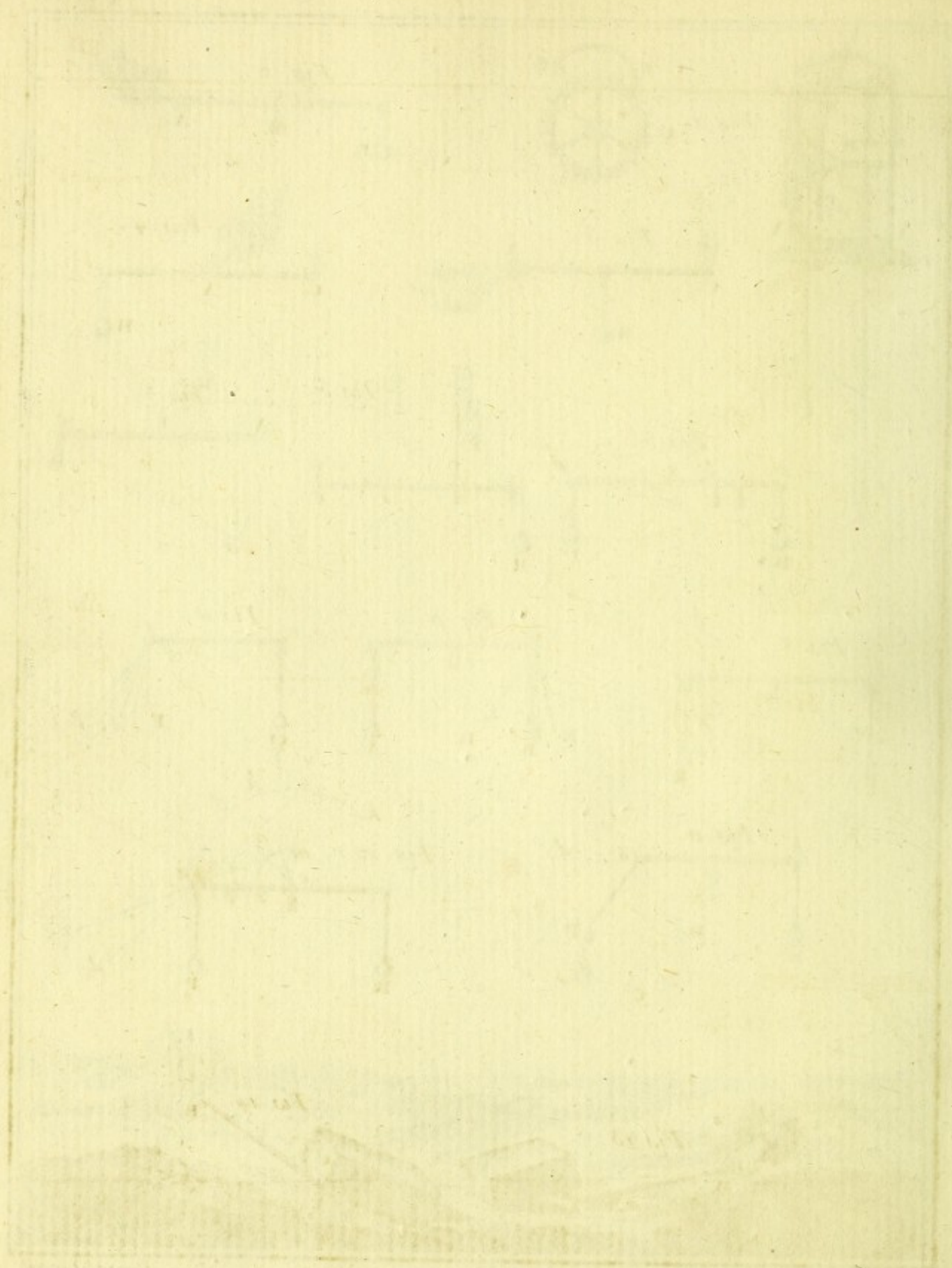


Fig. 5.









PLAN

Fig. 1.



Fig. 2.

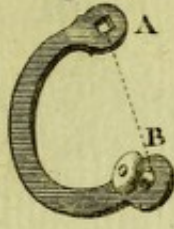


Fig. 3.

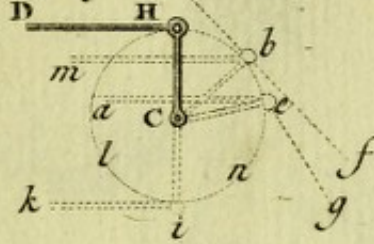


Fig. 4.

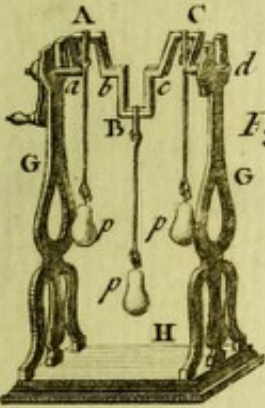
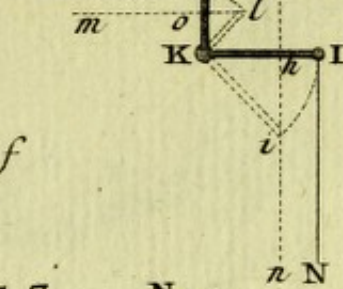


Fig. 5.

Fig. 6.

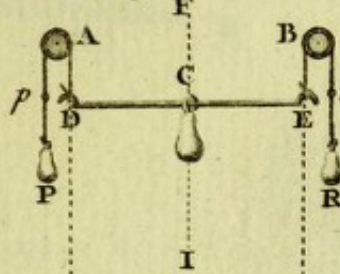


Fig. 7.

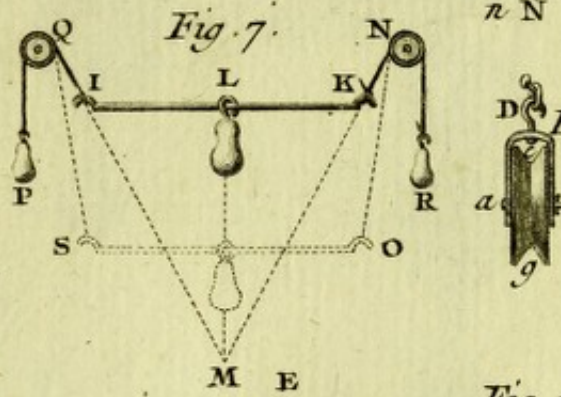


Fig. 15.

Fig. 16.

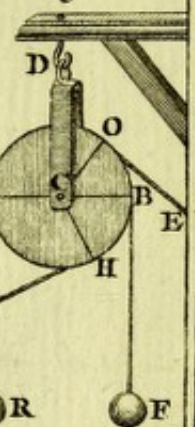


Fig. 8.

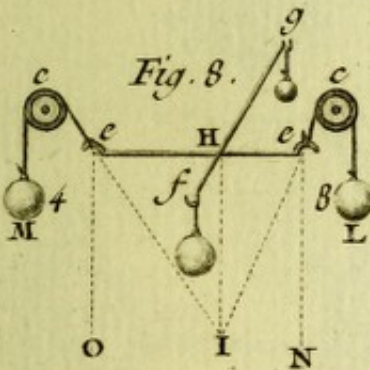


Fig. 10.

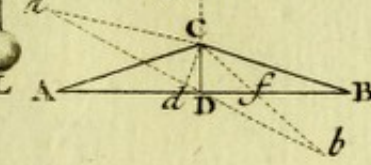


Fig. 12.

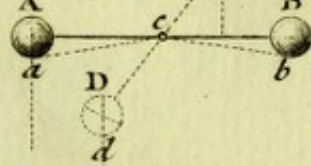


Fig. 11.

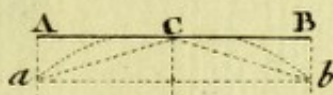


Fig. 17.

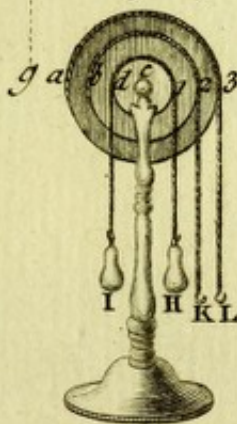


Fig. 9.

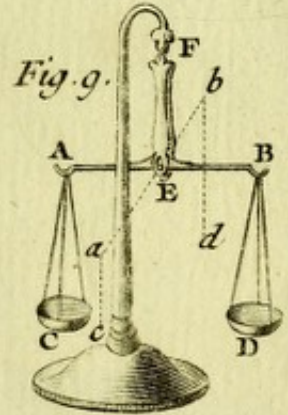


Fig. 14.

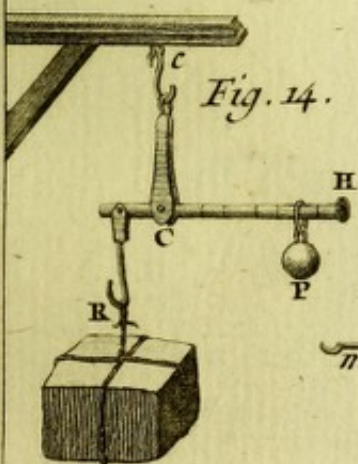
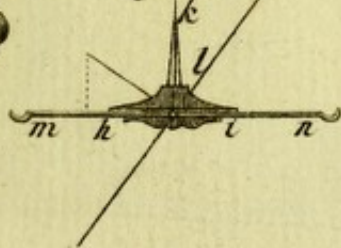
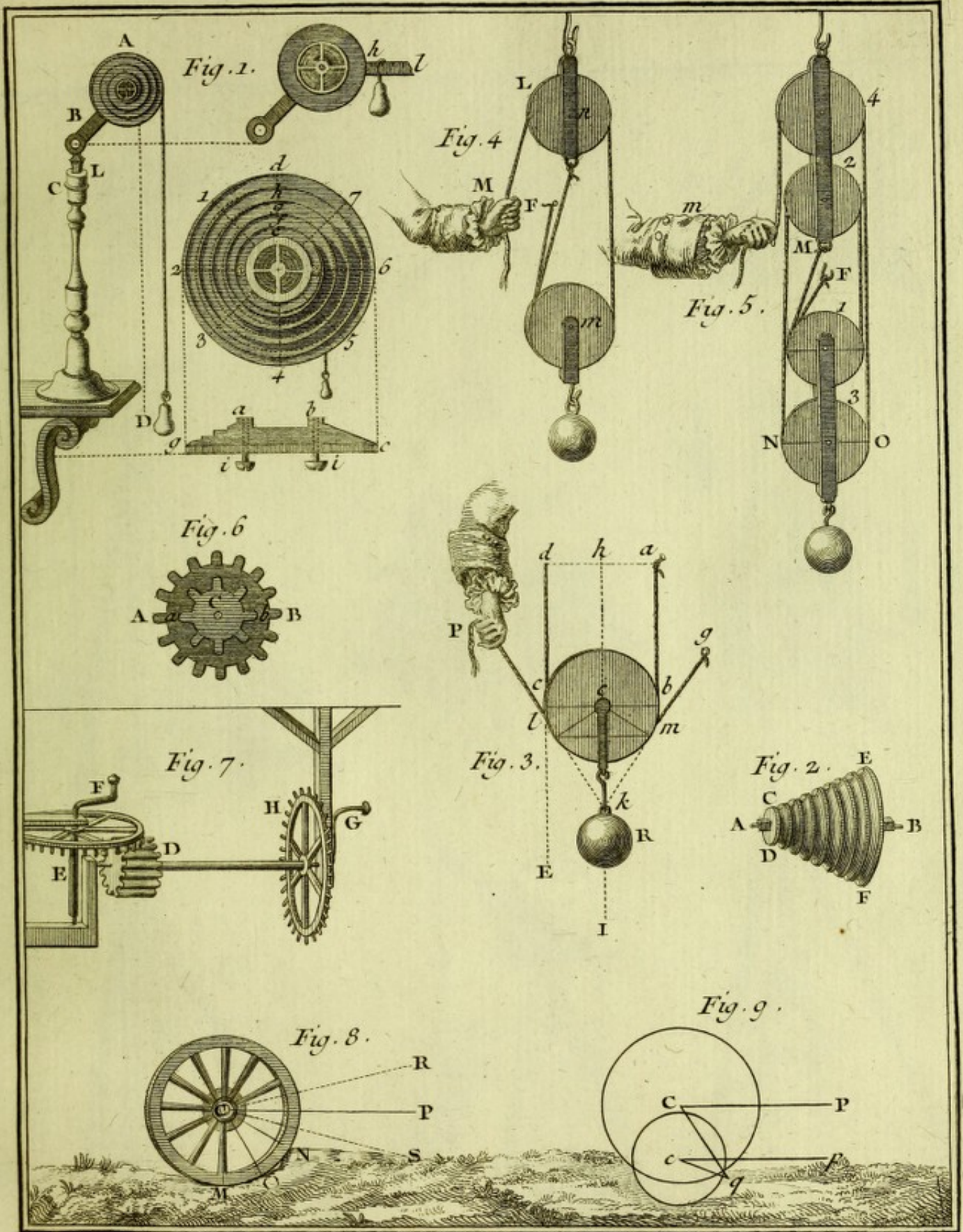


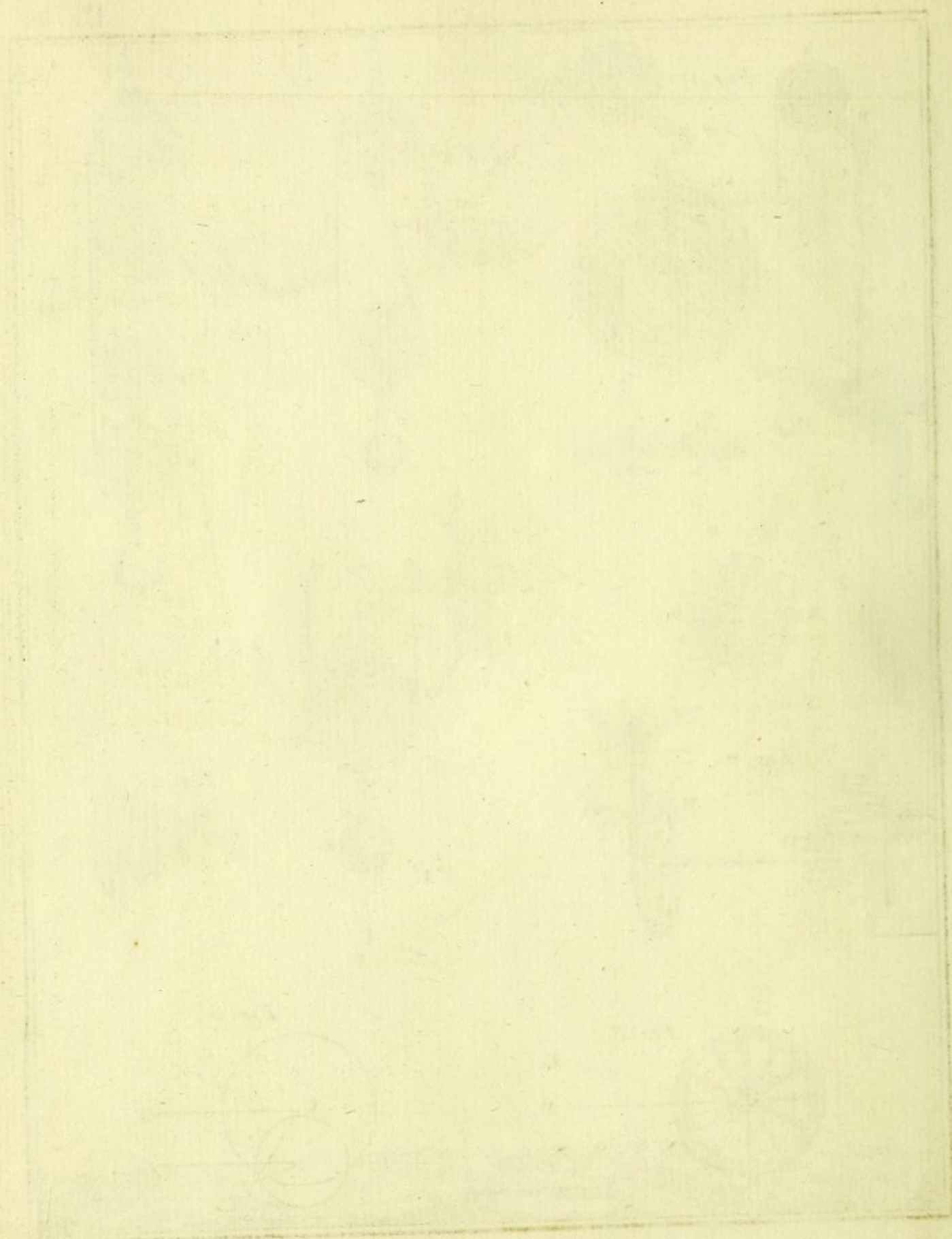
Fig. 13.



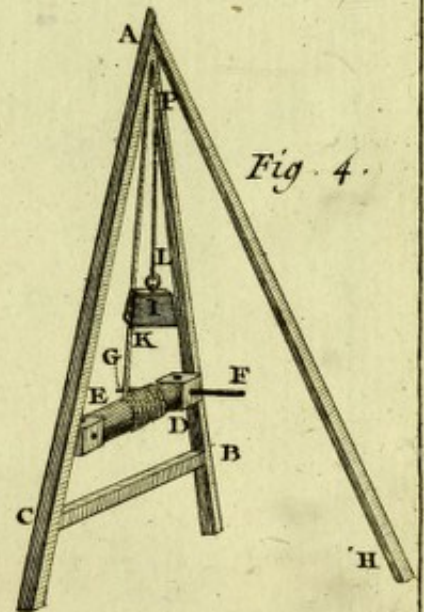
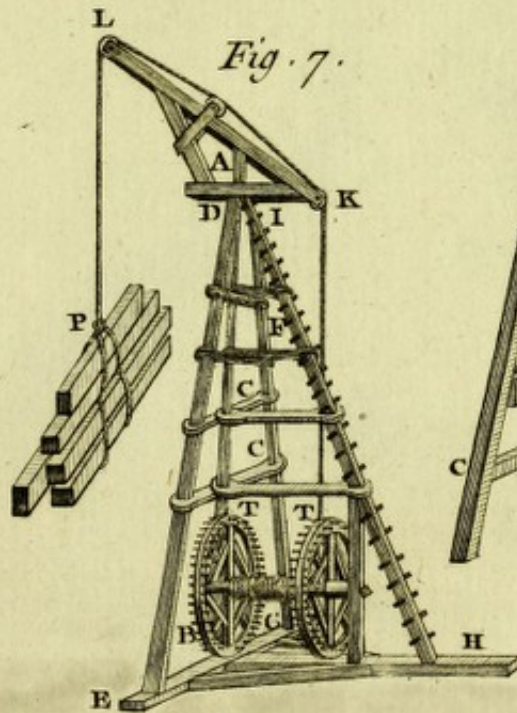
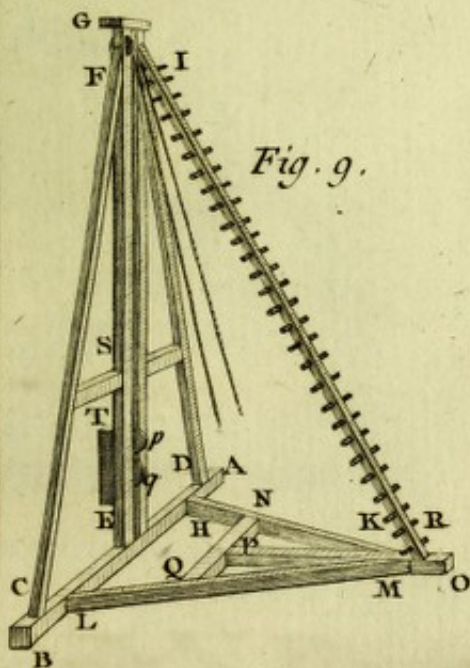
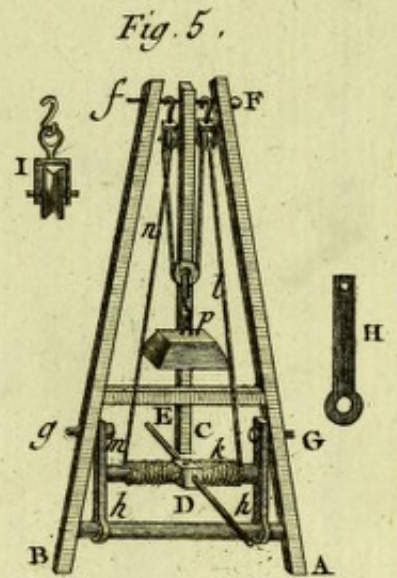
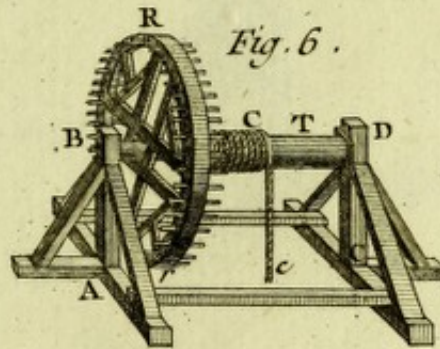
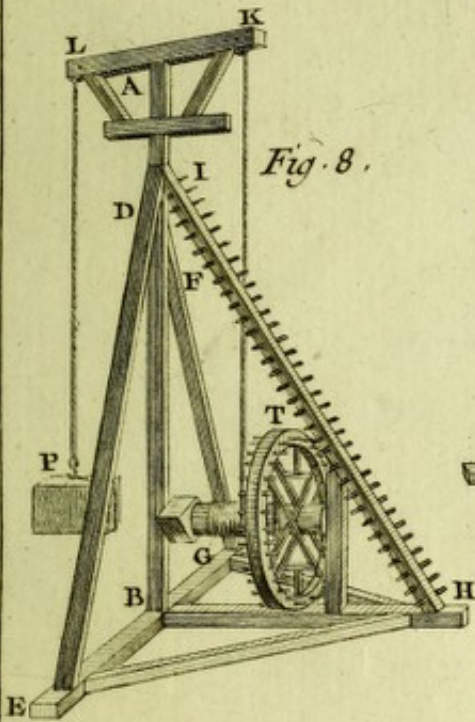
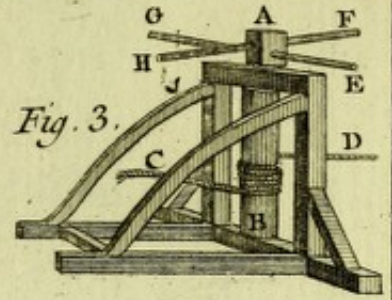
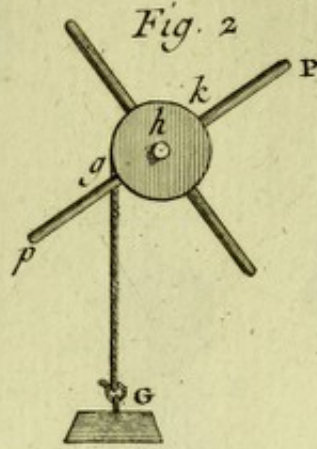
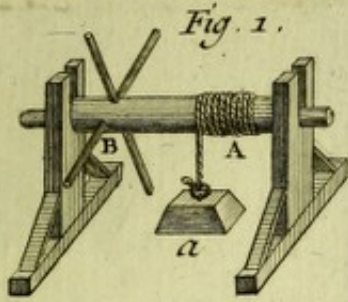


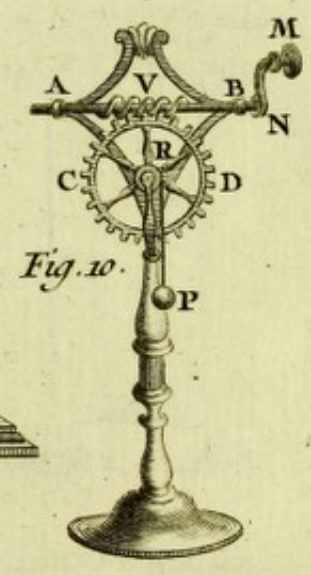
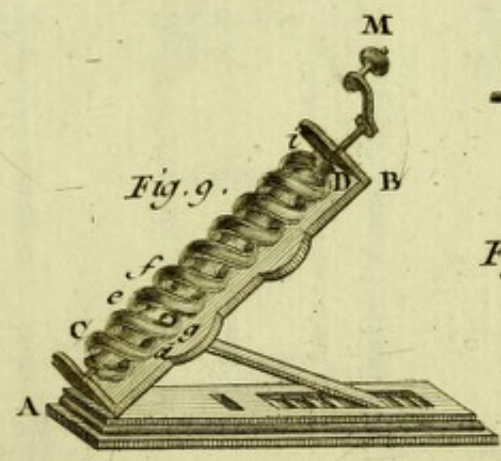
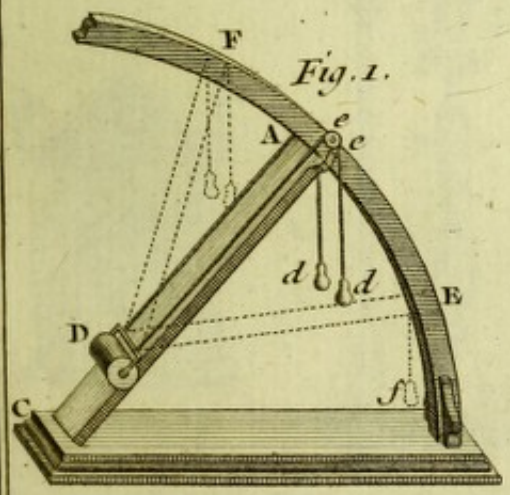
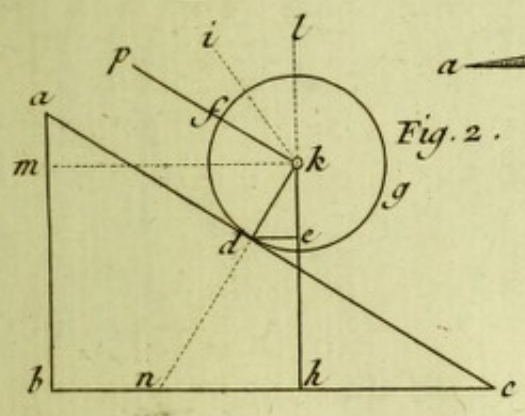
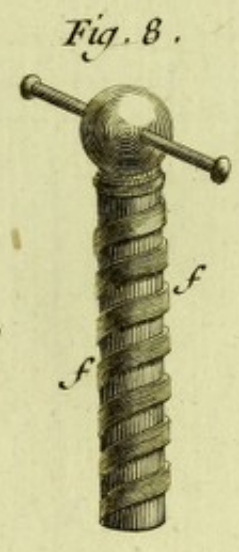
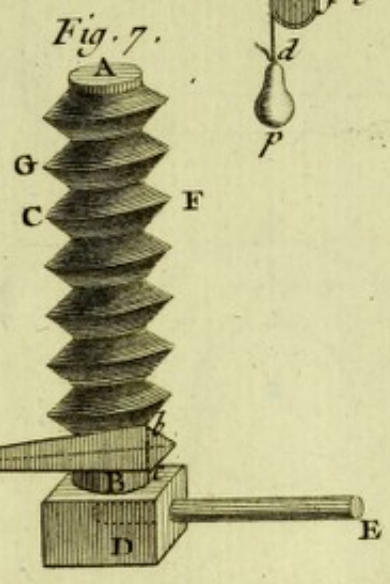
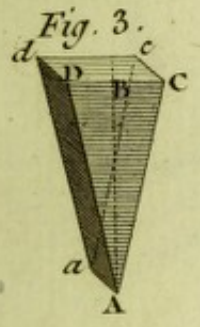
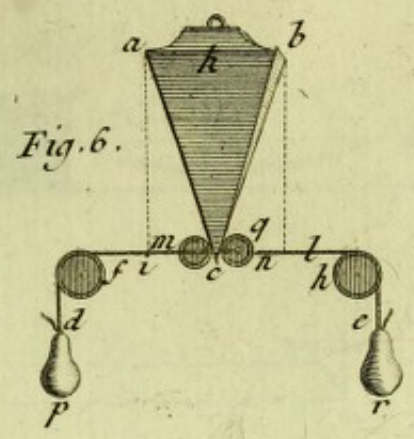
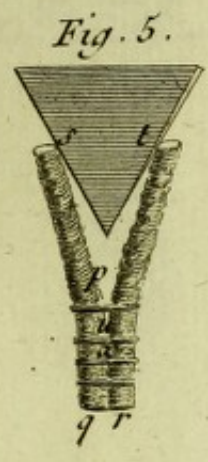
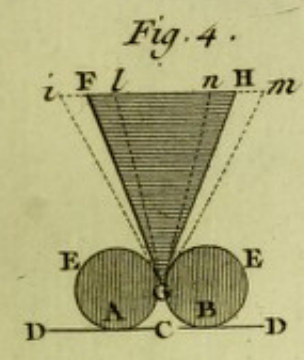
Physique.

Bernard. Diraxit.



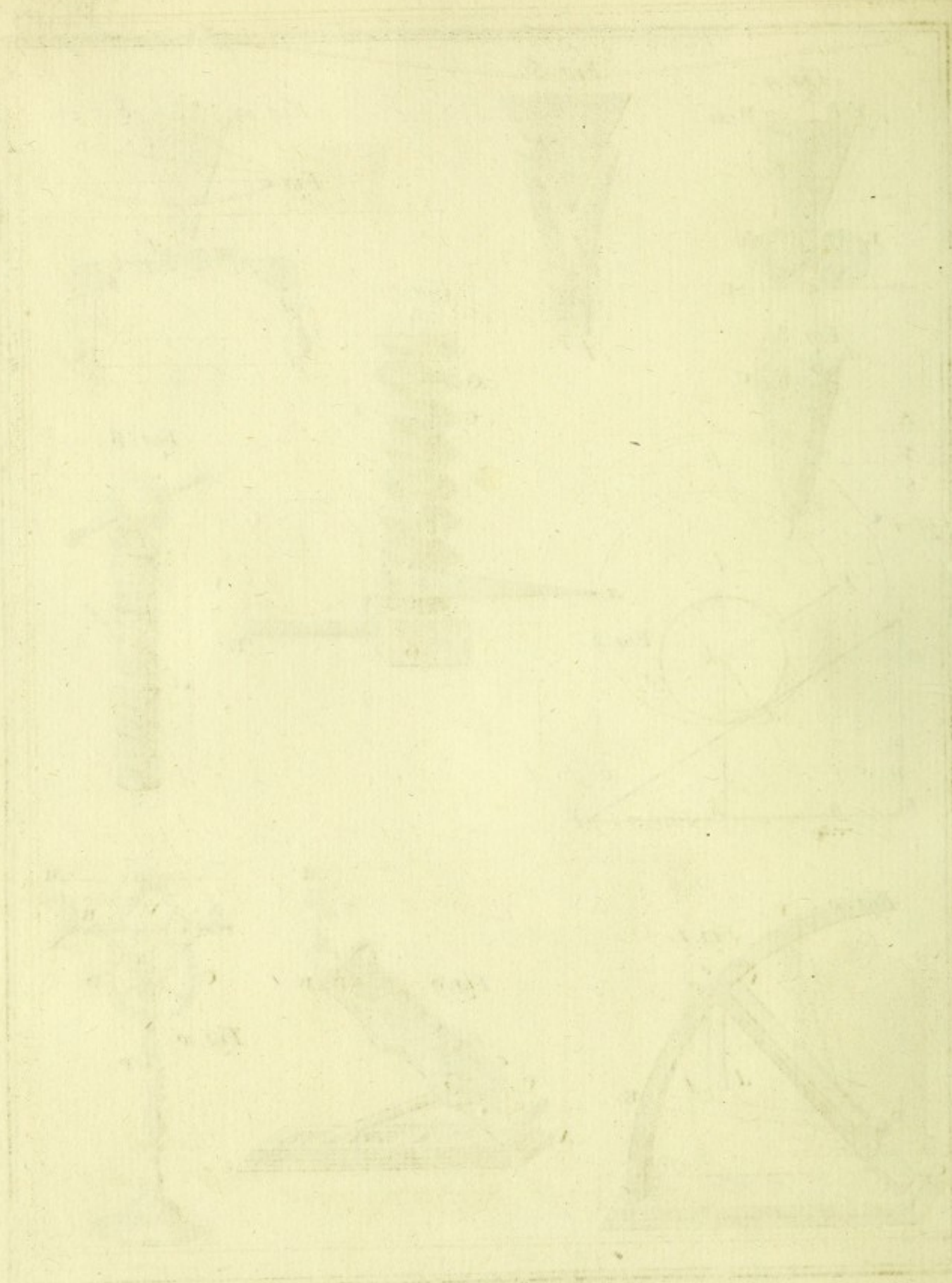
1840





Physique.

Benard Duxit.



Diagram

Fig. 8

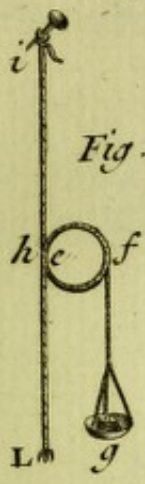


Fig. 3.

Fig. 1.

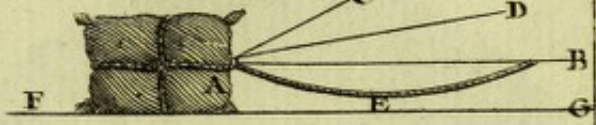


Fig. 10

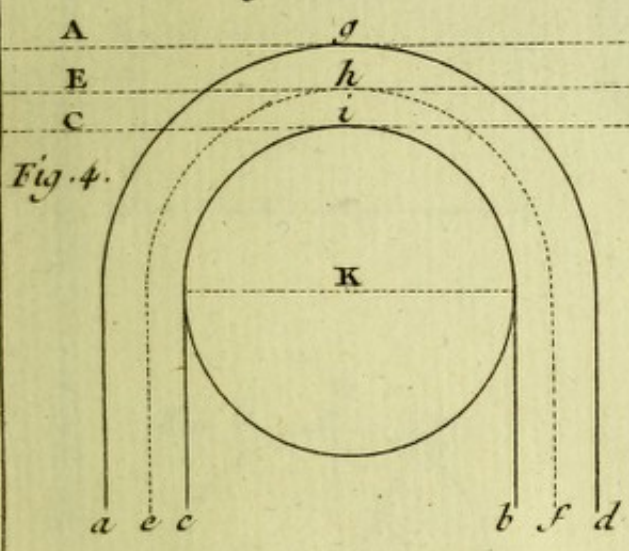
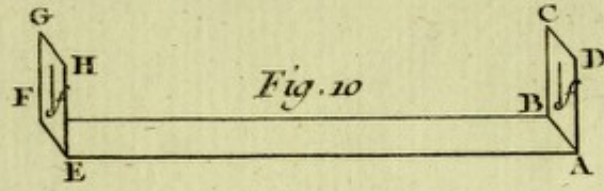


Fig. 4.

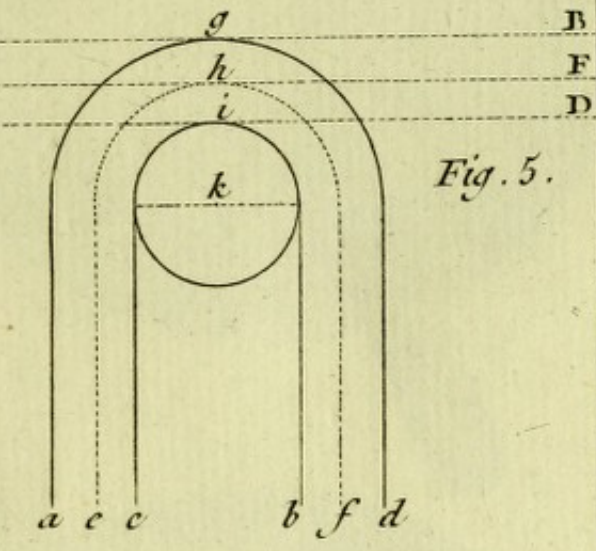


Fig. 5.



Fig. 7.

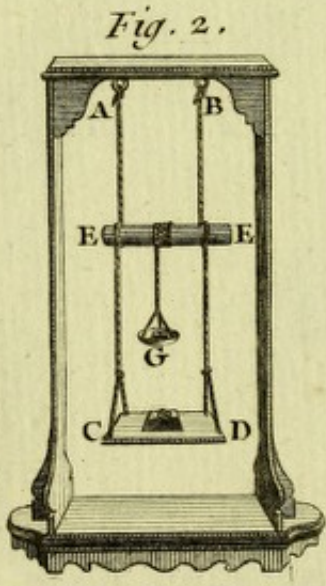


Fig. 2.

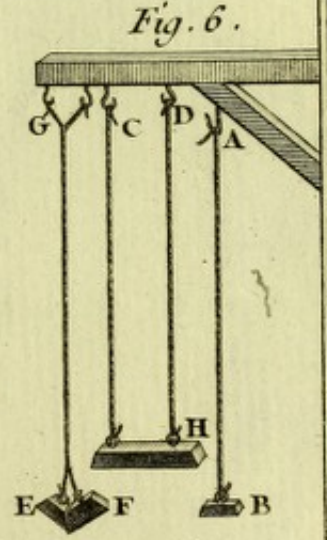


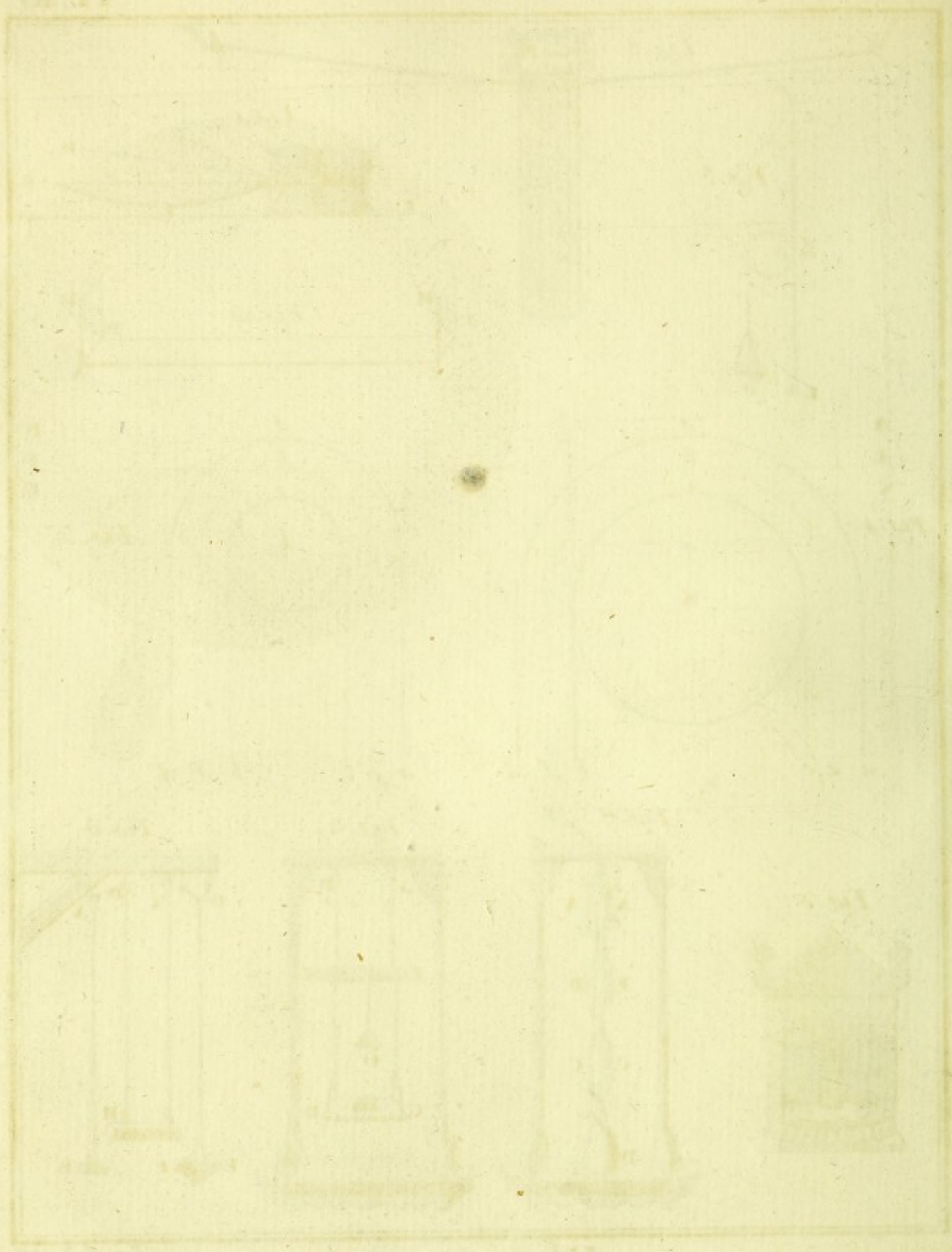
Fig. 6.



Fig. 9.

Physique.

Bonard Duxet.



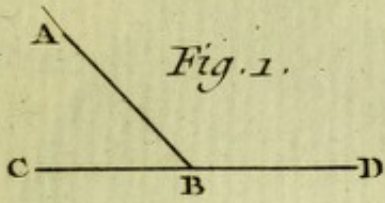


Fig. 1.

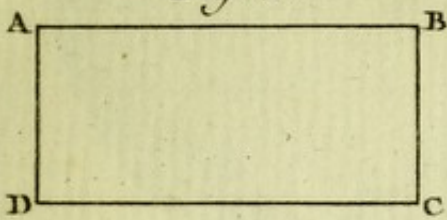


Fig. 2.

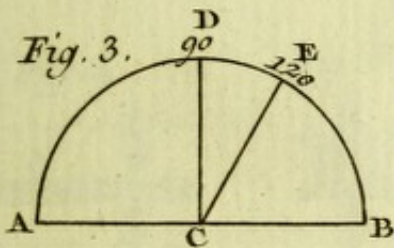


Fig. 3.

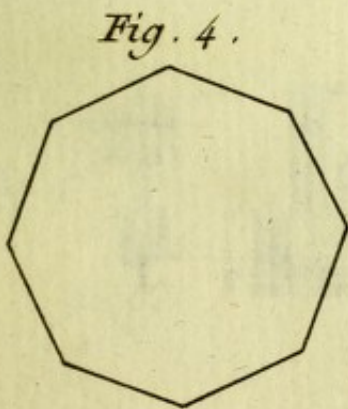


Fig. 4.

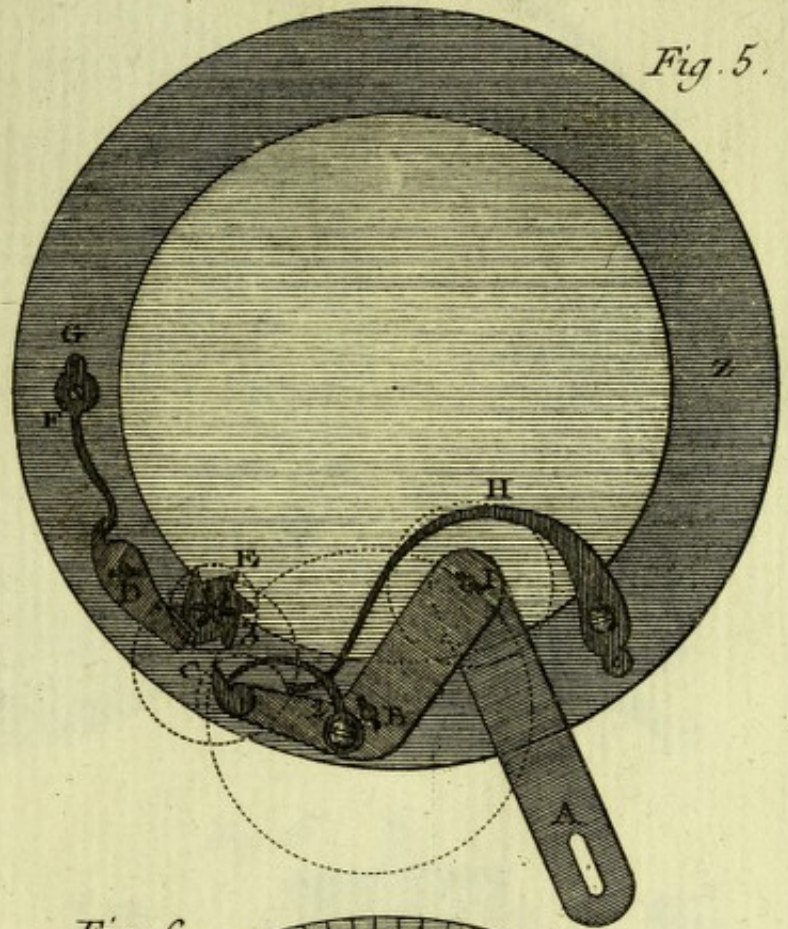


Fig. 5.

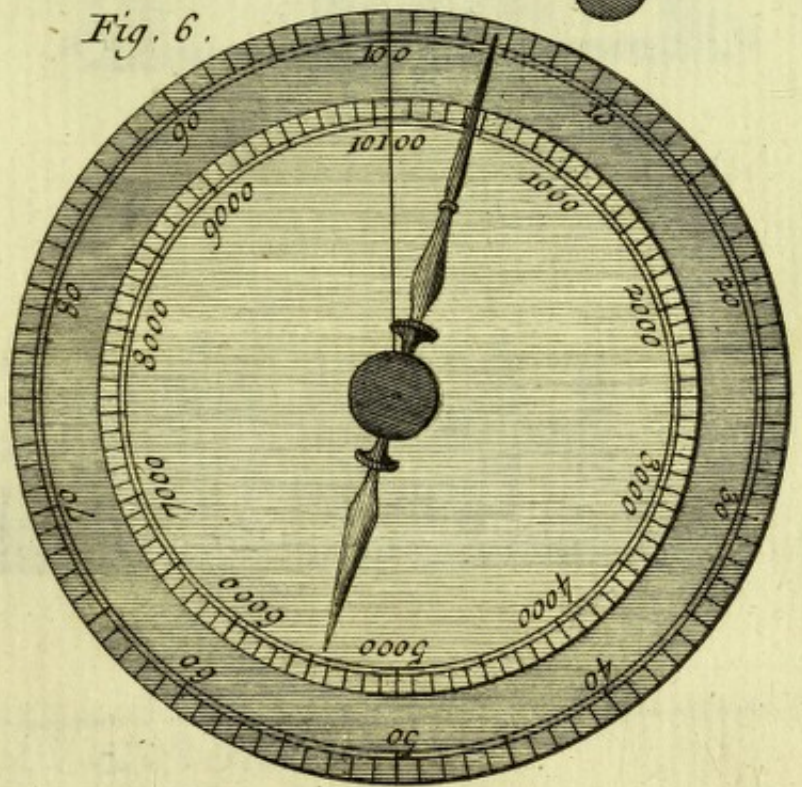


Fig. 6.

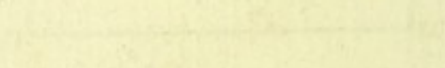
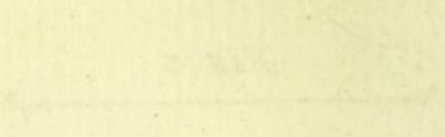


PLATE IV

Fig. 1.

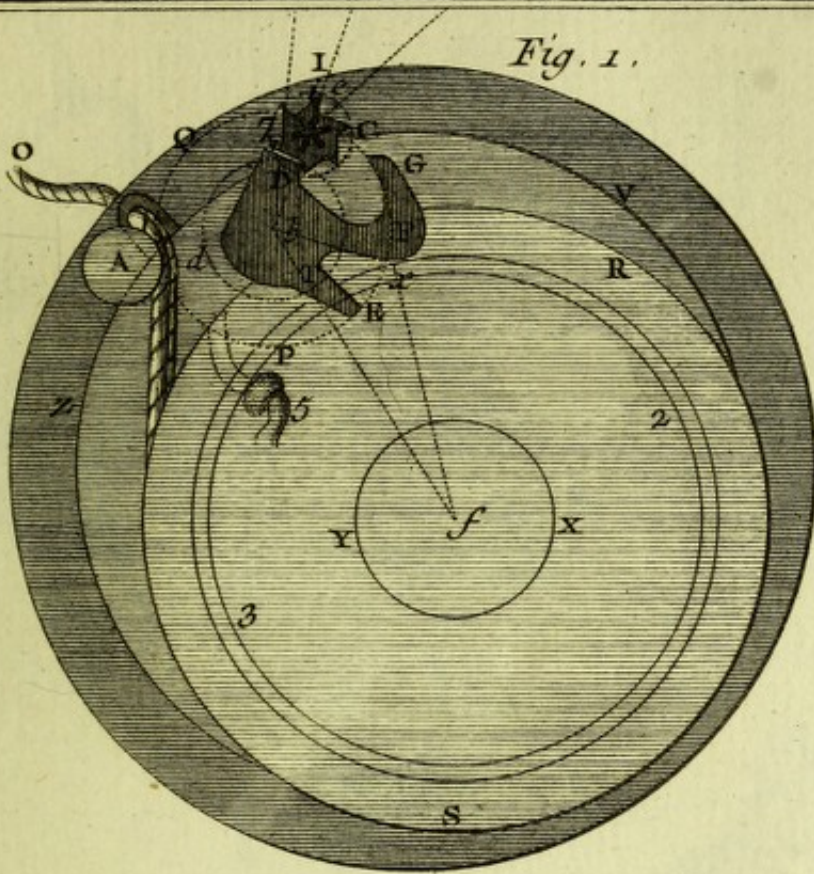


Fig. 2.



Fig. 3.

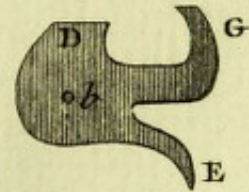


Fig. 4.

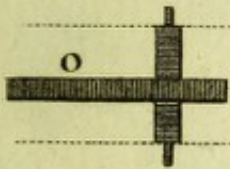


Fig. 5.

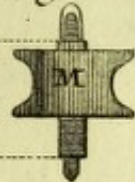


Fig. 6.

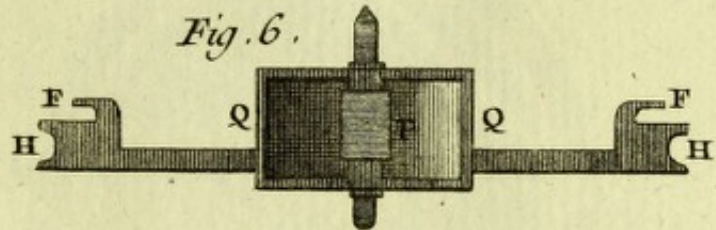


Fig. 8.

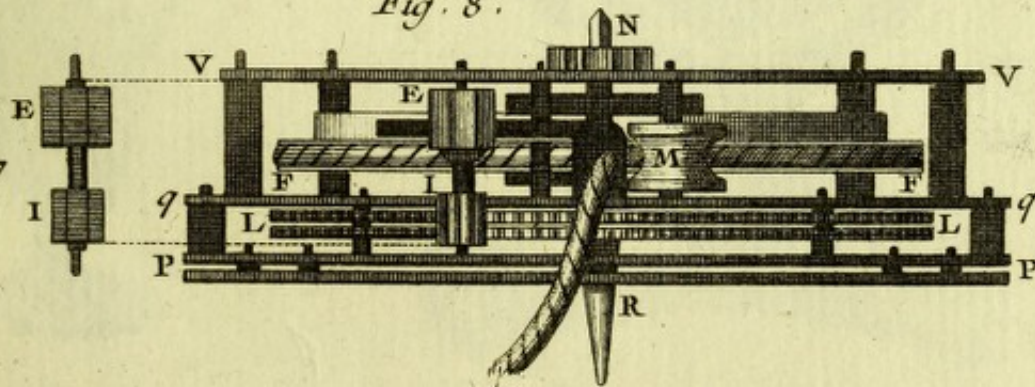
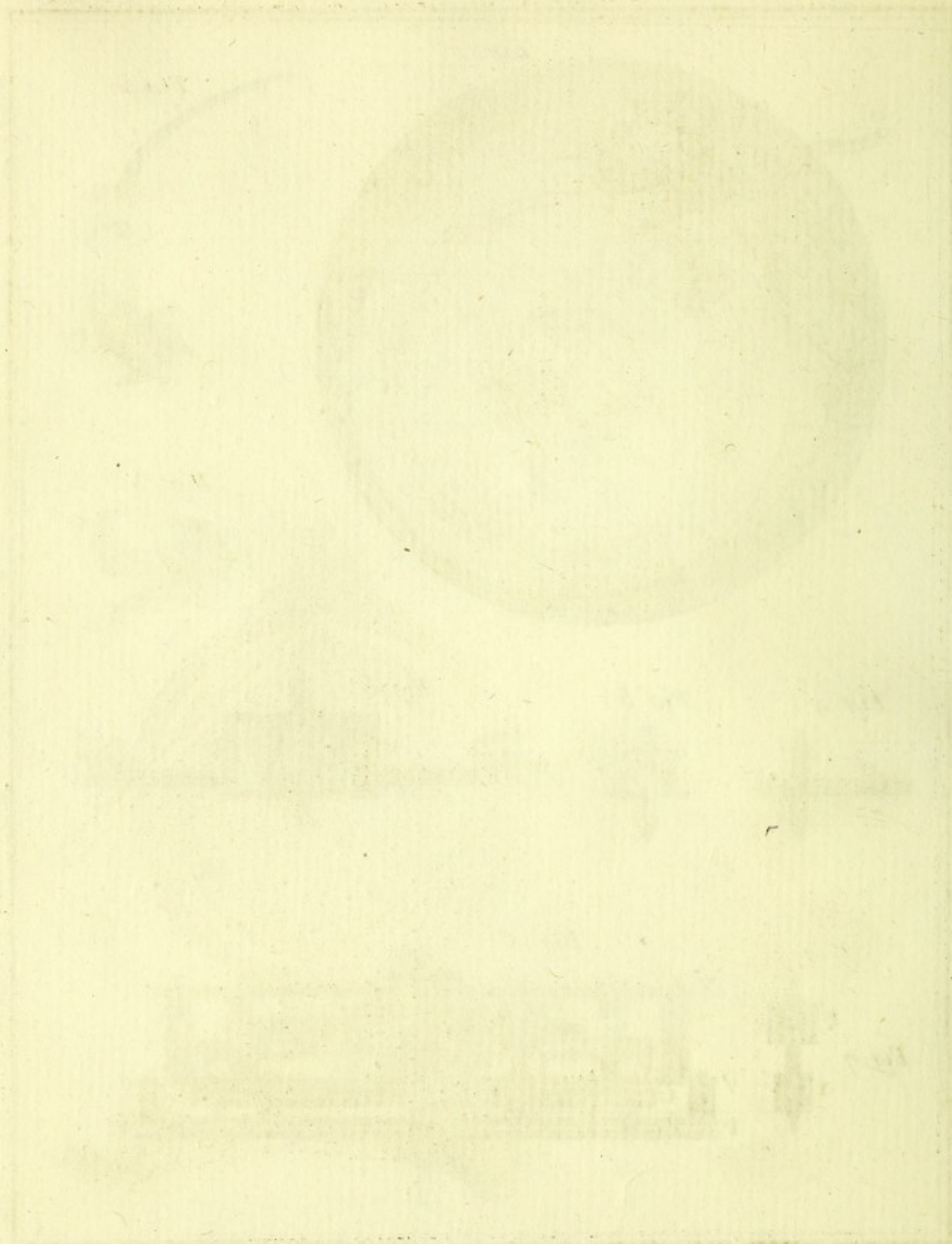
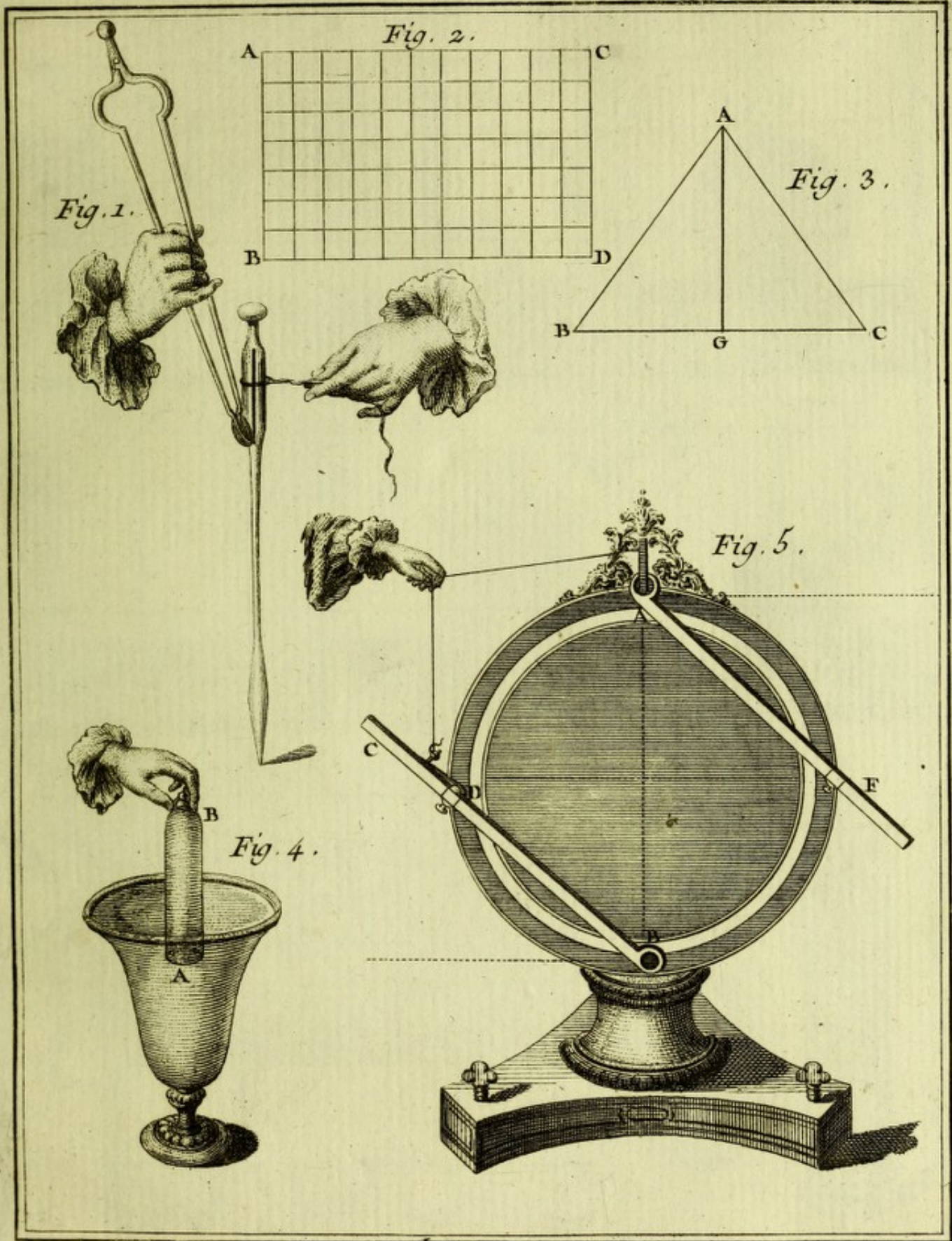


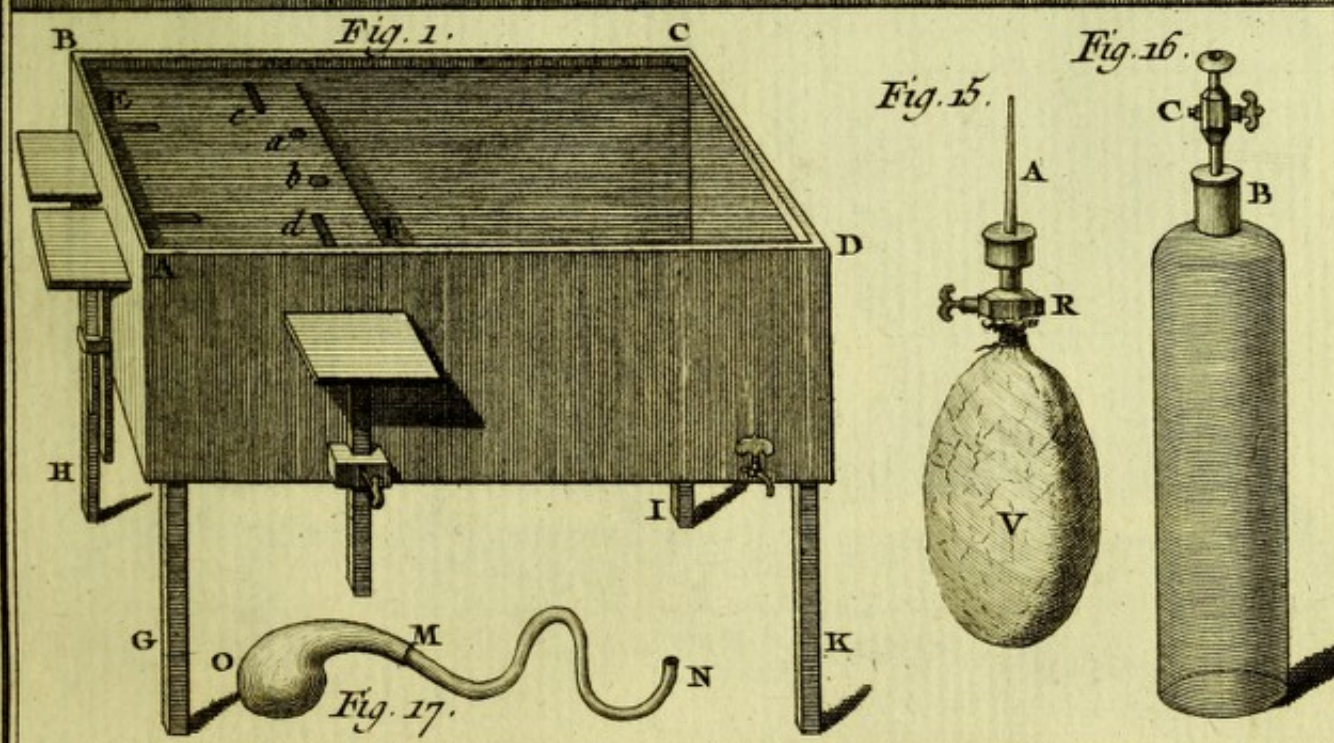
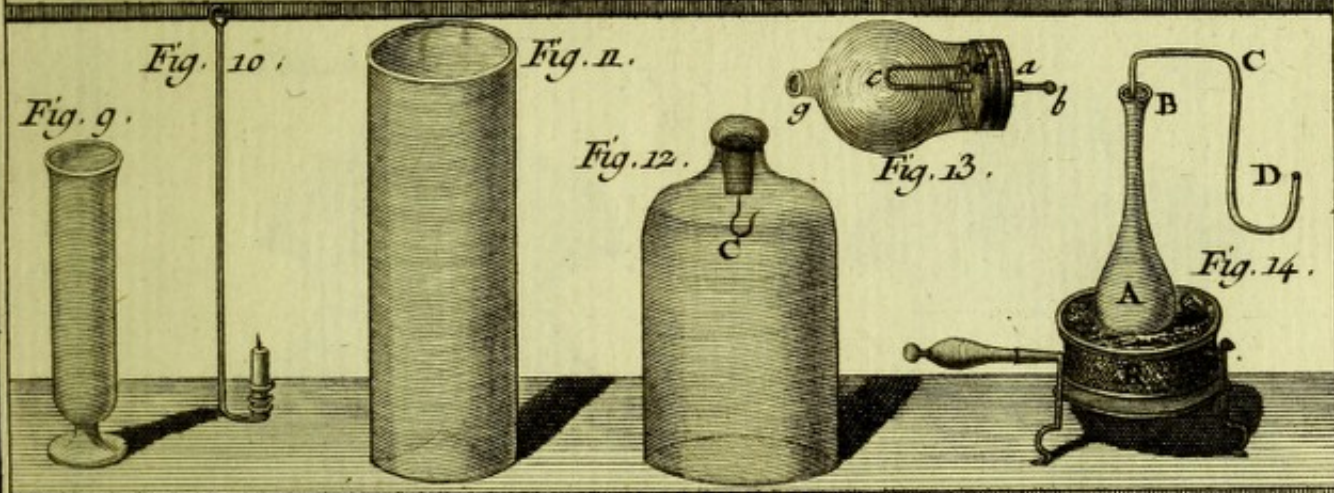
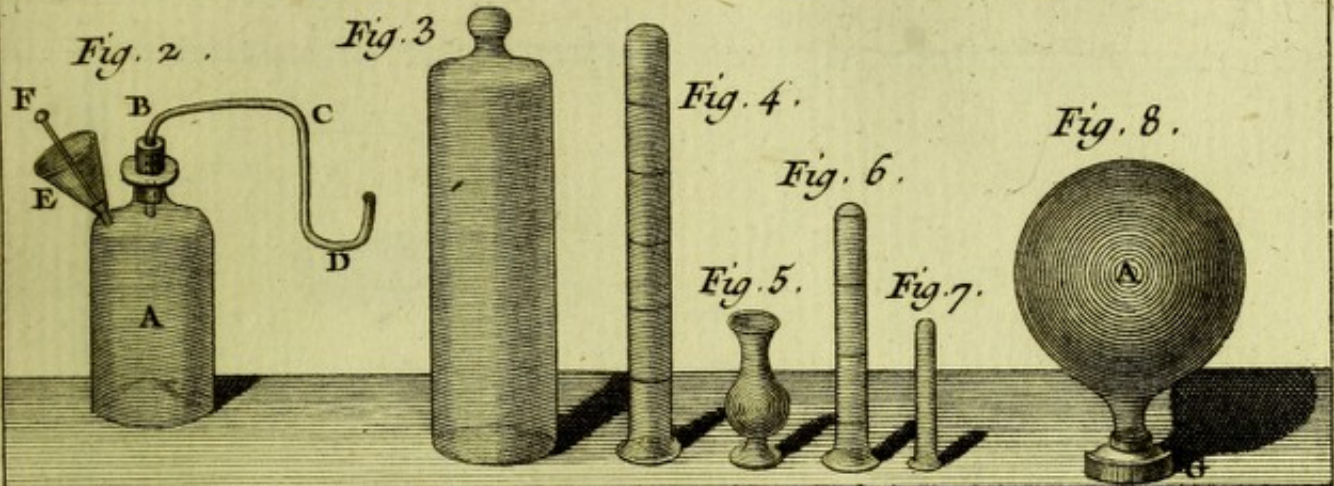
Fig. 7.







Physique.



Kossier Del.

Physique.

Benard Duxxit.

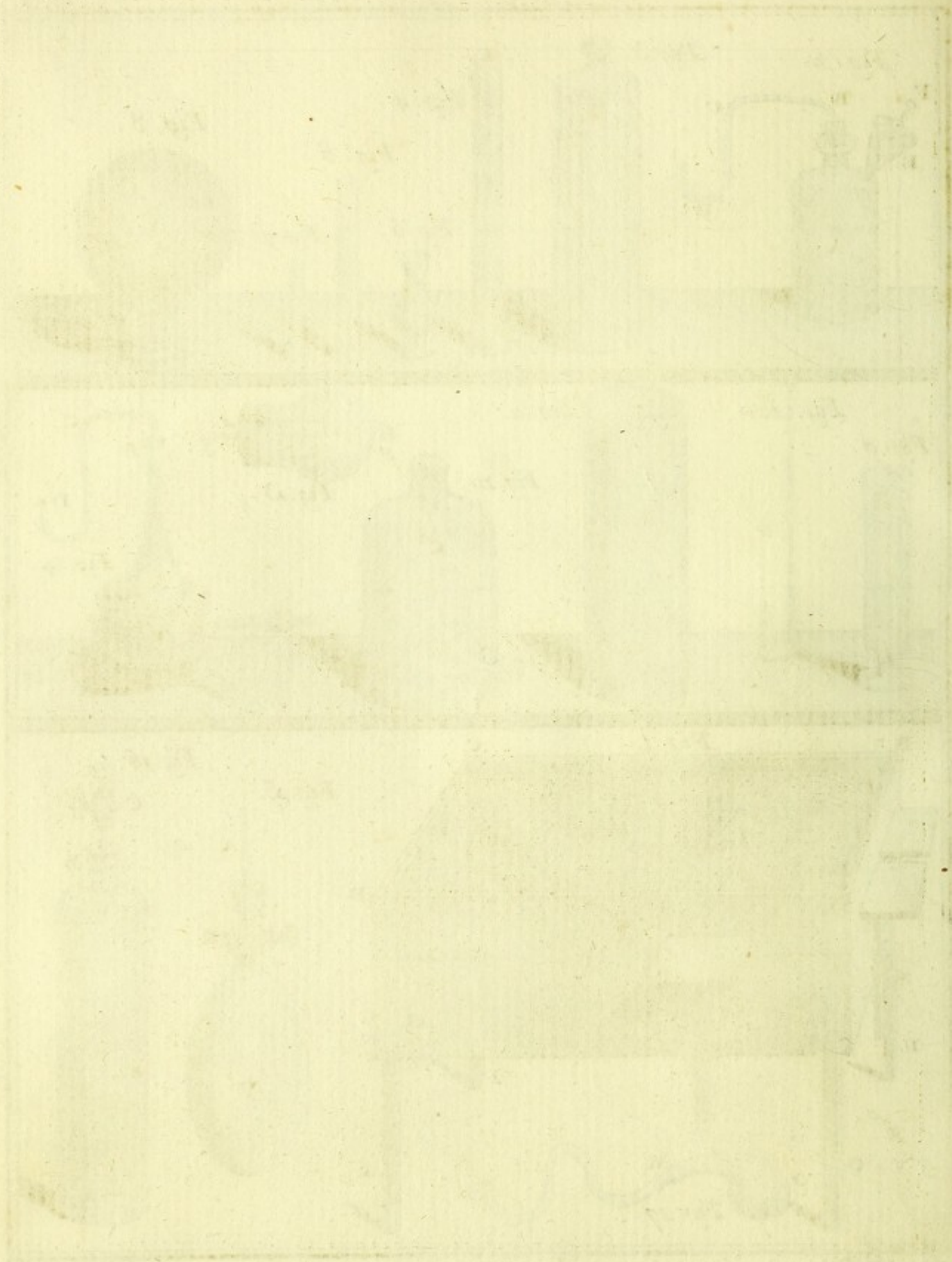
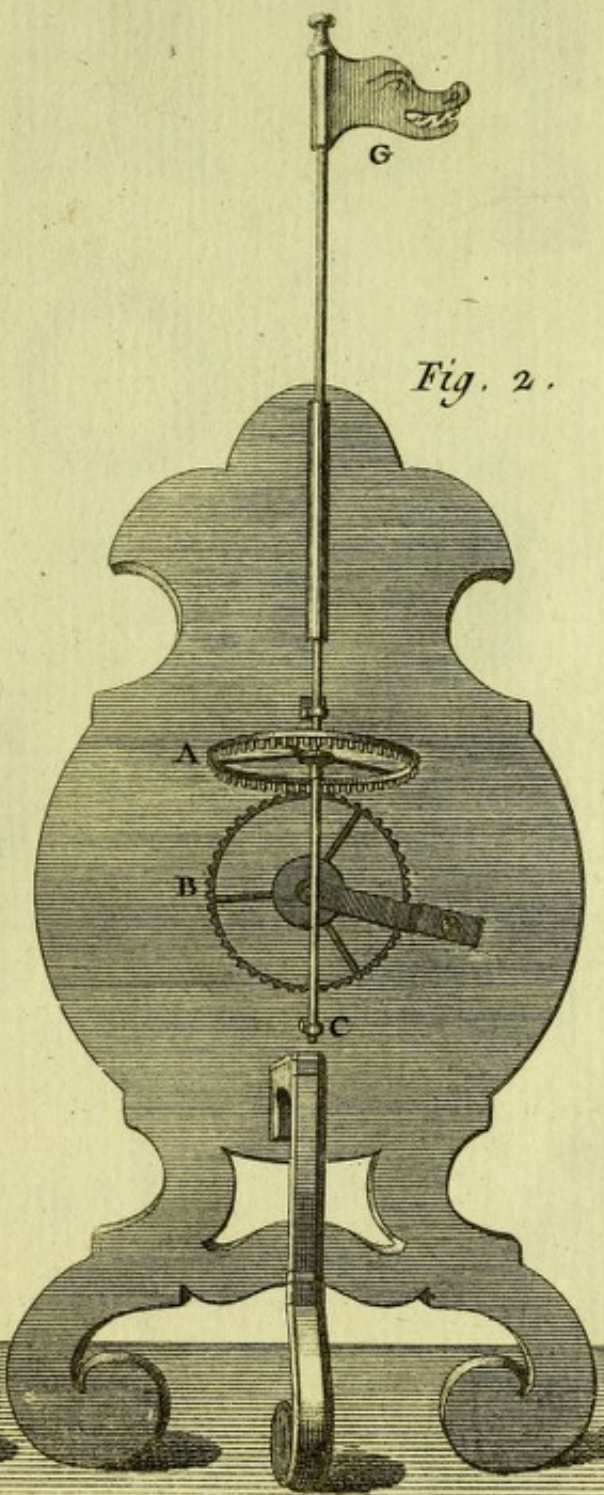


Fig. 1.

Fig. 2.



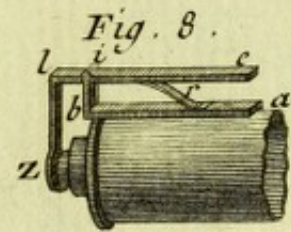
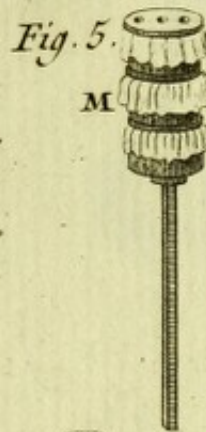
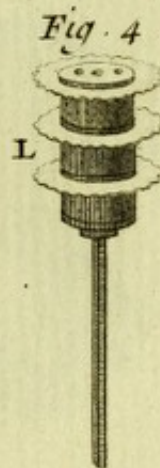
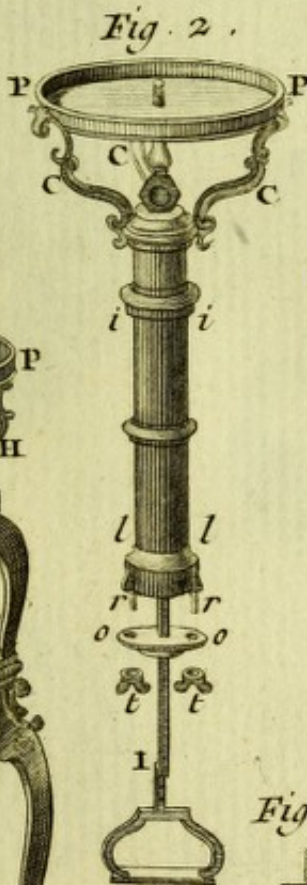
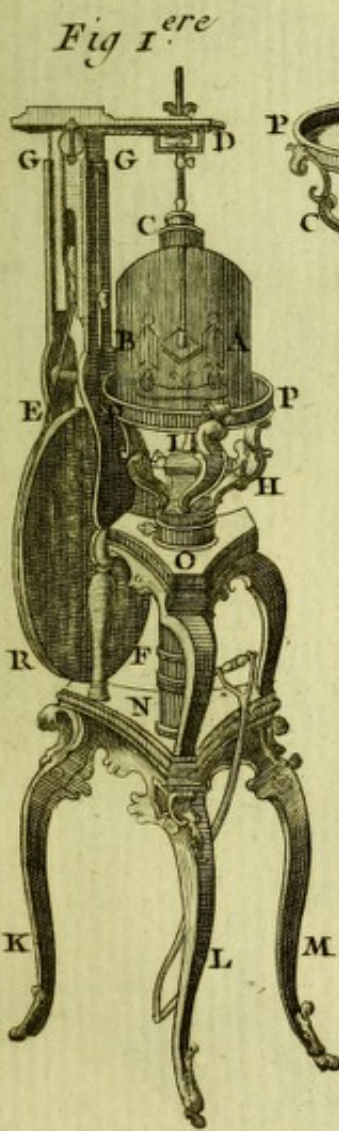
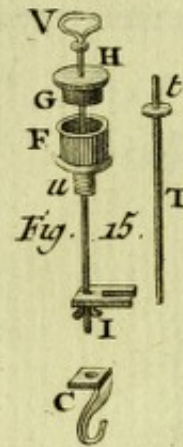
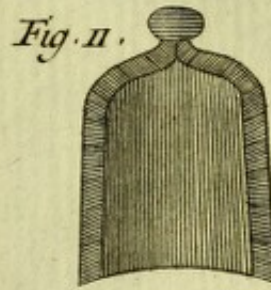
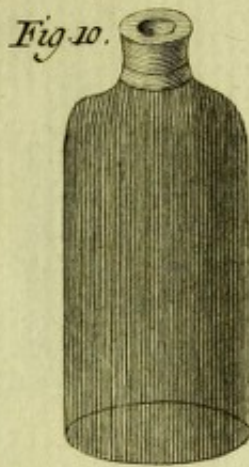


Fig. 3.



Fig. 7.

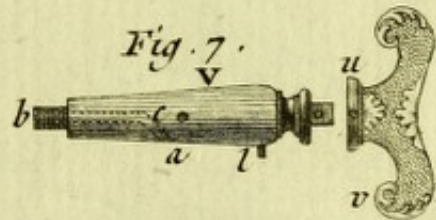


Fig. 16.

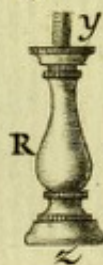
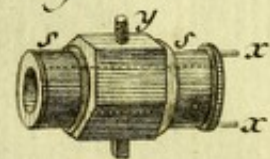
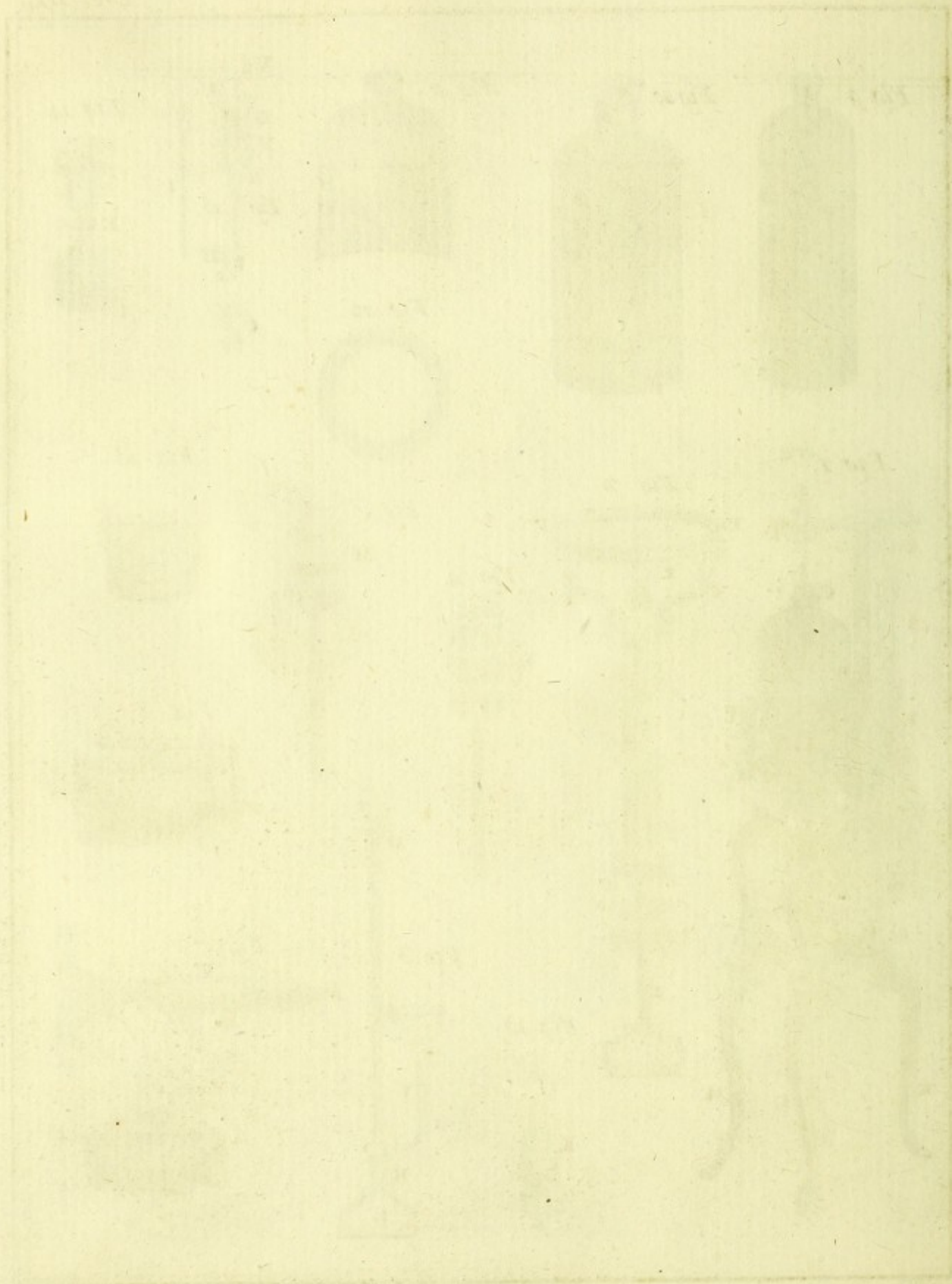


Fig. 6.





[Faint, illegible text or markings, possibly bleed-through from the reverse side of the page.]

Fig. 1.

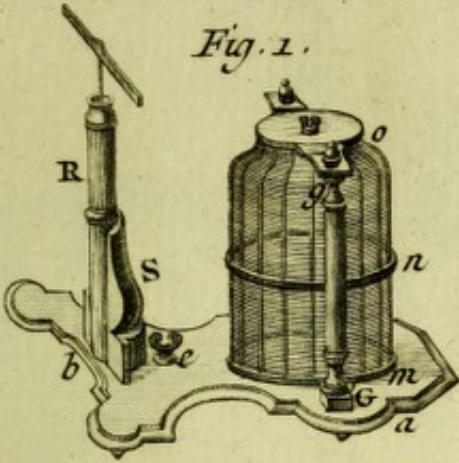


Fig. 3.



Fig. 5.

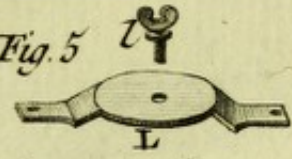


Fig. 4.

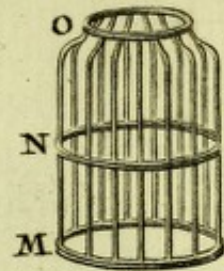


Fig. 2.

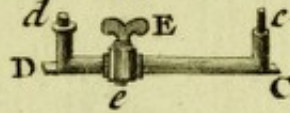


Fig. 6.

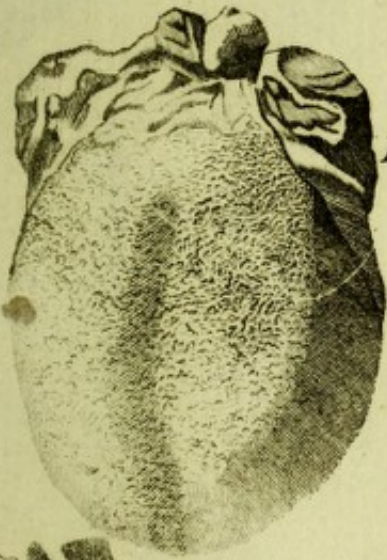


Fig. 9.

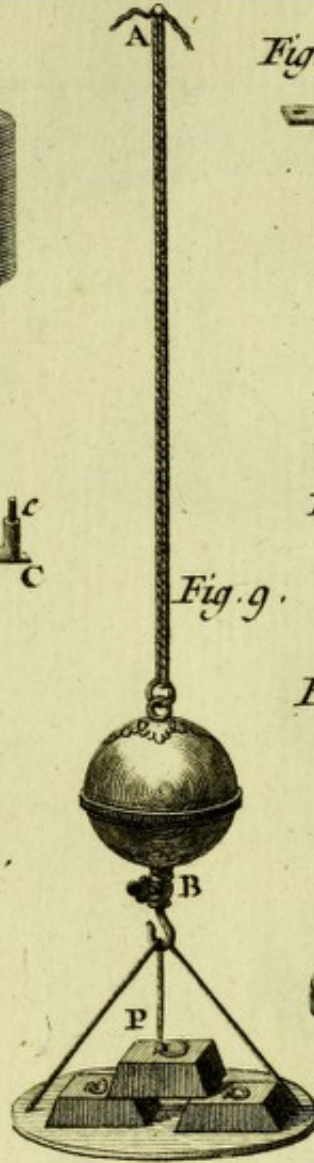


Fig. 10.



Fig. 12.

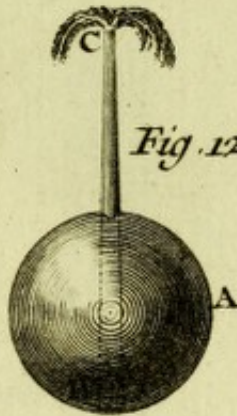


Fig. 7.

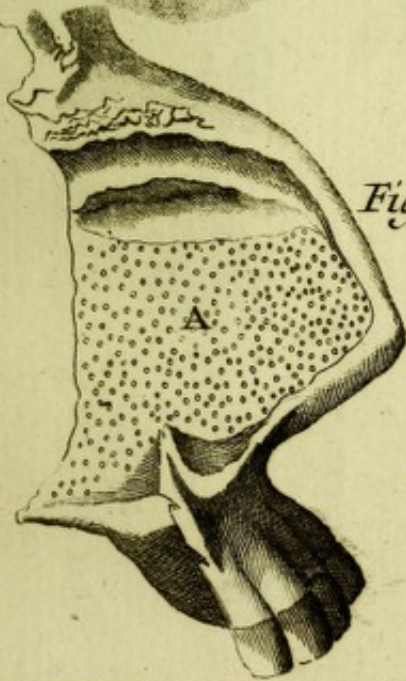


Fig. 11.

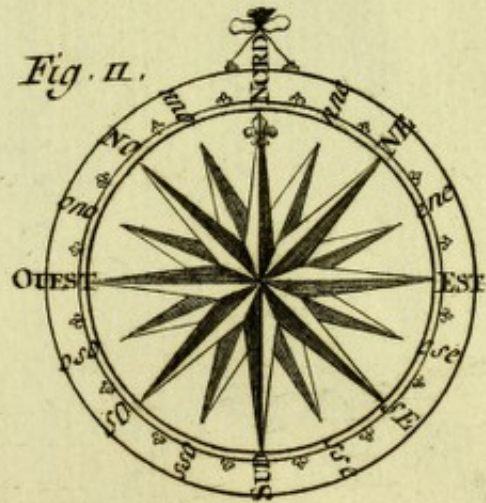
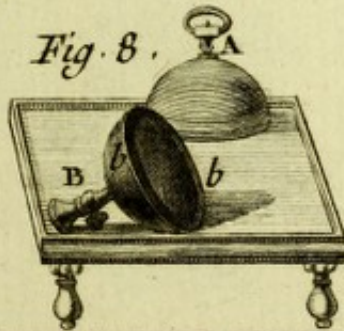
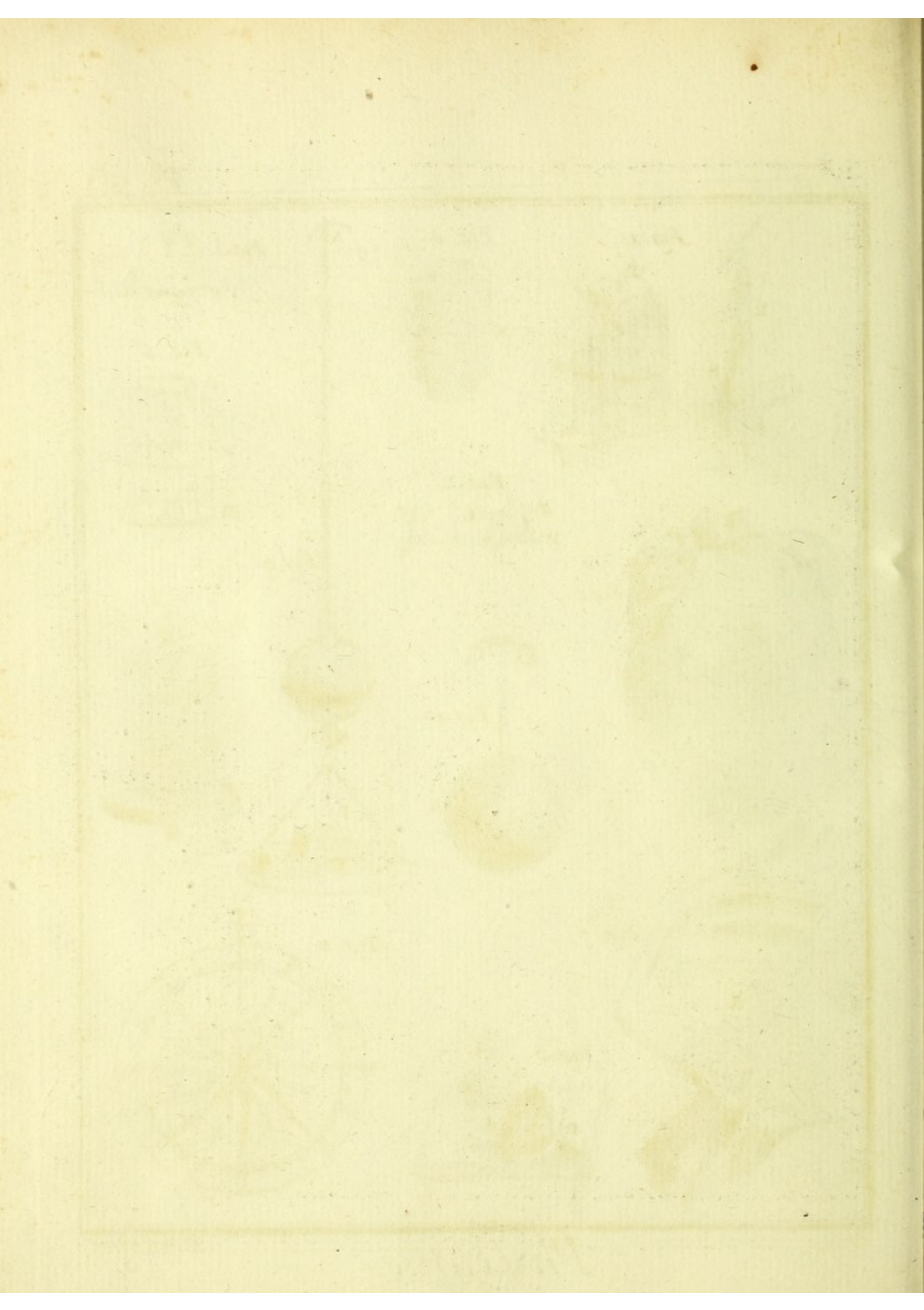
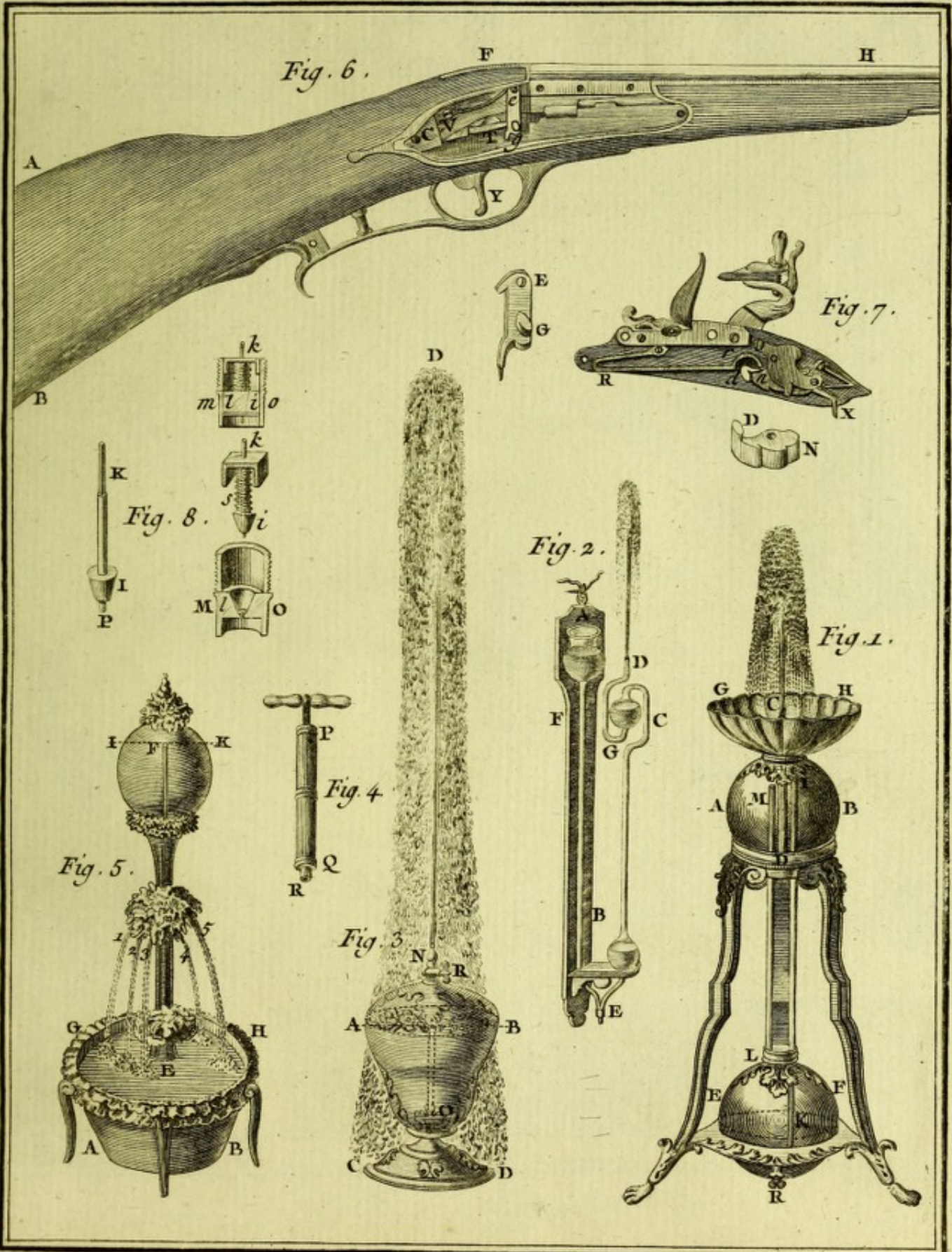


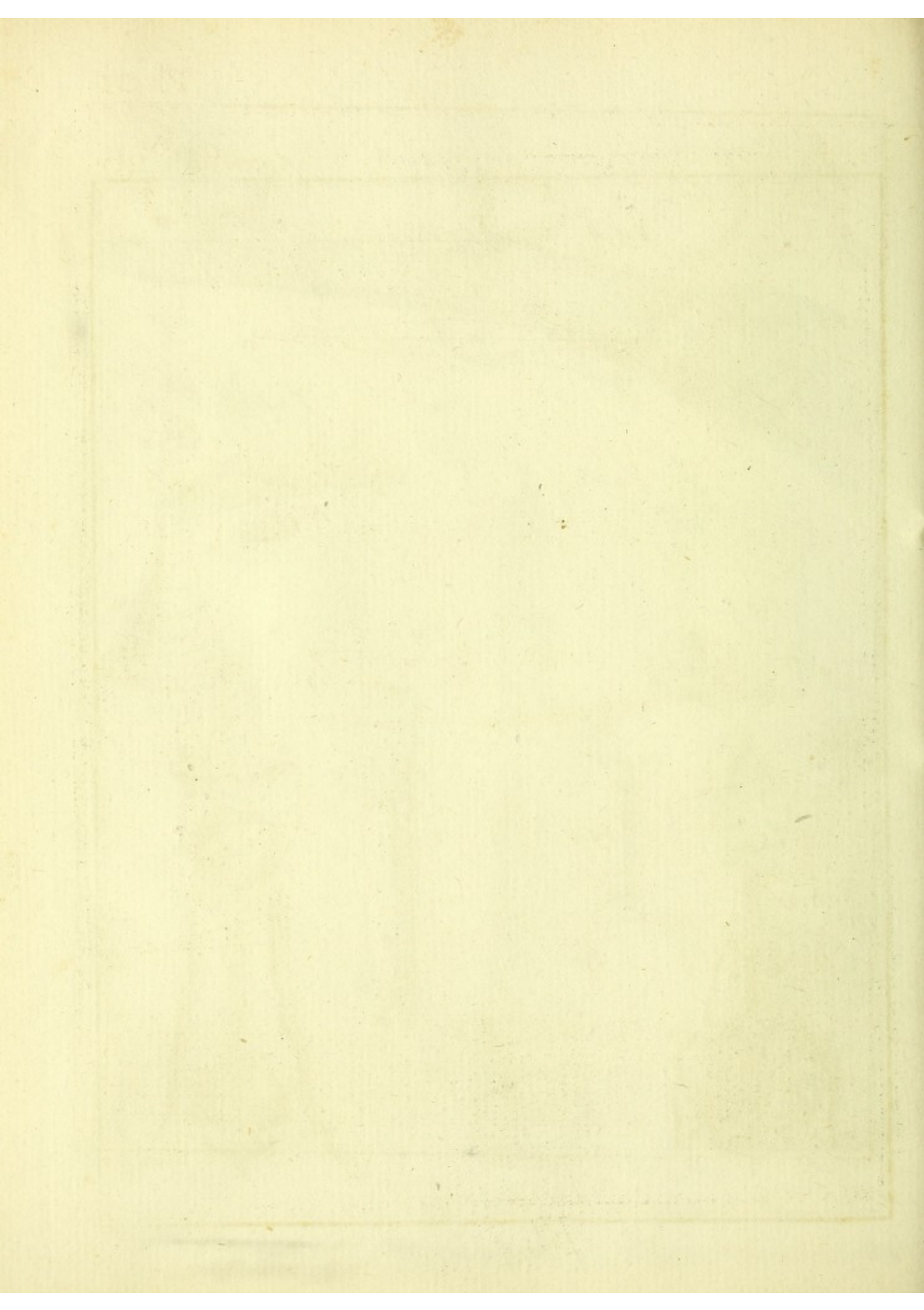
Fig. 8.

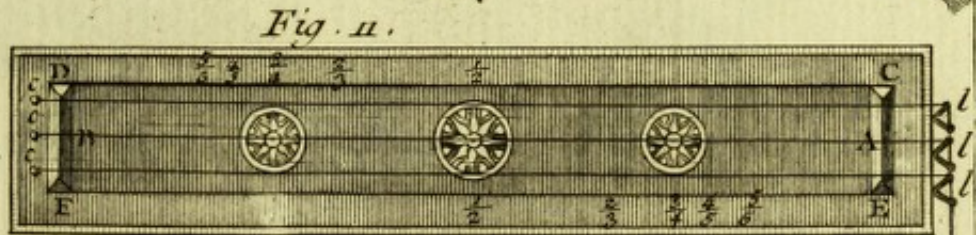
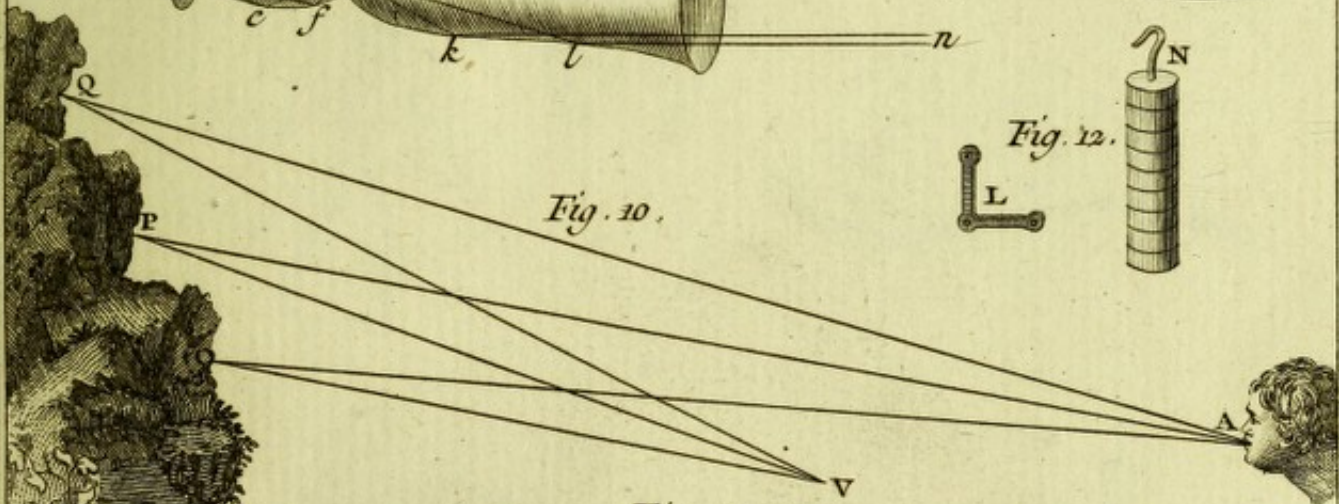
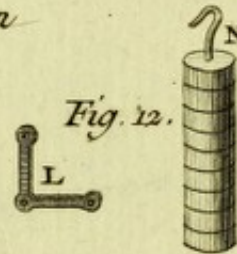
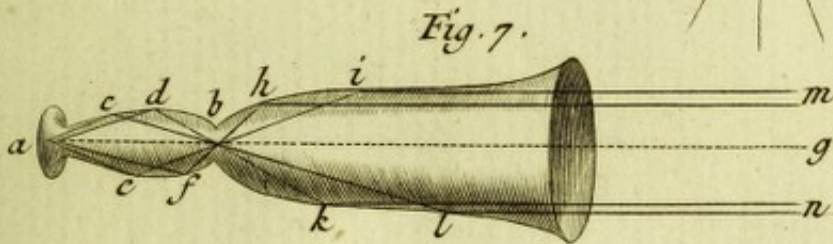
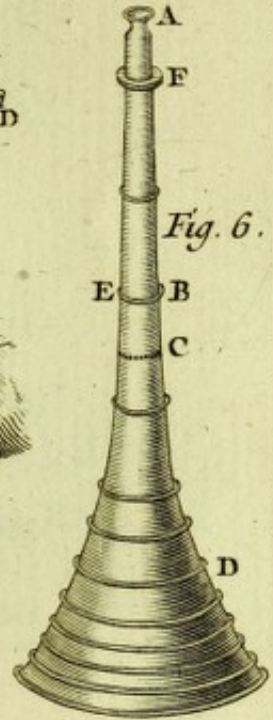
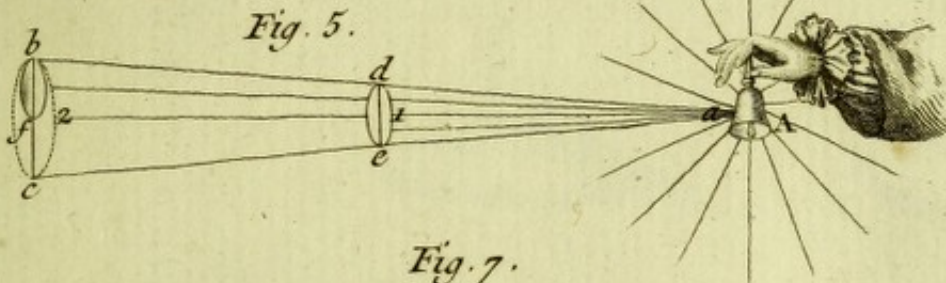
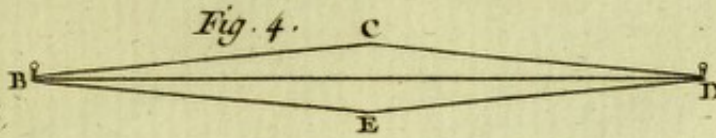
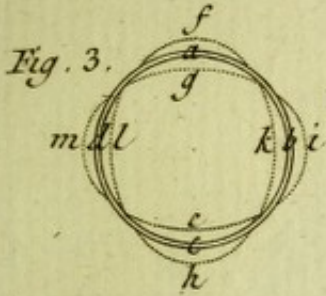
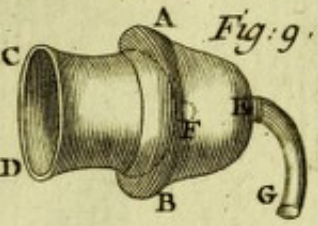
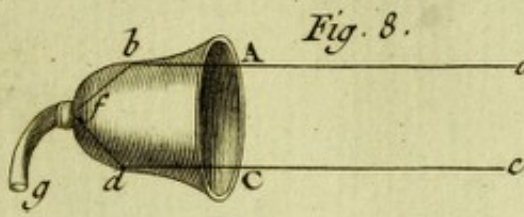
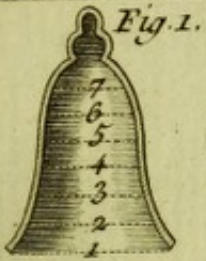


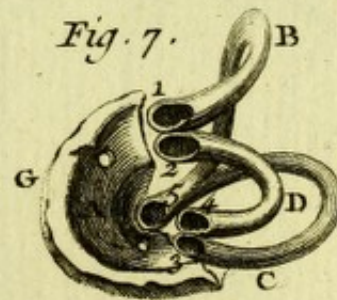
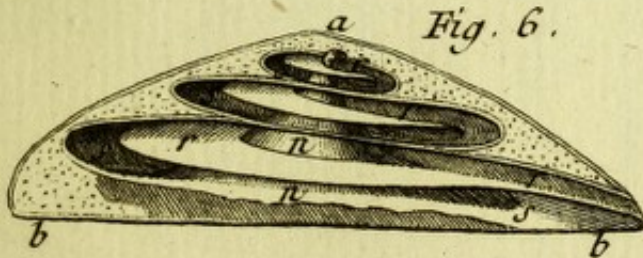
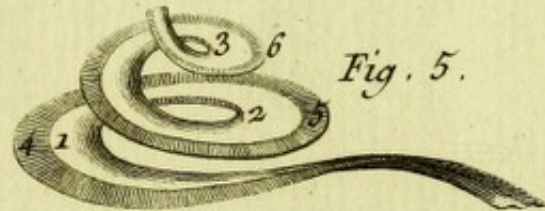
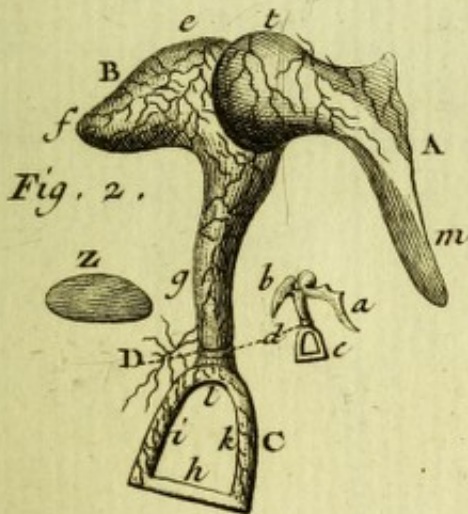
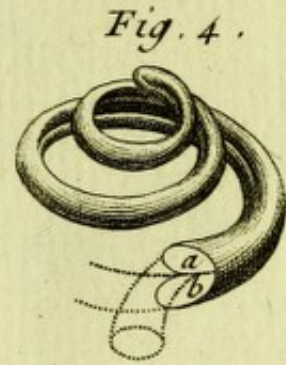
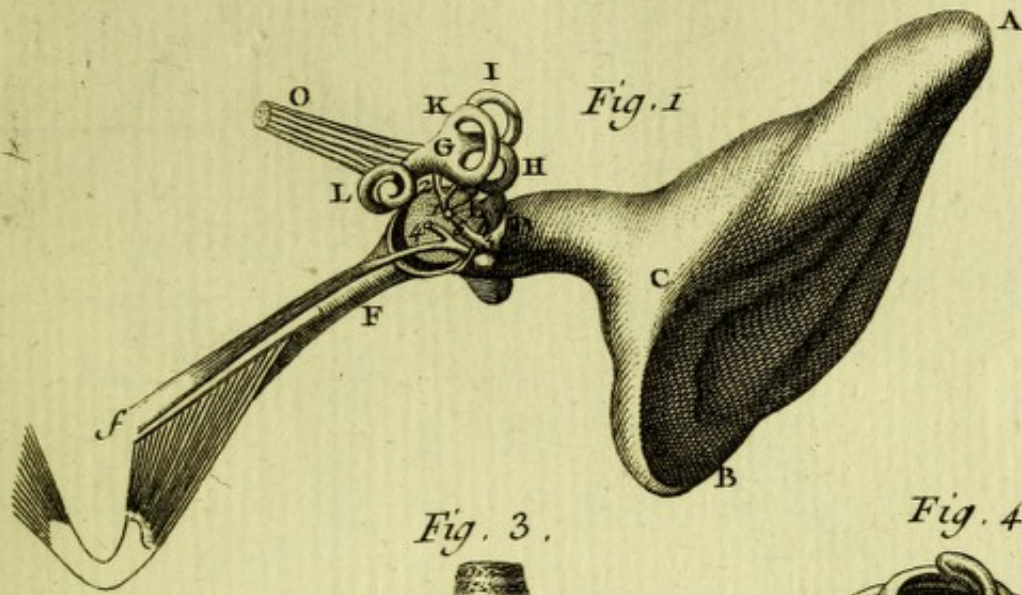
Bernard Drexel.



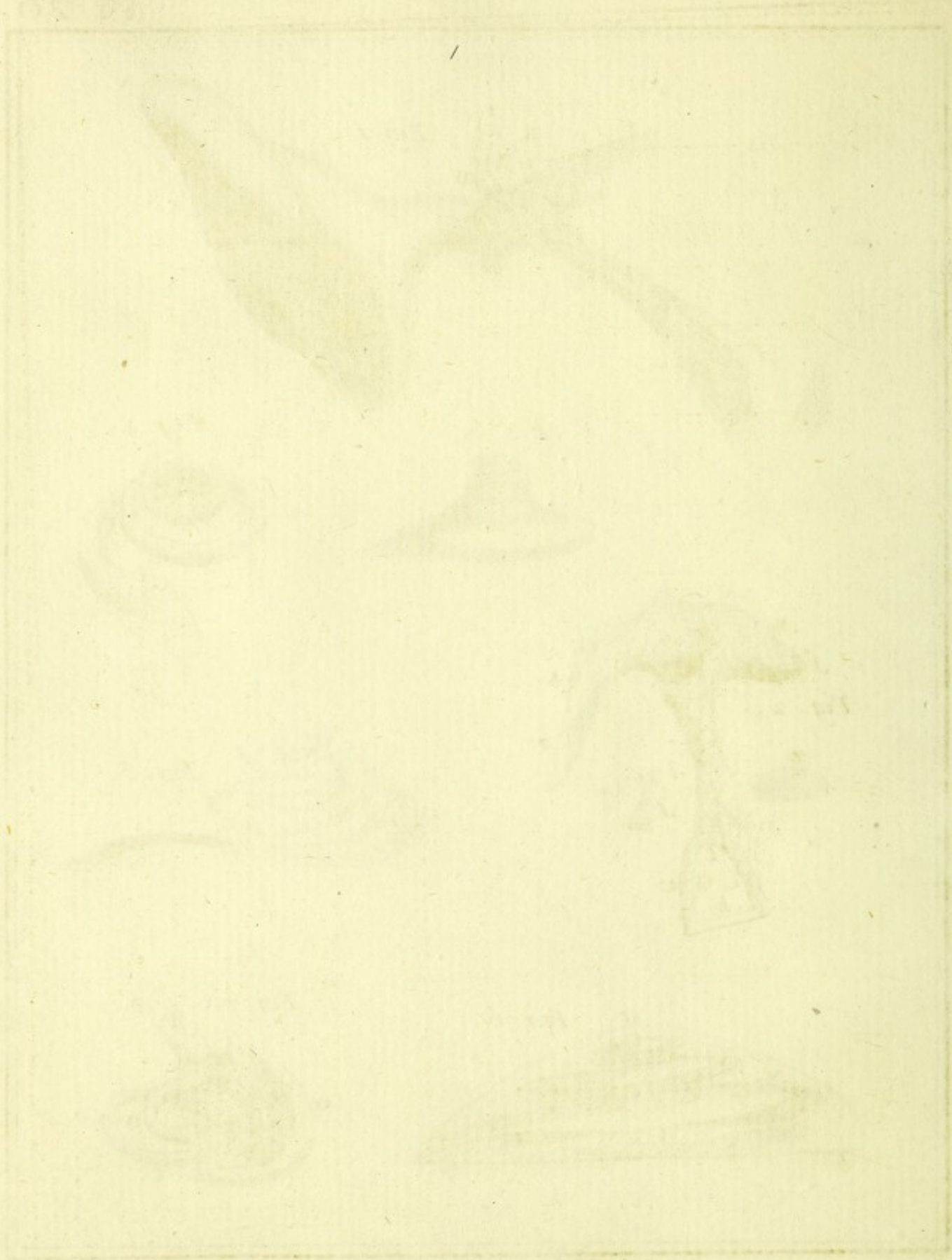


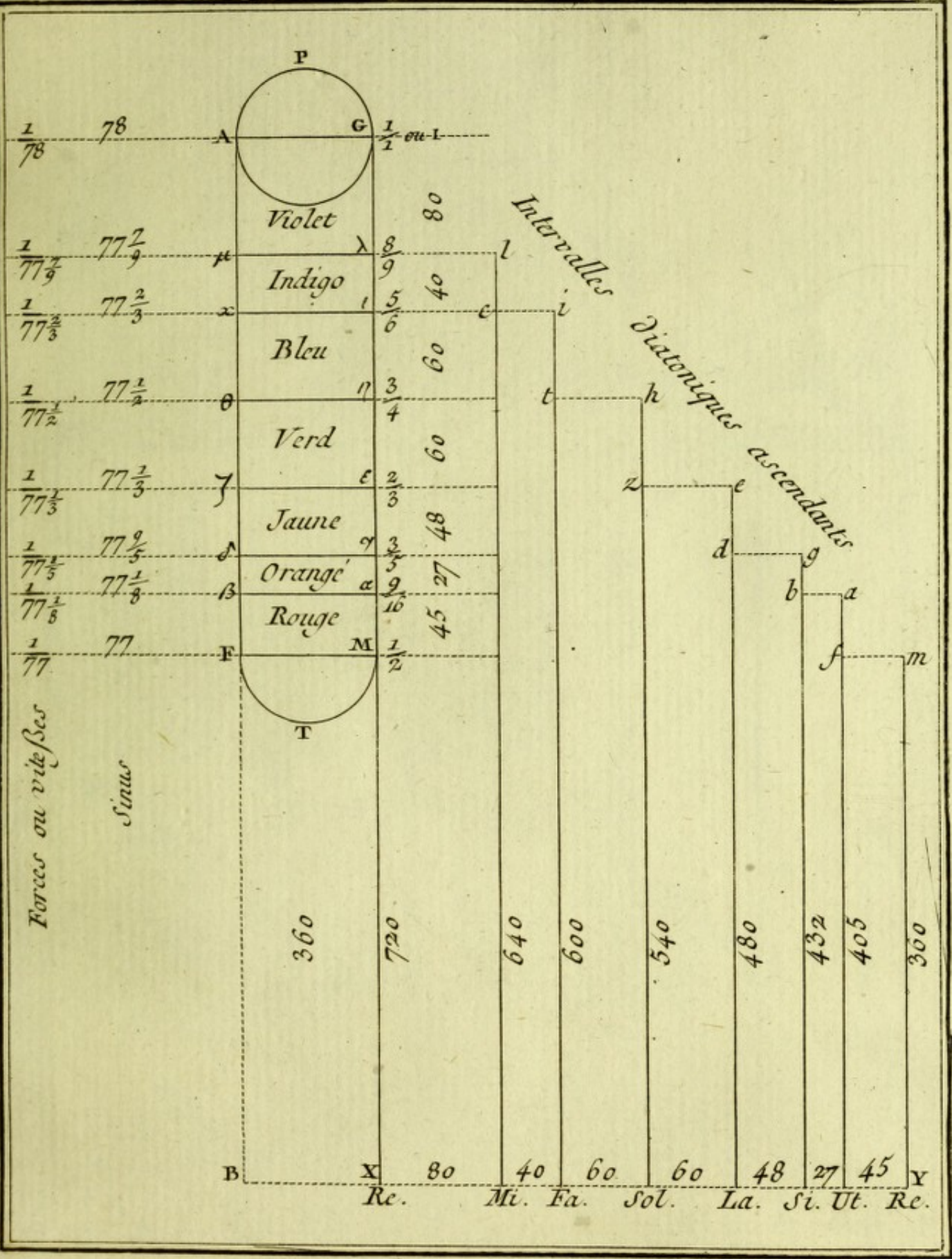






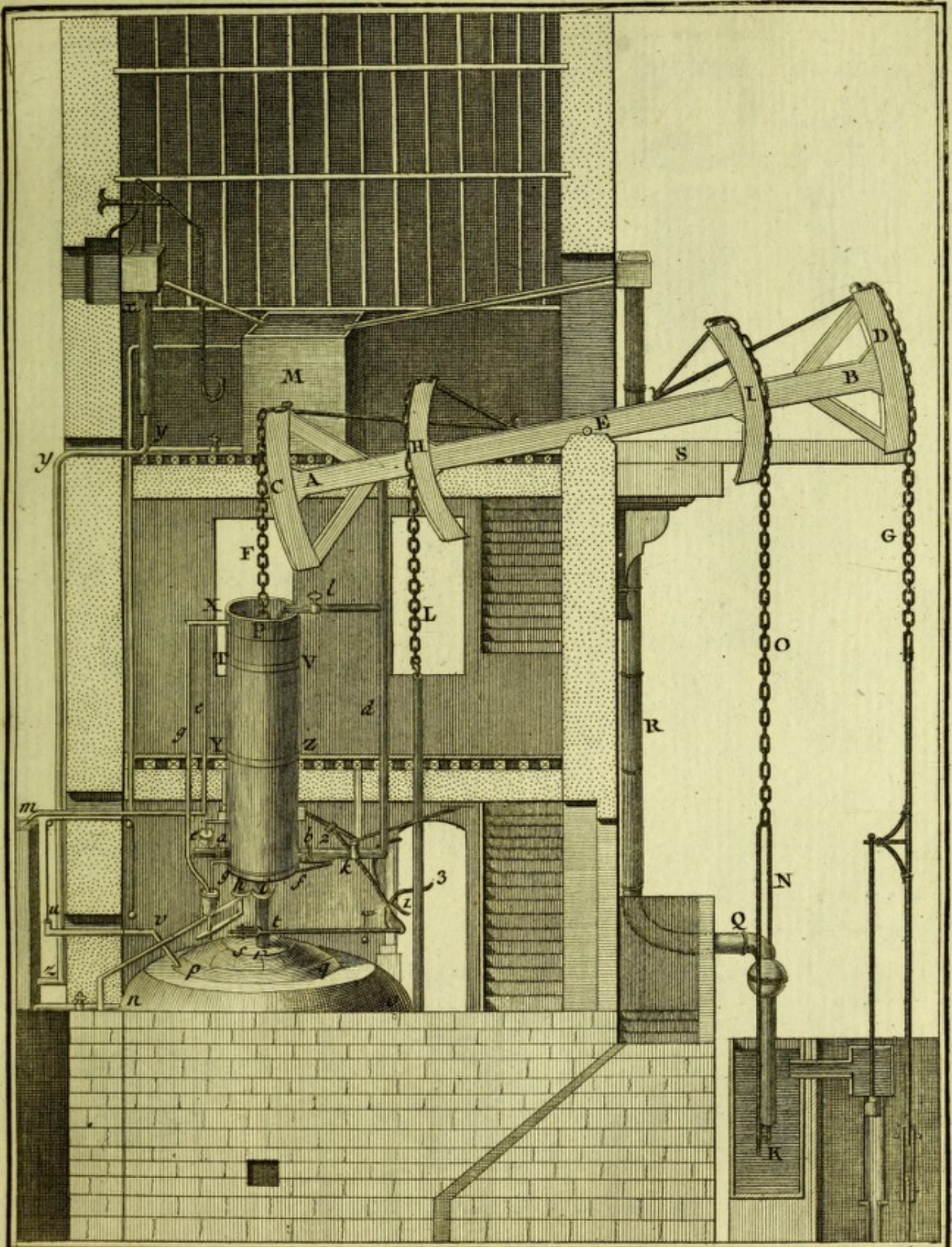
135 13





Physique.

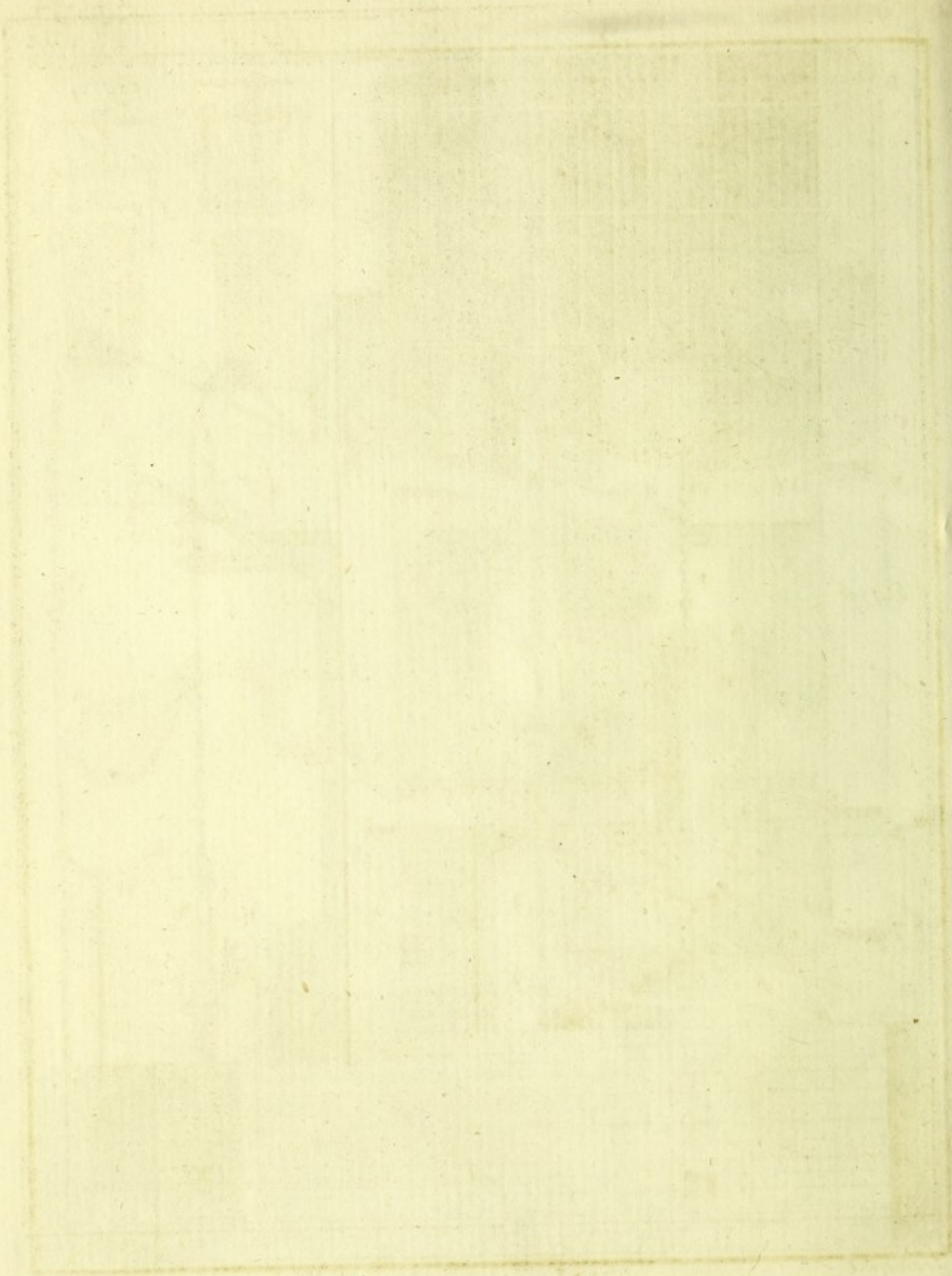
B. Drexel.



Fossier Del.

Physique.

Benard Diresit



Faint, illegible text or markings at the bottom center of the page.

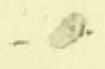


Fig. 1.

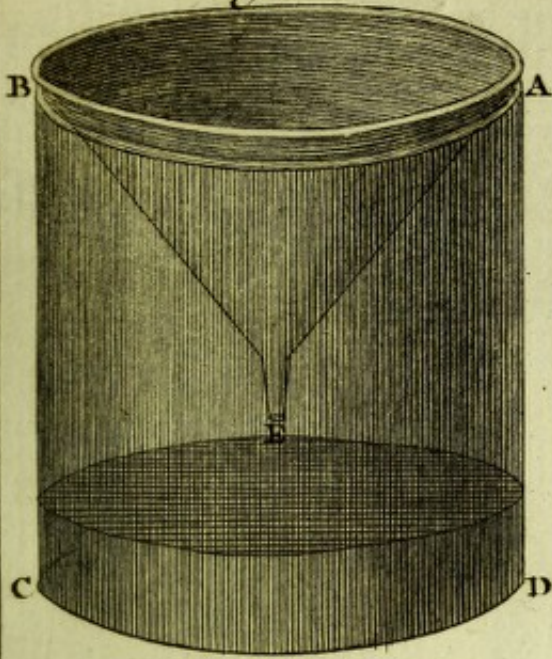


Fig. 2.



Fig. 3.



Fig. 4.

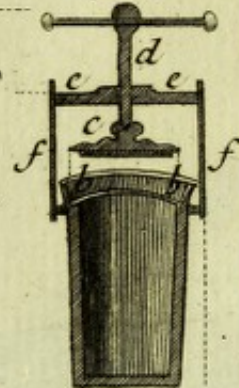


Fig. 5.

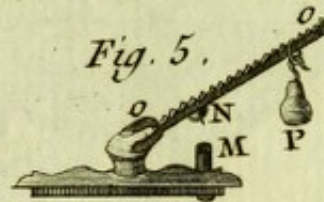


Fig. 9.



Fig. 8.



Fig. 7.

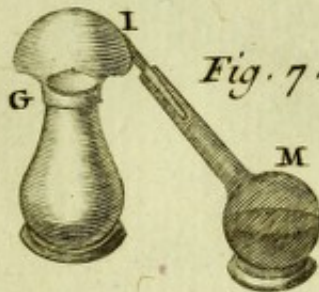


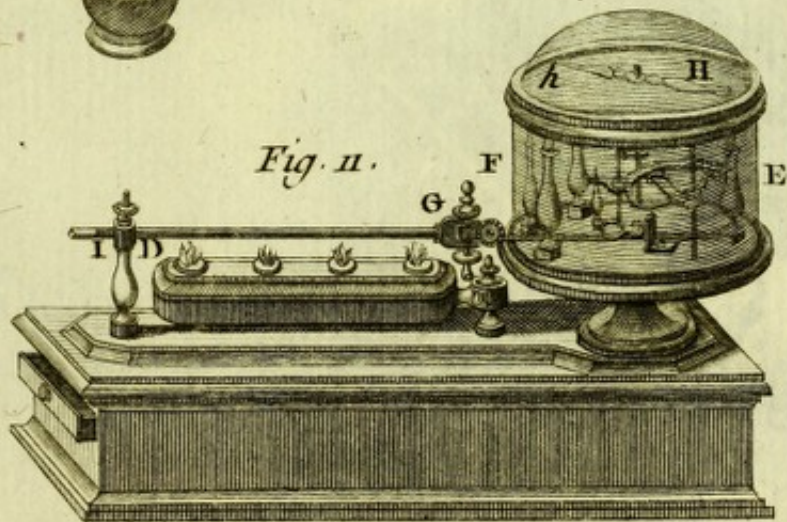
Fig. 10.

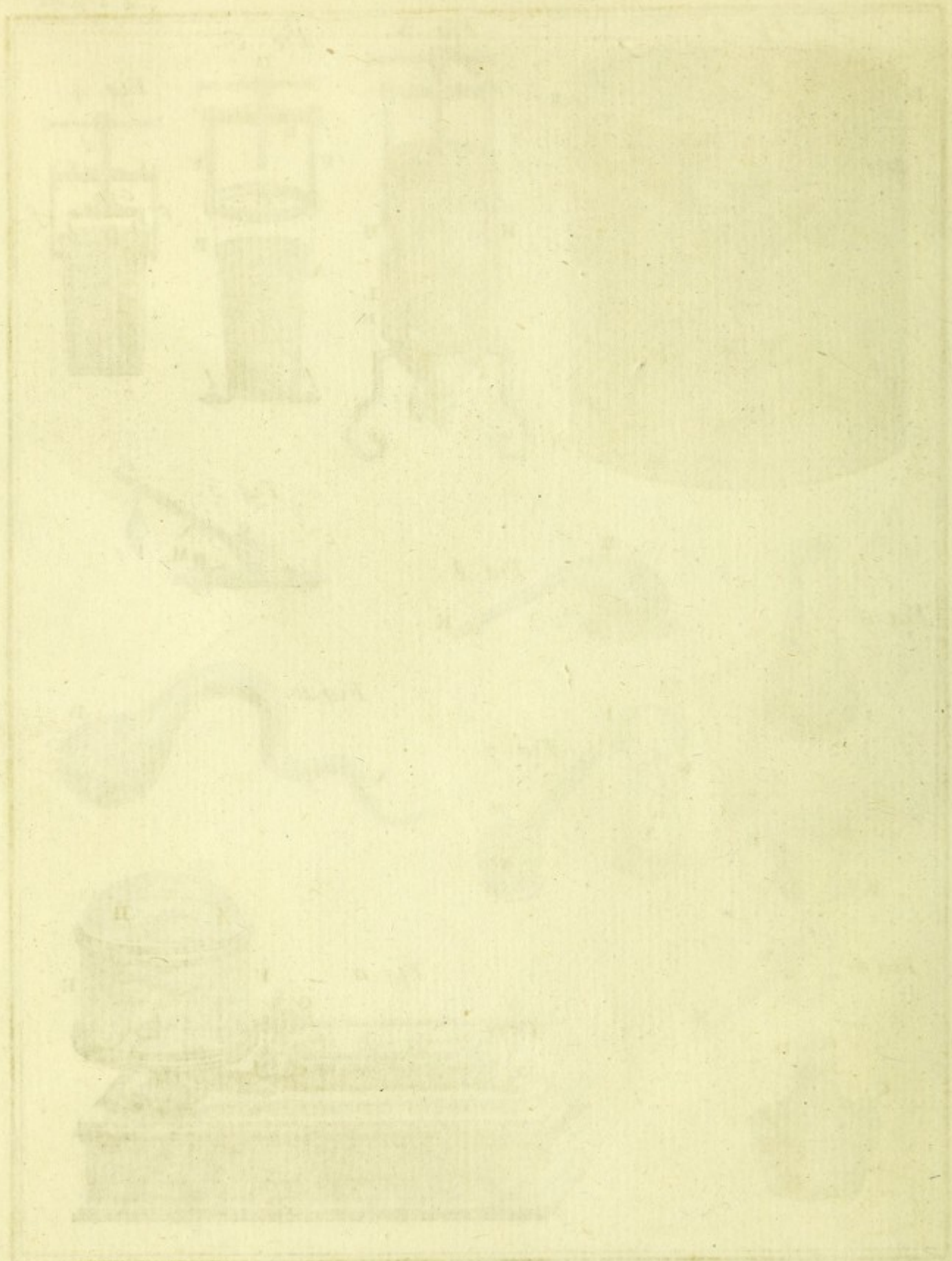


Fig. 6.



Fig. 11.

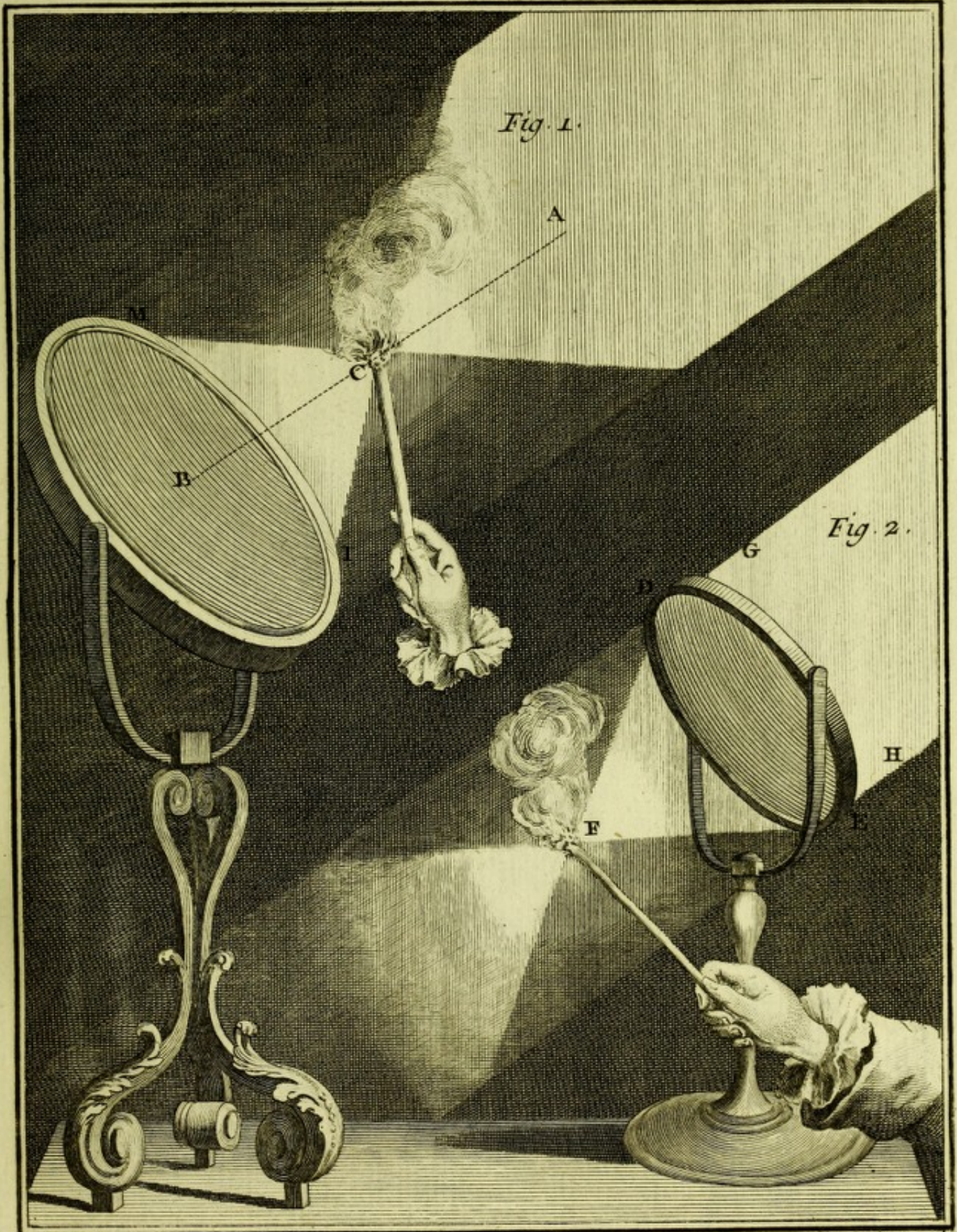




Thermopne

Fig. 1.

Fig. 2.



Fossier Del.

Benard Duxit

Physique.



Correspondance des Thermometres.

| I | II | III | IV | V | VI | VII | VIII | IX | X | XI | XII | XIII | XIV |
|---------|----------|----------|------------|-----------|----------|----------------------------------|----------|--------------|-----------|-----------|---------|-----------|-------------|
| De Luc. | De Luc. | Reaumur. | Farenheit. | De Ulsk. | La Hire. | Amon-ton. | Hales. | New-ton. | Bris-son. | Bris-son. | De Luc. | De Luc. | Centi-grade |
| ♀ | E. d. v. | E. d. v. | ♀ | ♀ | E. d. v. | Air | E. d. v. | Huile de Lin | ♀ | E. d. v. | ♀ | ♀ | ♀ |
| 80. | 80. | 100,4. | 212 | 0. | | 73 ^p . 0 ^l | | 33. 86. | 87. | 102. 8. | 84. | 147. | 100. |
| 75. | 73, 8. | 92, 6. | 200. 75 | 9. 375. | | | | 31. 74. | 81. 5. | 94. 8. | 78. | 135. 375. | 93. 75. |
| 70. | 67, 8. | 85. | 189. 5. | 18. 75. | | | | 29. 63. | 76. 1. | 87. 1. | 72. | 123. 75. | 87. 5. |
| 66. 6. | 63, 7. | 80. | 181. 85. | 25. 125. | | | | 28. 19. | 72. 4. | 81. 8. | 67. 92 | 115. 845. | 83. 25. |
| 65. | 61, 9. | 77, 6. | 178. 25 | 28. 125. | | | | 27. 51. | 70. 7. | 79. 6. | 66. | 112. 125 | 81. 25. |
| 60. | 56, 2. | 70, 5. | 167. | 37. 5. | | | | 25. 39. | 65. 2. | 72. 3. | 60. | 100. 5. | 75. |
| 55. | 50, 7. | 63, 7. | 155. 75. | 46. 875. | | | | 23. 28. | 59. 8. | 65. 2. | 54. | 88. 875. | 68. 75. |
| 50. | 45, 3. | 57, 1. | 144. 5. | 56. 25. | | | | 21. 16. | 54. 3. | 58. 3. | 48. | 77. 25. | 62. 5. |
| 45. | 40, 1. | 50, 7. | 133. 25 | 65. 625. | | | | 19. 04. | 48. 9. | 51. 6. | 42. | 65. 625 | 56. 25. |
| 40. | 35, 1. | 44, 5. | 122. | 75. | | | | 16. 93. | 43. 5. | 45. 1. | 36. | 54. | 50. |
| 35. | 30, 2. | 38, 5. | 110. 75. | 84. 375. | | | | 14. 81. | 38. | 38. 8. | 30. | 42. 375. | 43. 75. |
| 30. | 25, 5. | 32, 6. | 99. 5. | 93. 75. | 86. 12. | | 56. 95. | 12. 69. | 32. 6. | 32. 7. | 24. | 30. 75. | 37. 5. |
| 29. 9. | 25, 4. | 32, 5. | 99. 225. | 93. 937. | 85. 92. | 60. 3. | 56. 66. | 12. 65. | 32. 5. | 32. 5. | 23. 88. | 30. 518. | 37. 3775. |
| 25. | 20, 9. | 26, 7. | 88. 25. | 103. 125. | 76. 13. | | 47. 05. | 10. 57. | 27. 2. | 26. 8. | 18. | 19. 125. | 31. 25. |
| 20. | 16, 4. | 21, 1. | 77. | 112. 5. | 66. 49. | | 37. 17. | 8. 46. | 21. 7. | 21. 1. | 12. | 7. 5. | 25. |
| 15. | 12, 1. | 15, 7. | 65. 75. | 121. 875. | 57. 13. | | 27. 48. | 6. 35. | 16. 3. | 15. 6. | 6. | 4. 125. | 18. 75. |
| 10. | 7, 9. | 10, 4. | 54. 5. | 131. 25 | 48. 6. | | 17. 93. | 4. 24. | 10, 9. | 10. 3 | 0. | 15. 75. | 12. 5. |
| 9. 6. | 7, 6. | 10, 25. | 53. 6. | 132. | 47. 93. | 54. 3. | 17. 20. | 4. 07. | 10. 4. | 10. 2. | 0. 48. | 16. 68. | 11. 9. |
| 5. | 3, 9. | 5, 1. | 43. 25 | 140. 625. | 40. 22. | | 8. 82. | 2. 12. | 5. 4. | 5. 1. | 6. | 27. 375. | 6. 25. |
| 0. | 0. | 0. | 32. | 150. | 31. 86. | 51. 6. | 0. | 0. | 0. | 0. | 12. | 39. | 0. |
| 5. | 3, 8. | 4, 7. | 20. 75. | 159. 375. | 23. 87. | | 8. 60. | 2. 12. | 5. 4. | 4. 9. | 18. | 50. 625 | 6. 25. |
| 10. | 7, 5. | 9, 3. | 9. 5. | 168. 75. | 16. 26. | | 17. 25. | 4. 24. | 10. 9. | 9. 6. | 24. | 62. 25 | 12. 5. |
| 15. | 11, 1. | 13, 9. | 1. 75 | 178. 125. | 8. 04. | | 25. 81. | 6. 35. | 16. 3. | 14. 1. | 30. | 73. 875 | 18. 75. |
| 17. | 12, 7. | 15, 7. | 6. 25 | 181. 875. | 4. 93. | | | 7. 20. | 18. 5. | 15. 9. | 32. 4 | 78. 525 | 21. 25 |
| 20. | 14, 5. | 18, 4. | 13. | 187. 5. | | | | 8. 46. | 21. 7. | 18. 4 | 36. | 85. 5. | 25. |
| 25. | 17, 8. | 22, 8. | 24. 25. | 196. 875. | | | | 10. 57. | 27. 2. | 22. 5. | 42. | 97. 125. | 31. 25. |
| 30. | 21. | 27, 1. | 35. 5. | 206. 25 | | | | 12. 69. | 32. 6. | 26. 4 | 48. | 108. 75. | 37. 5. |
| 35. | 24, 1. | 31, 3. | 46. 75. | 215. 625. | | | | 14. 81. | 38. | 30. 1. | 54. | 120. 625 | 43. 75. |
| 40. | 27, 1 | 35, 4. | 58. | 225. | | | | 16. 93. | 43. 5. | 33. 6. | 60. | 132. | 50. |
| 45. | 30. | 39, 4. | 69. 25. | 234. 375. | | | | 19. 04. | 48. 9. | 36. 9. | 66. | 143. 625 | 56. 25. |
| 50. | 32, 8. | 43, 3. | 80. 5. | 243. 75. | | | | 22. 16. | 54. 3. | 40. | 72. | 155. 25. | 62. 5. |
| 55. | 35, 5. | 47, 1 | 91. 75. | 253. 125. | | | | 23. 28. | 59. 8. | 42. 9. | 78. | 166. 875 | 68. 75. |
| 60. | 38, 1. | 50, 8. | 103. | 262. 5. | | | | 25. 39. | 65. 2. | 45. 6. | 84. | 178. 5 | 75. |

| Year | Month | Day | Particulars | Debit | Credit | Balance |
|------|-------|-----|-----------------|-------|--------|---------|
| 1880 | Jan | 1 | Balance forward | | | |
| 1880 | Jan | 2 | To Cash | | 100 | 100 |
| 1880 | Jan | 3 | By Cash | 50 | | 50 |
| 1880 | Jan | 4 | To Cash | | 200 | 250 |
| 1880 | Jan | 5 | By Cash | 100 | | 150 |
| 1880 | Jan | 6 | To Cash | | 150 | 300 |
| 1880 | Jan | 7 | By Cash | 150 | | 150 |
| 1880 | Jan | 8 | To Cash | | 100 | 250 |
| 1880 | Jan | 9 | By Cash | 100 | | 150 |
| 1880 | Jan | 10 | To Cash | | 150 | 300 |
| 1880 | Jan | 11 | By Cash | 150 | | 150 |
| 1880 | Jan | 12 | To Cash | | 100 | 250 |
| 1880 | Jan | 13 | By Cash | 100 | | 150 |
| 1880 | Jan | 14 | To Cash | | 150 | 300 |
| 1880 | Jan | 15 | By Cash | 150 | | 150 |
| 1880 | Jan | 16 | To Cash | | 100 | 250 |
| 1880 | Jan | 17 | By Cash | 100 | | 150 |
| 1880 | Jan | 18 | To Cash | | 150 | 300 |
| 1880 | Jan | 19 | By Cash | 150 | | 150 |
| 1880 | Jan | 20 | To Cash | | 100 | 250 |
| 1880 | Jan | 21 | By Cash | 100 | | 150 |
| 1880 | Jan | 22 | To Cash | | 150 | 300 |
| 1880 | Jan | 23 | By Cash | 150 | | 150 |
| 1880 | Jan | 24 | To Cash | | 100 | 250 |
| 1880 | Jan | 25 | By Cash | 100 | | 150 |
| 1880 | Jan | 26 | To Cash | | 150 | 300 |
| 1880 | Jan | 27 | By Cash | 150 | | 150 |
| 1880 | Jan | 28 | To Cash | | 100 | 250 |
| 1880 | Jan | 29 | By Cash | 100 | | 150 |
| 1880 | Jan | 30 | To Cash | | 150 | 300 |
| 1880 | Jan | 31 | By Cash | 150 | | 150 |
| 1880 | Feb | 1 | Balance forward | | | 150 |
| 1880 | Feb | 2 | To Cash | | 100 | 250 |
| 1880 | Feb | 3 | By Cash | 100 | | 150 |
| 1880 | Feb | 4 | To Cash | | 150 | 300 |
| 1880 | Feb | 5 | By Cash | 150 | | 150 |
| 1880 | Feb | 6 | To Cash | | 100 | 250 |
| 1880 | Feb | 7 | By Cash | 100 | | 150 |
| 1880 | Feb | 8 | To Cash | | 150 | 300 |
| 1880 | Feb | 9 | By Cash | 150 | | 150 |
| 1880 | Feb | 10 | To Cash | | 100 | 250 |
| 1880 | Feb | 11 | By Cash | 100 | | 150 |
| 1880 | Feb | 12 | To Cash | | 150 | 300 |
| 1880 | Feb | 13 | By Cash | 150 | | 150 |
| 1880 | Feb | 14 | To Cash | | 100 | 250 |
| 1880 | Feb | 15 | By Cash | 100 | | 150 |
| 1880 | Feb | 16 | To Cash | | 150 | 300 |
| 1880 | Feb | 17 | By Cash | 150 | | 150 |
| 1880 | Feb | 18 | To Cash | | 100 | 250 |
| 1880 | Feb | 19 | By Cash | 100 | | 150 |
| 1880 | Feb | 20 | To Cash | | 150 | 300 |
| 1880 | Feb | 21 | By Cash | 150 | | 150 |
| 1880 | Feb | 22 | To Cash | | 100 | 250 |
| 1880 | Feb | 23 | By Cash | 100 | | 150 |
| 1880 | Feb | 24 | To Cash | | 150 | 300 |
| 1880 | Feb | 25 | By Cash | 150 | | 150 |
| 1880 | Feb | 26 | To Cash | | 100 | 250 |
| 1880 | Feb | 27 | By Cash | 100 | | 150 |
| 1880 | Feb | 28 | To Cash | | 150 | 300 |
| 1880 | Feb | 29 | By Cash | 150 | | 150 |
| 1880 | Feb | 30 | To Cash | | 100 | 250 |
| 1880 | Feb | 31 | By Cash | 100 | | 150 |
| 1880 | Mar | 1 | Balance forward | | | 150 |

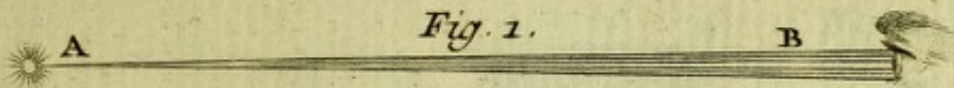


Fig. 1.

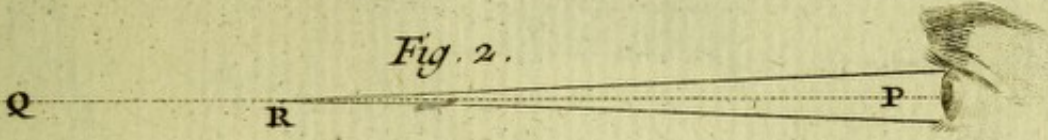


Fig. 2.

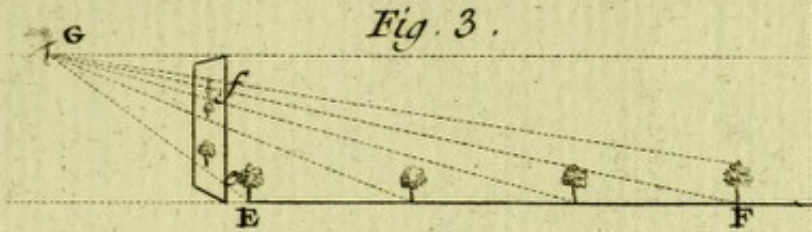


Fig. 3.

Fig. 4.

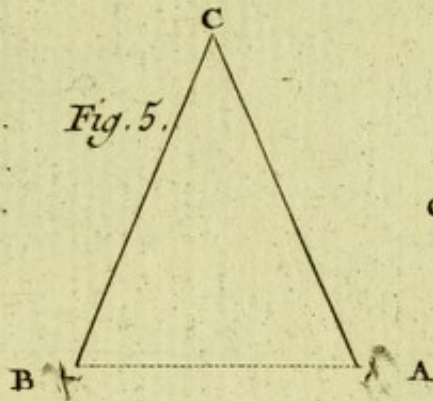
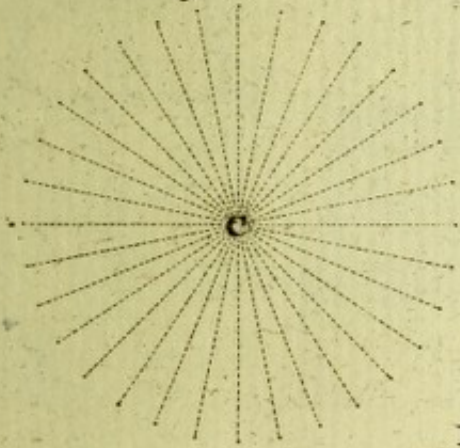


Fig. 5.

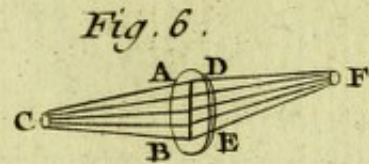


Fig. 6.

Fig. 7.

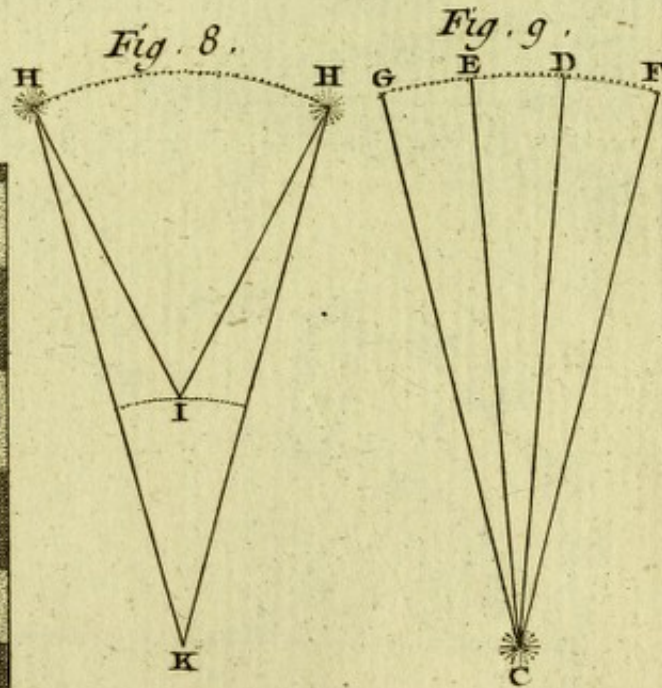
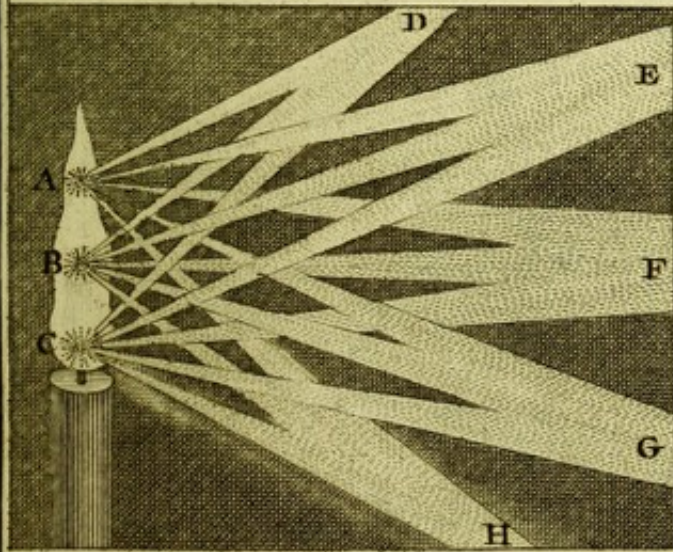
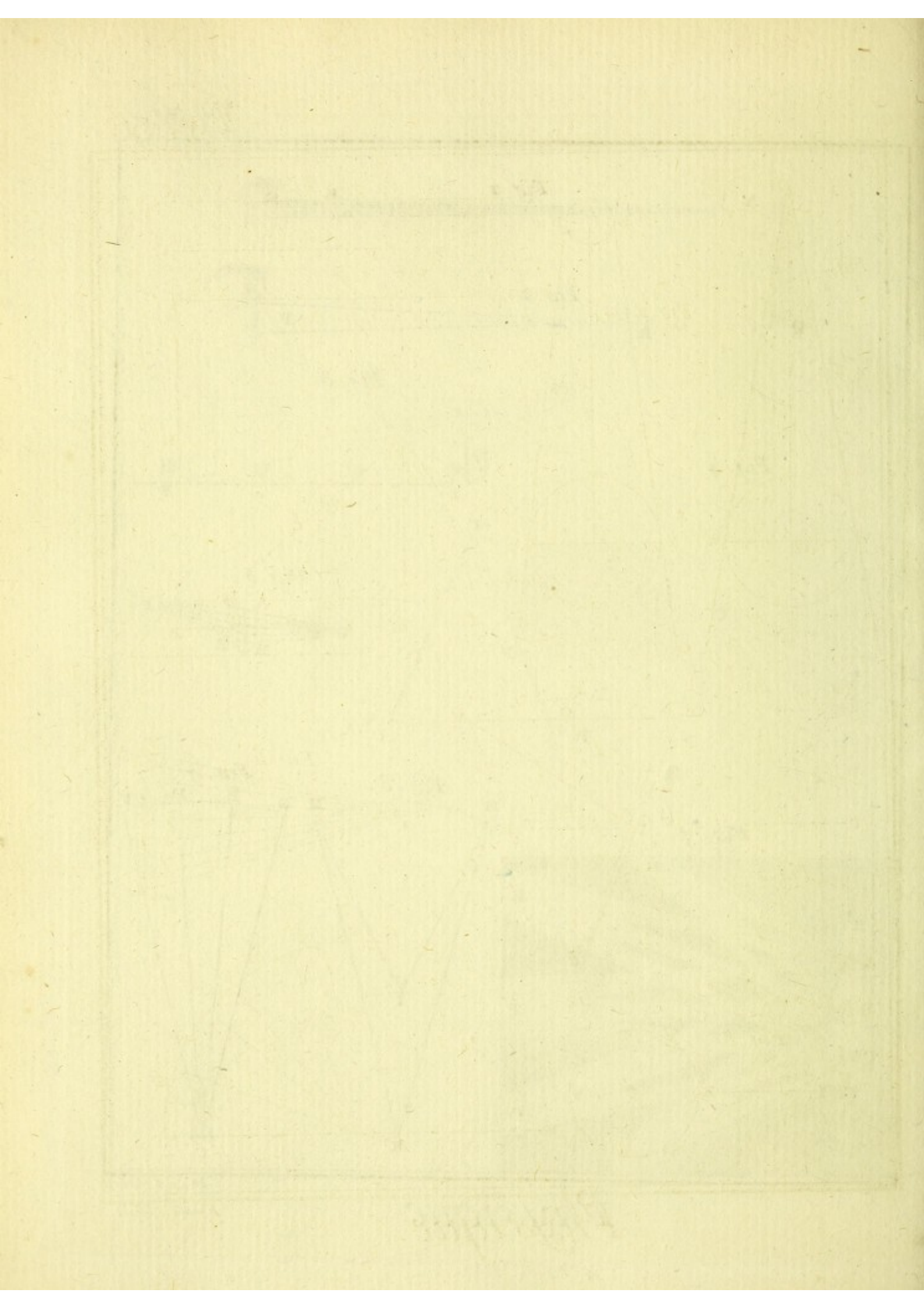
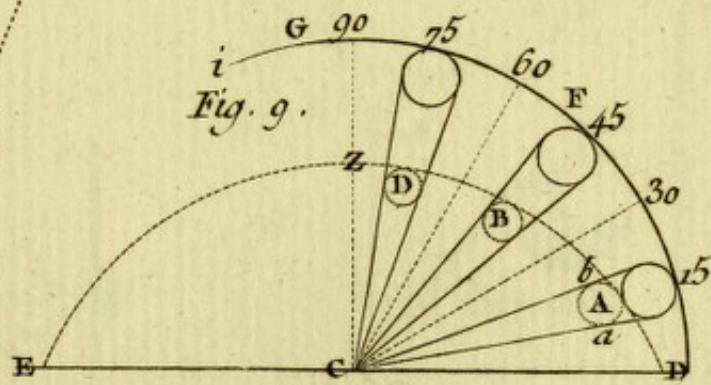
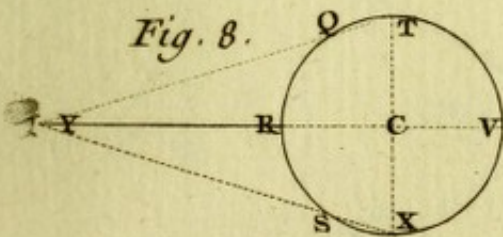
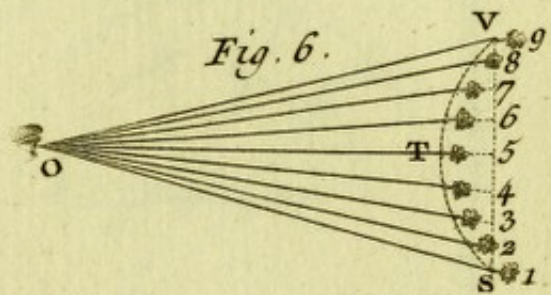
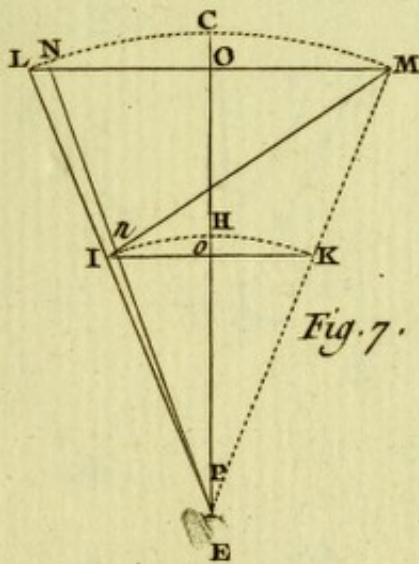
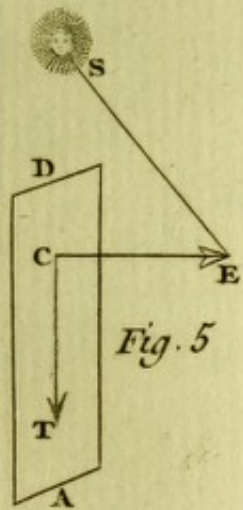
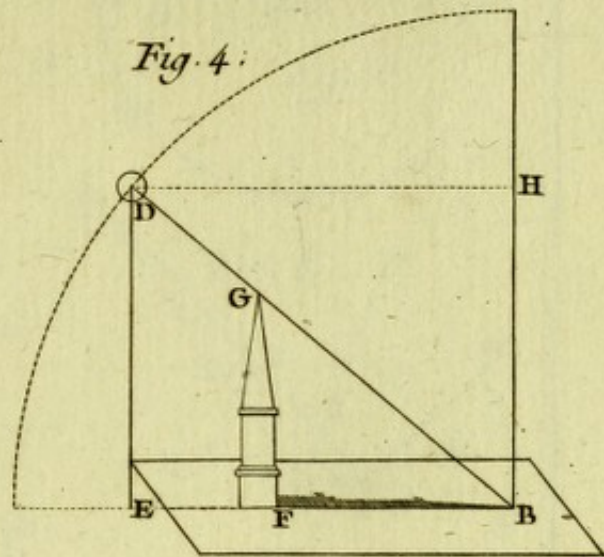
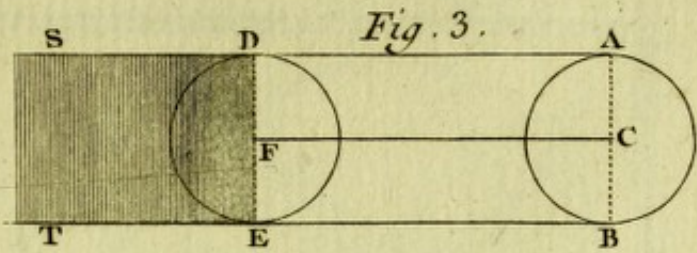
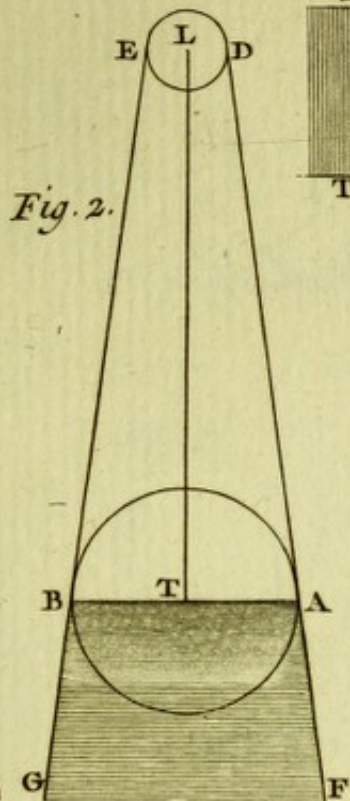
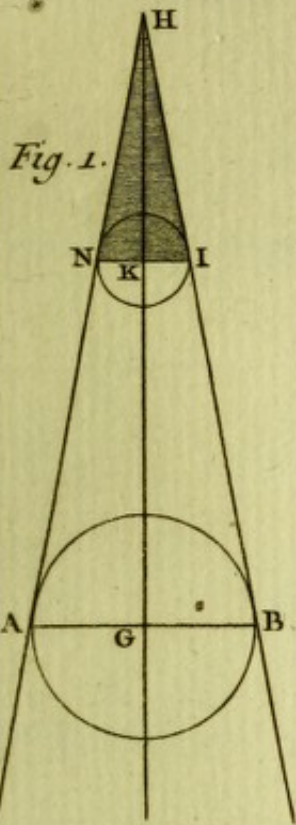


Fig. 8.

Fig. 9.





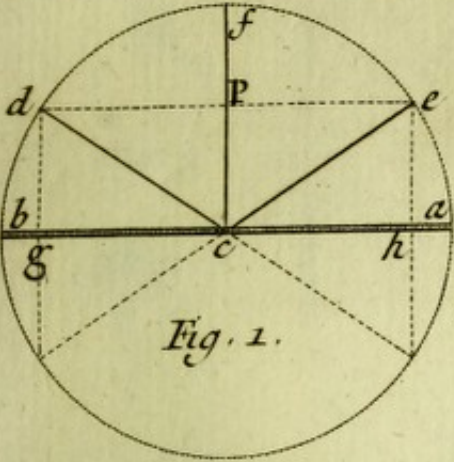


Fig. 1.

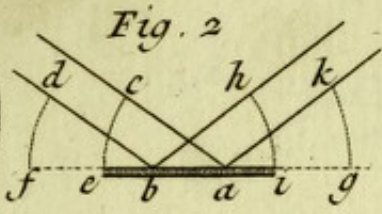


Fig. 2.

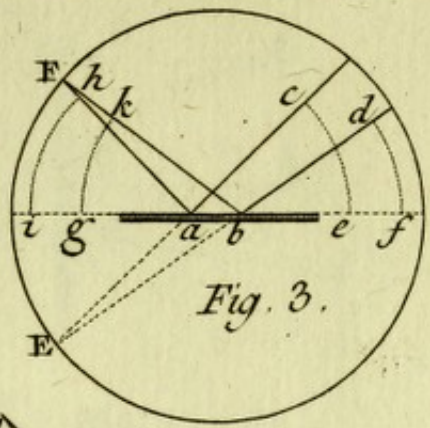


Fig. 3.

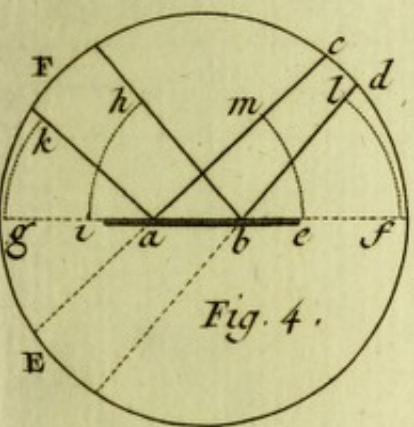


Fig. 4.

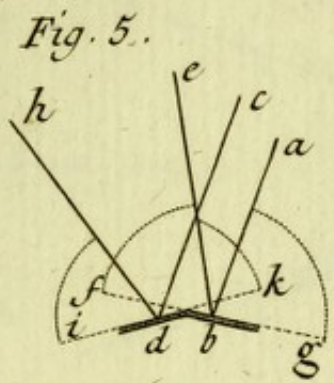


Fig. 5.

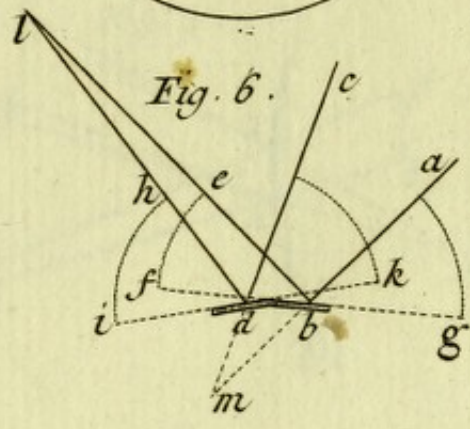


Fig. 6.

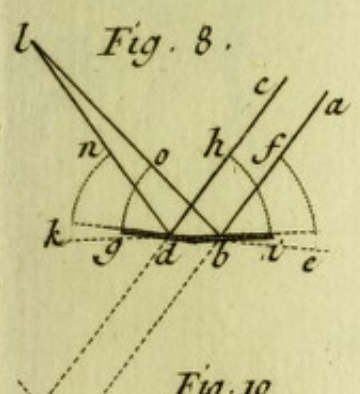


Fig. 8.

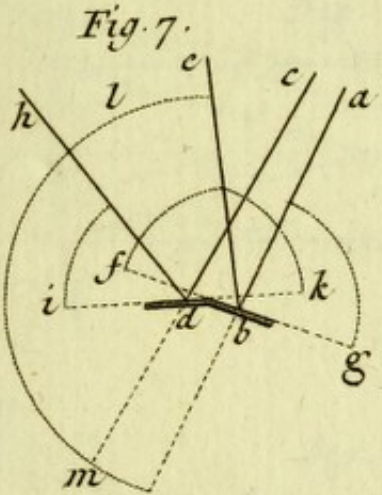


Fig. 7.

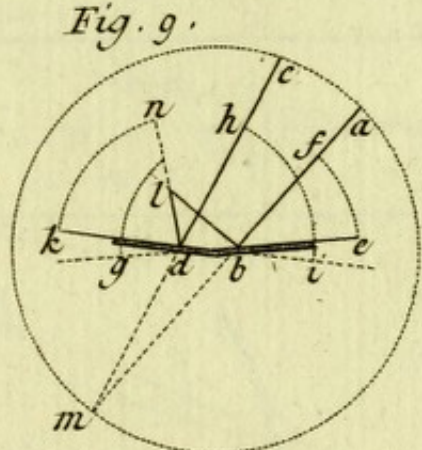


Fig. 9.

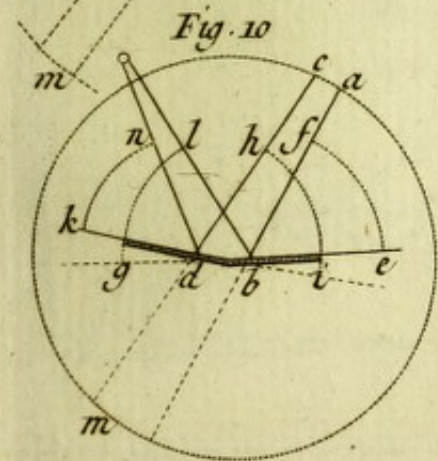


Fig. 10.

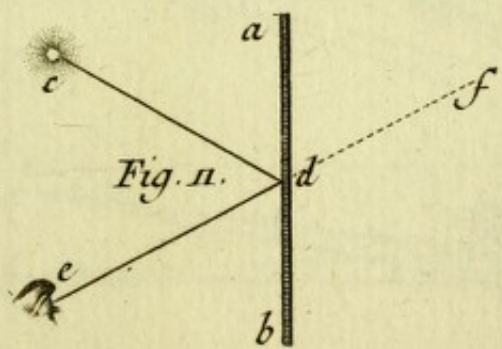


Fig. 11.

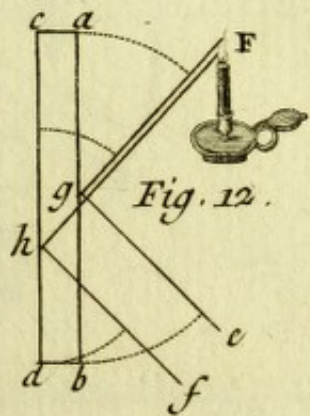
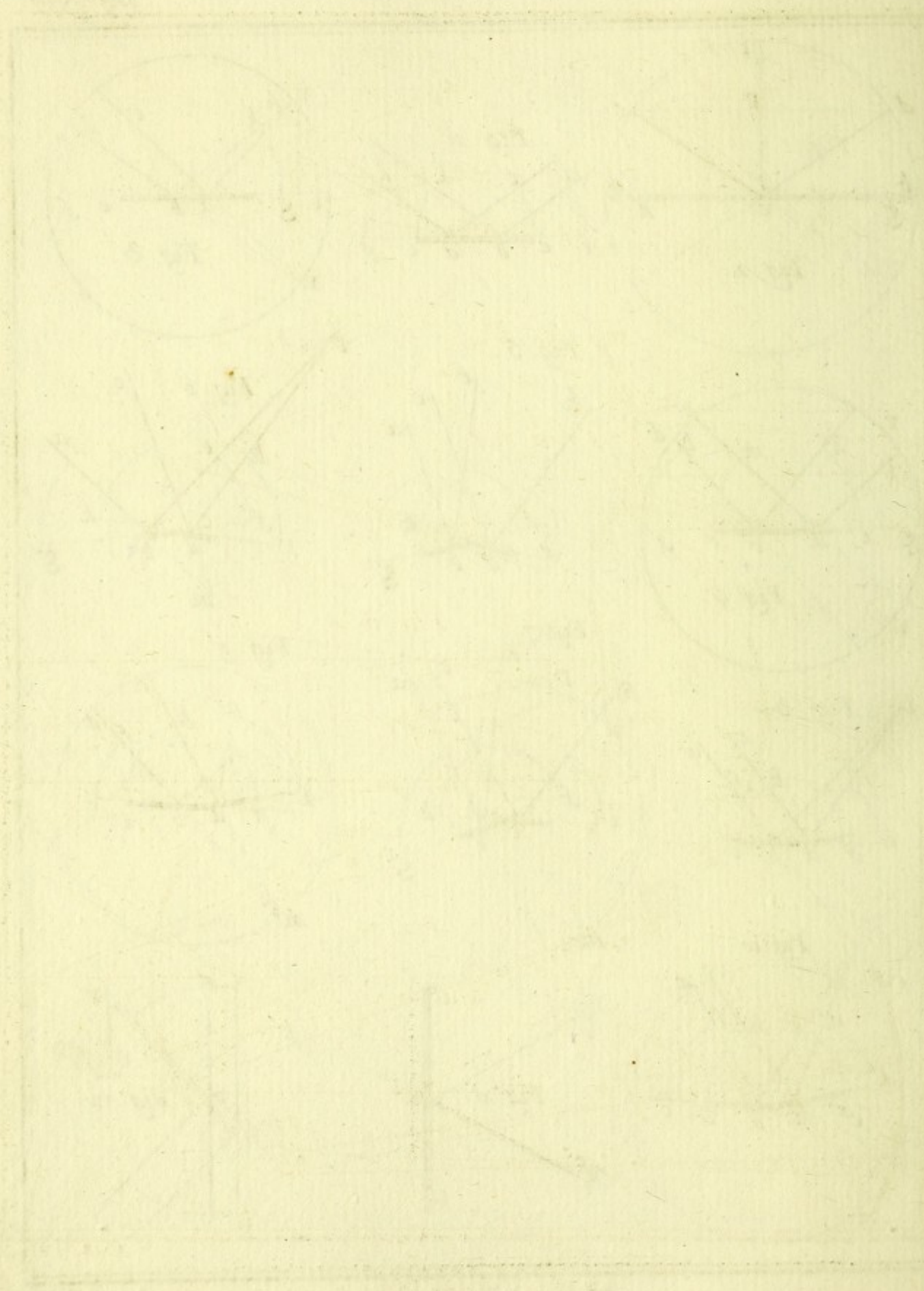


Fig. 12.



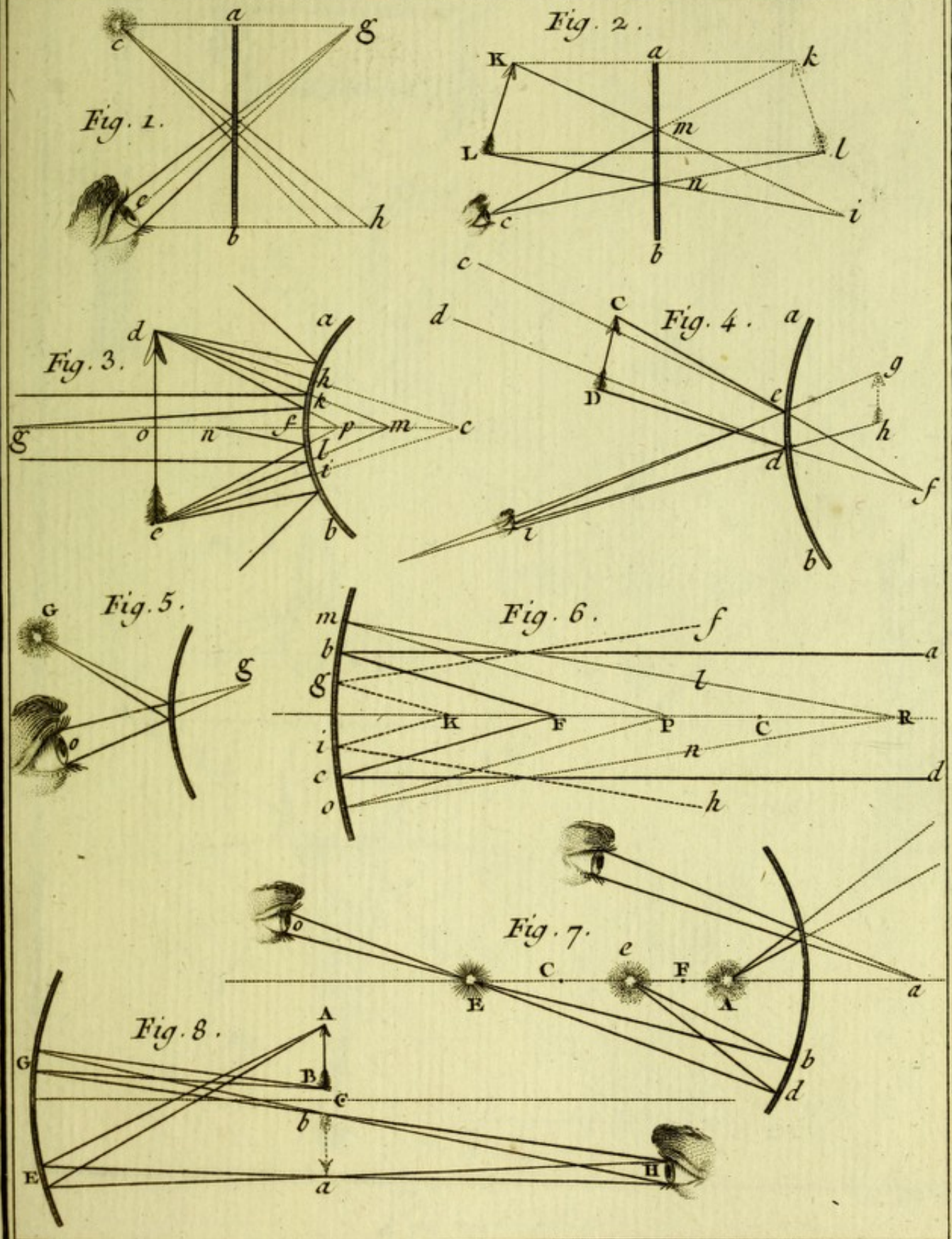


Fig. 1

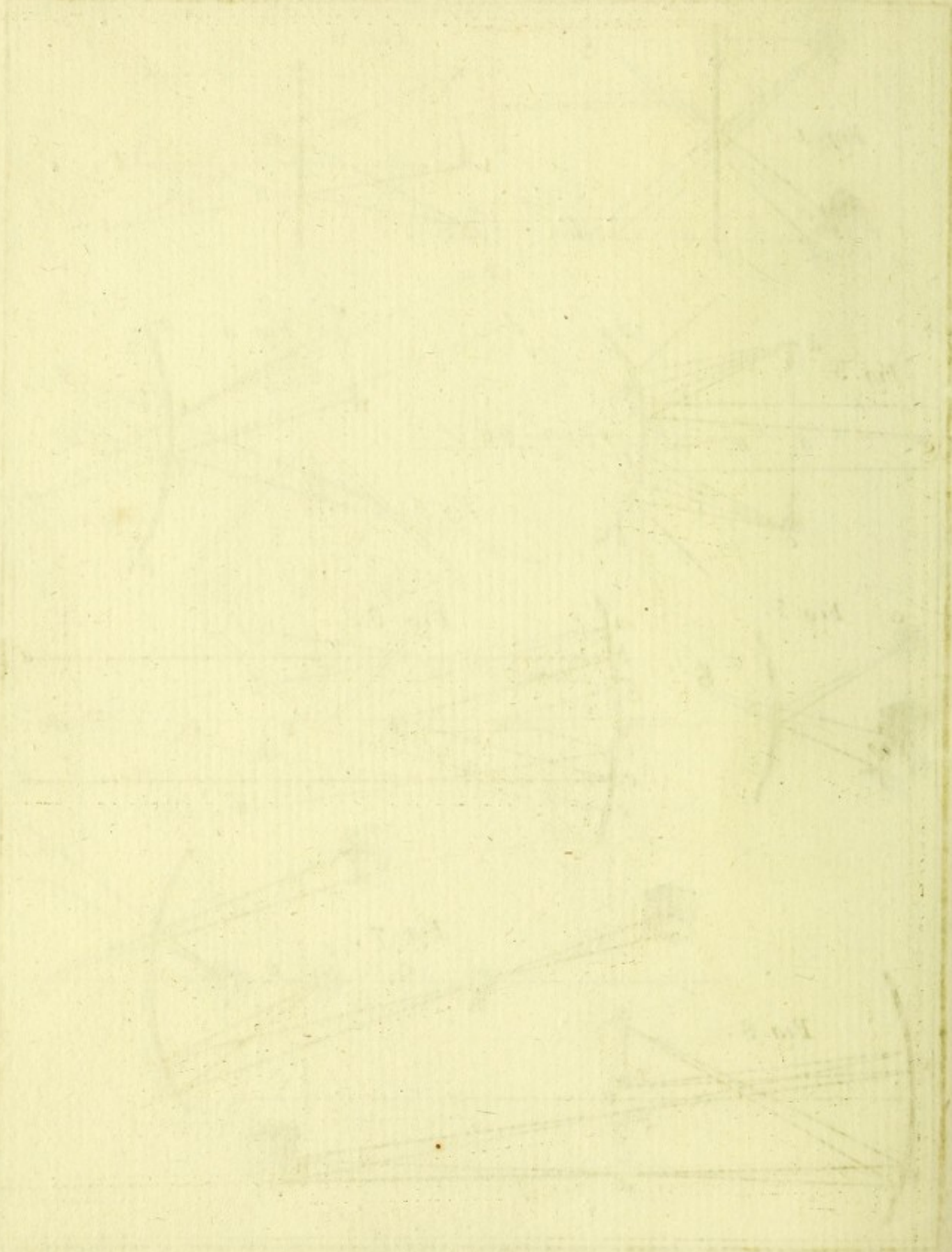
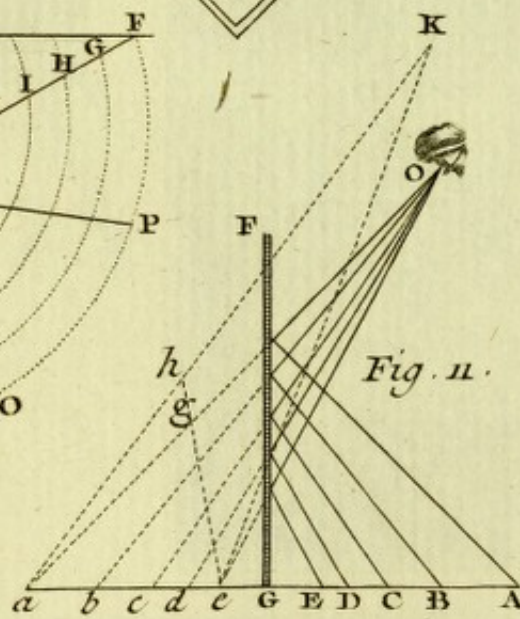
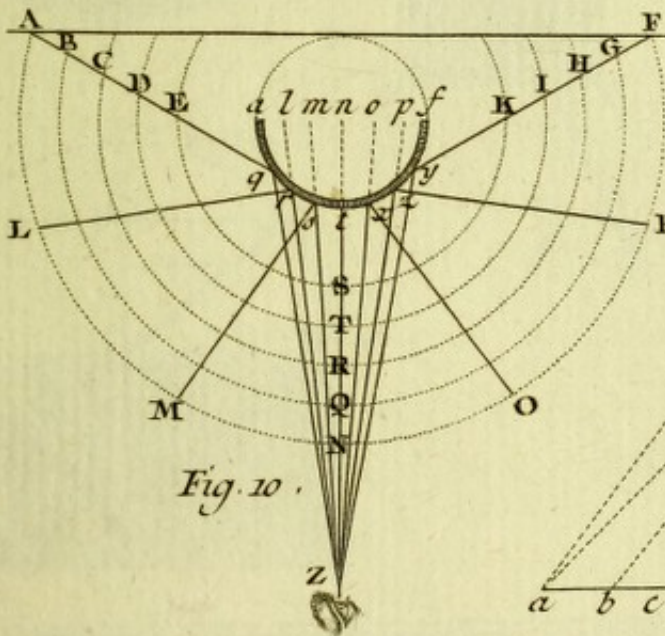
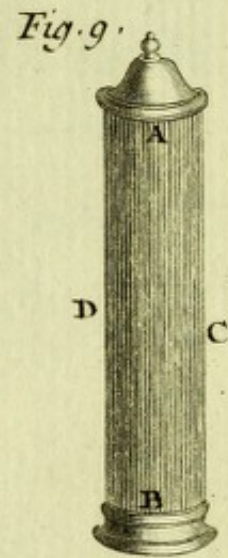
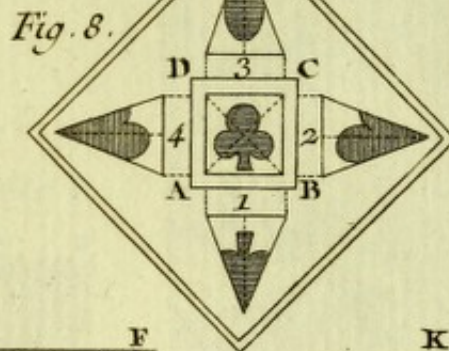
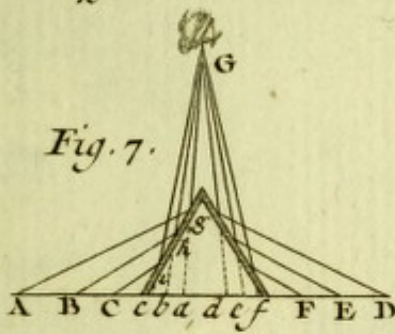
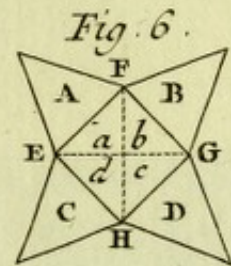
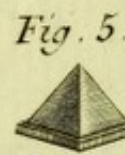
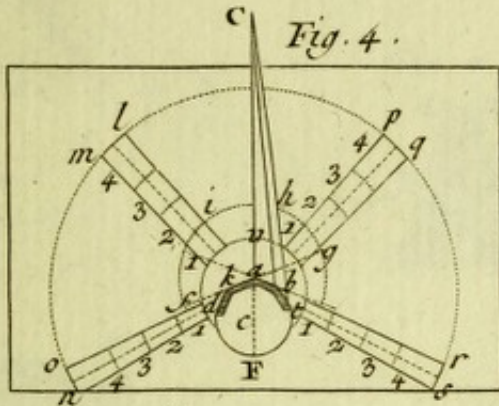
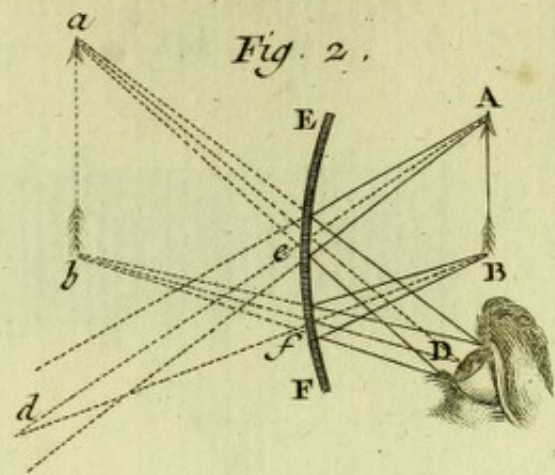
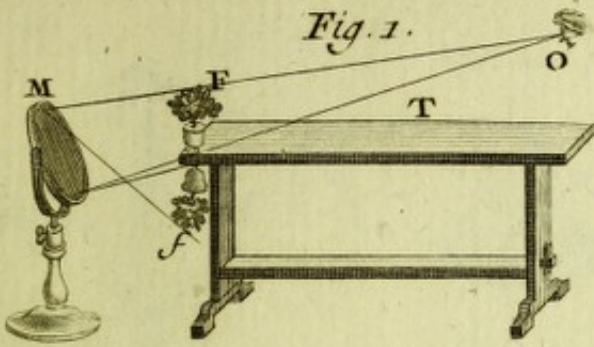
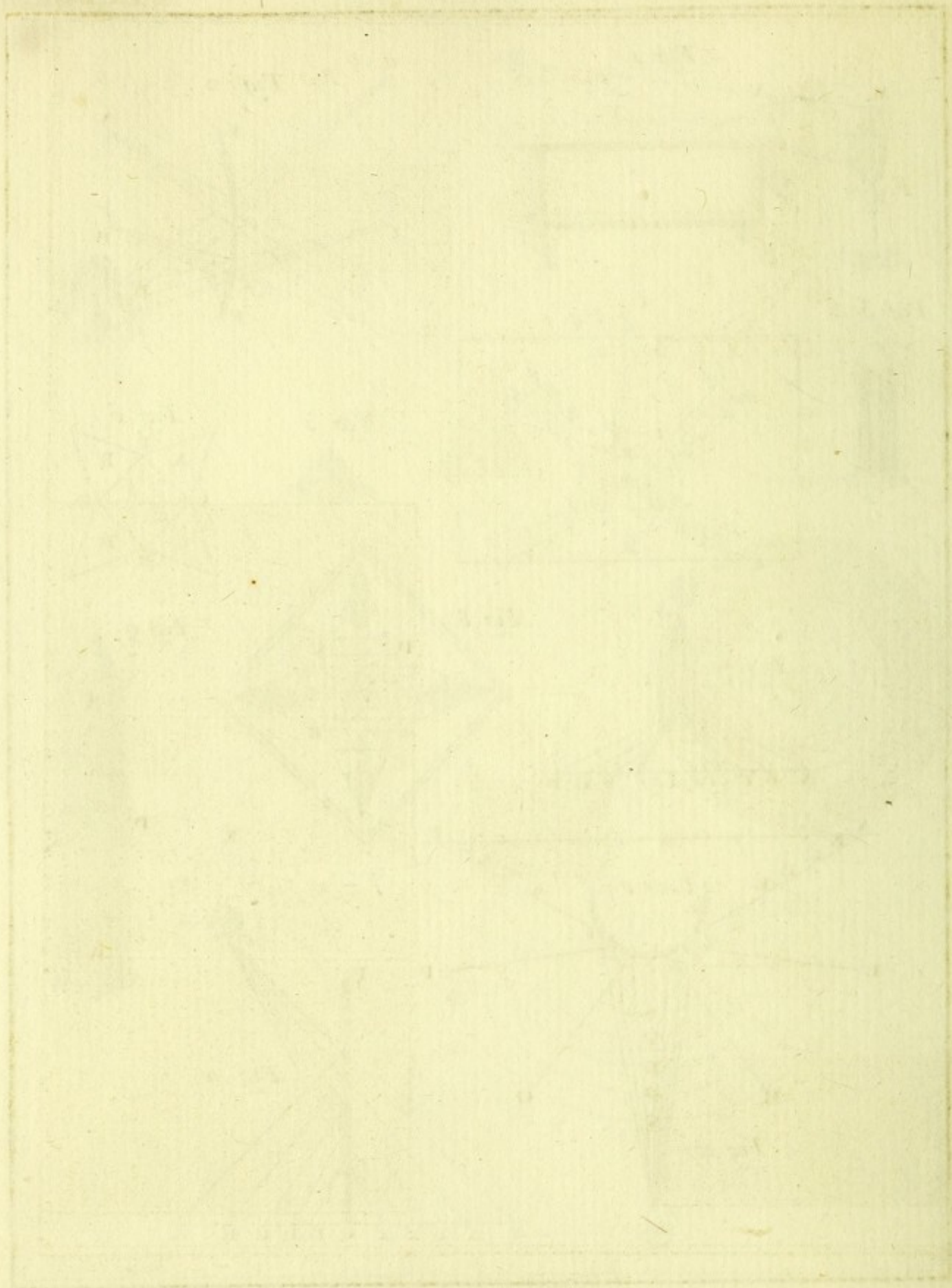
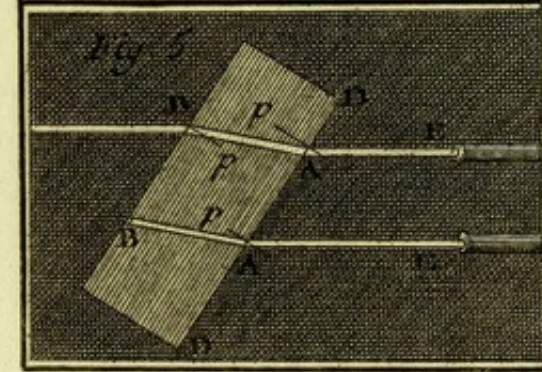
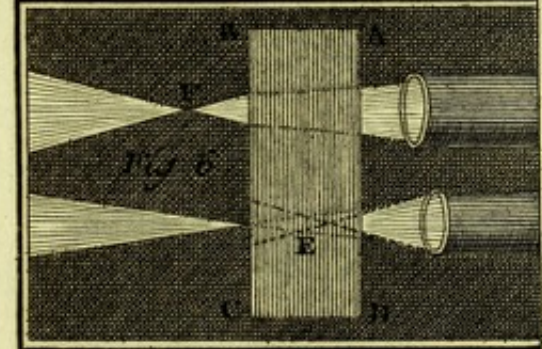
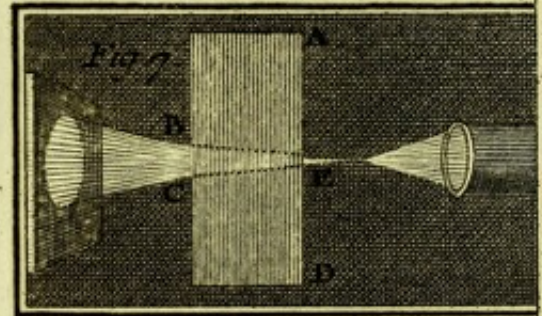
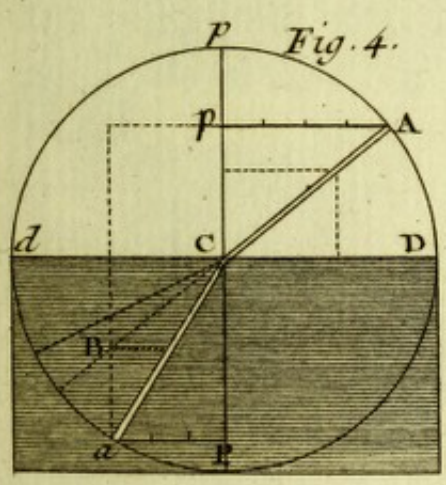
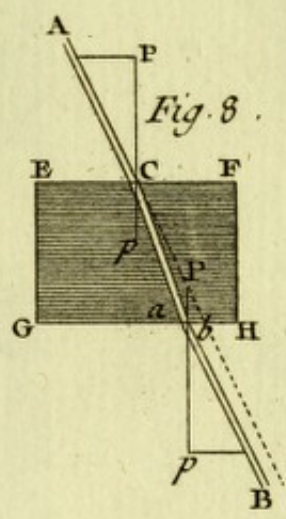
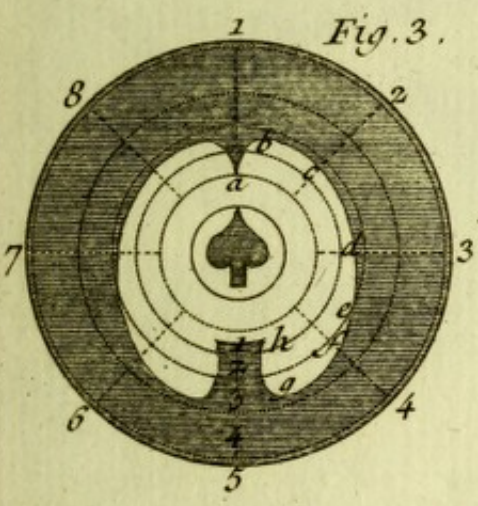
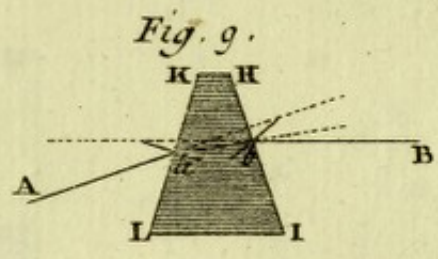
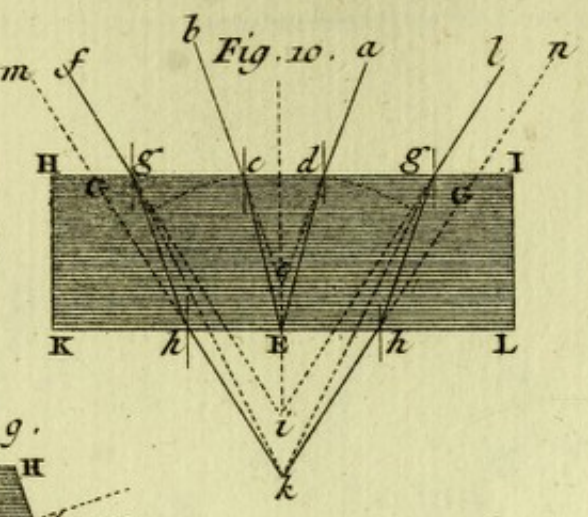
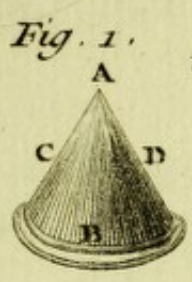
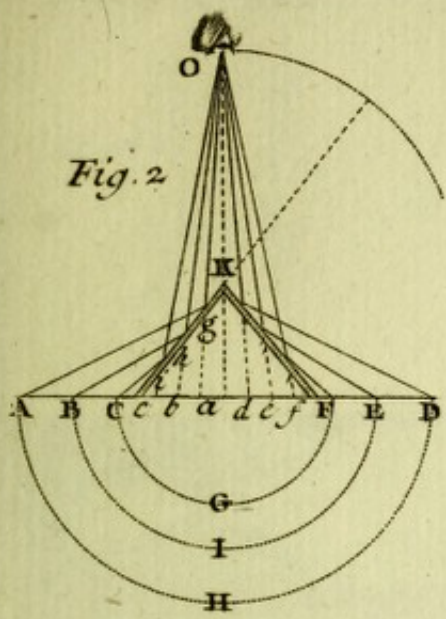
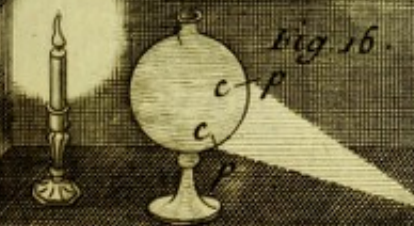
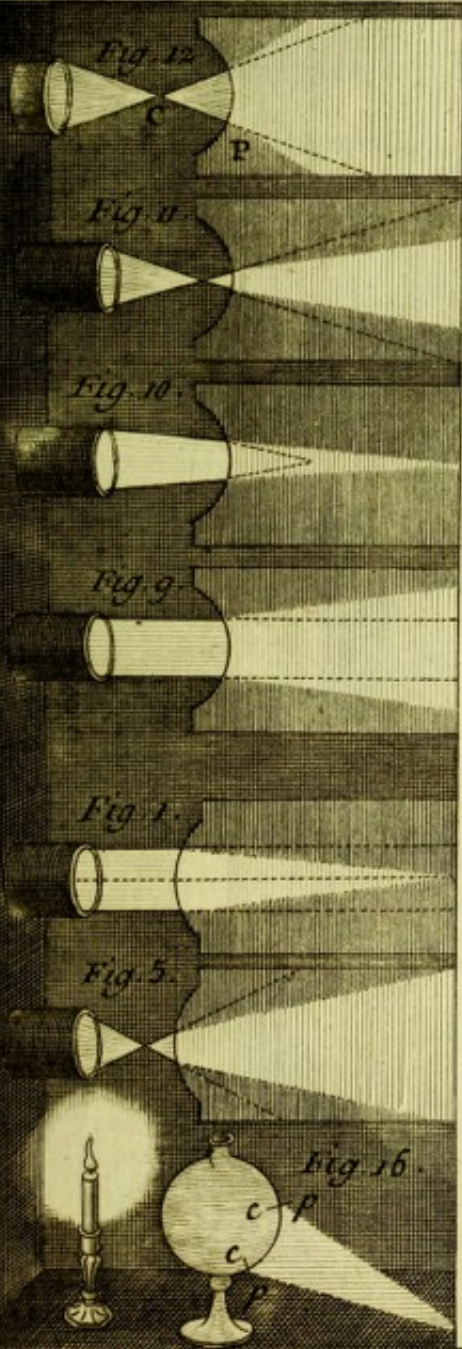
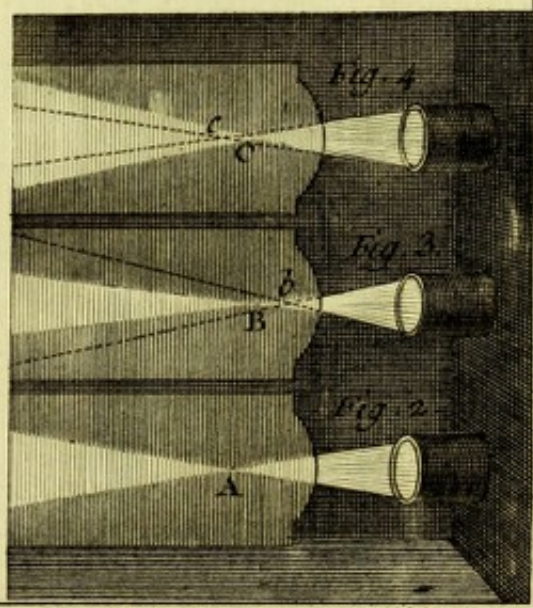
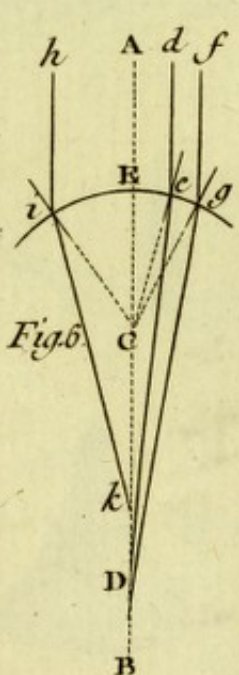
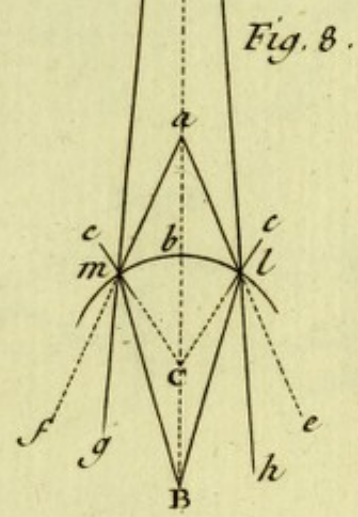
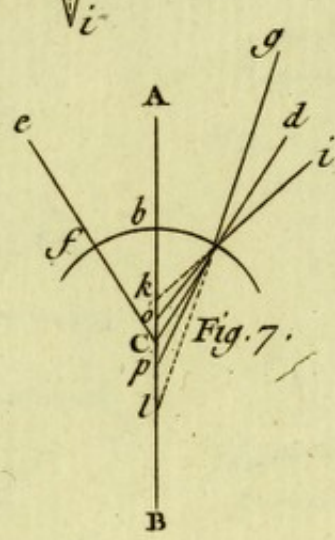
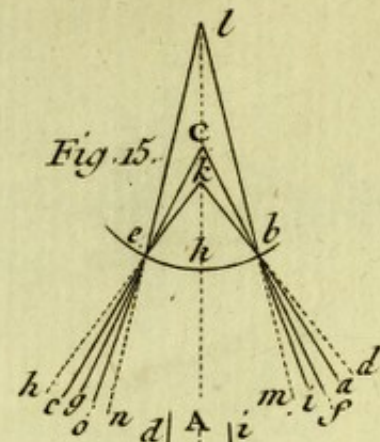
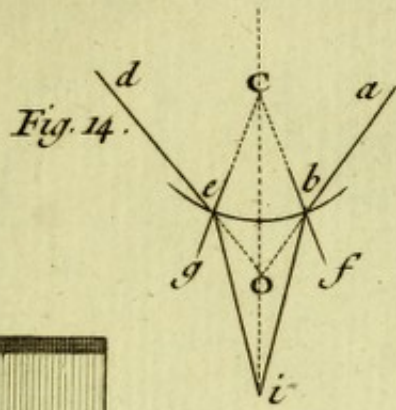
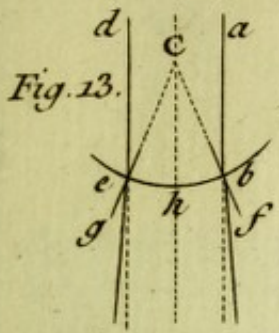


Fig. 1









Physique.

Benard. Duxcit.

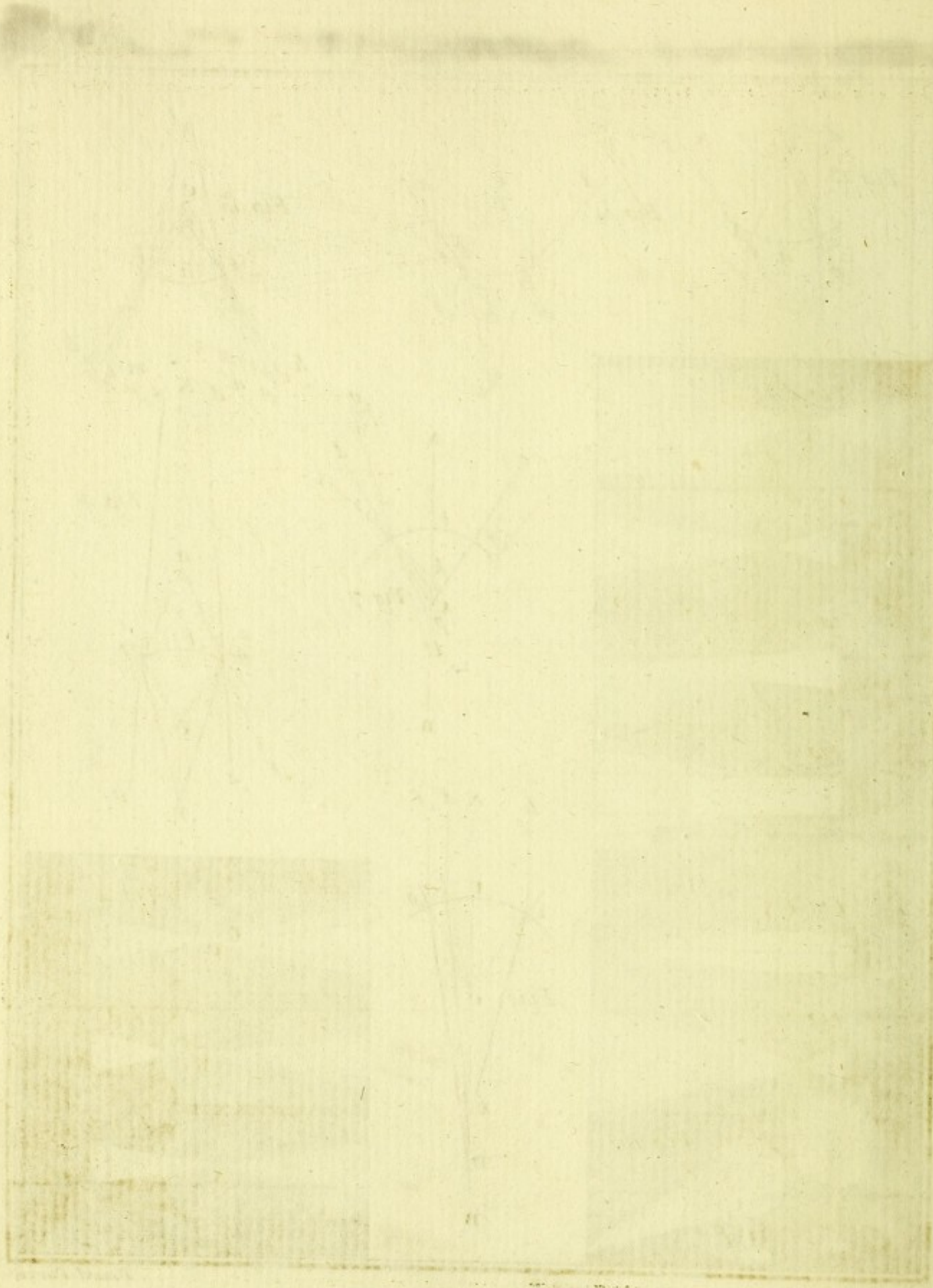


Fig. 1

Fig. 1.

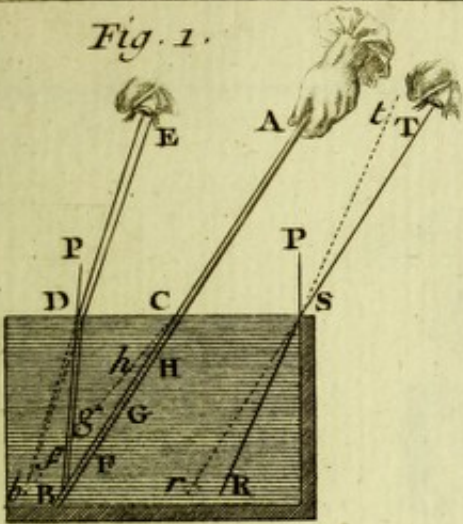


Fig. 2.

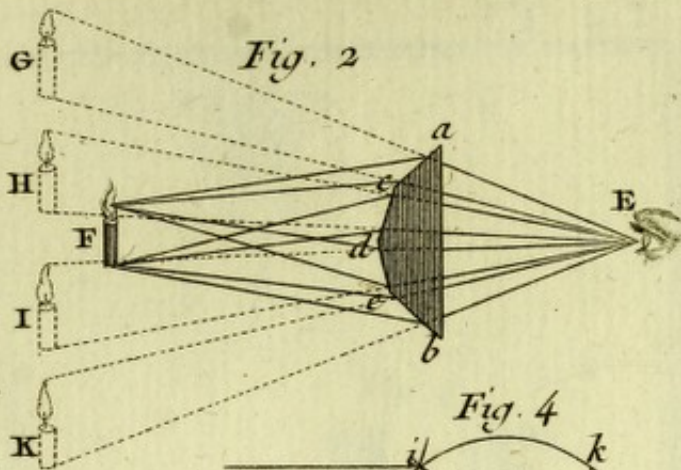


Fig. 4.

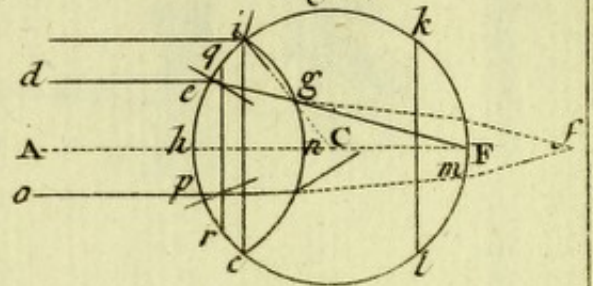


Fig. 3.

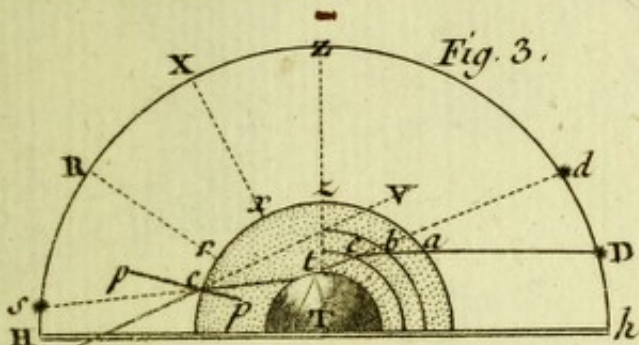


Fig. 6.

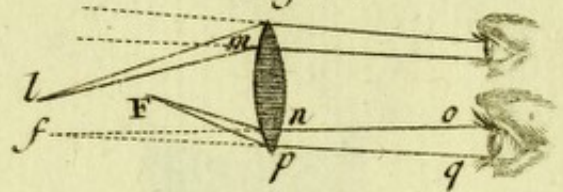


Fig. 5.

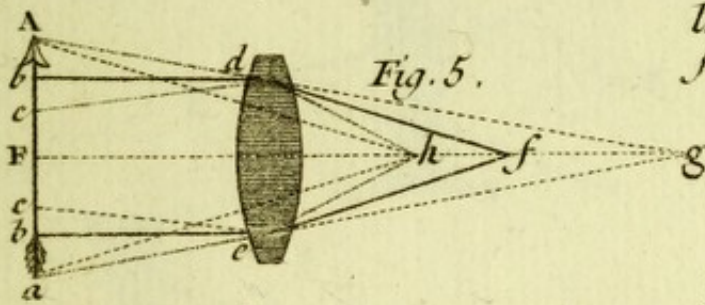


Fig. 7.

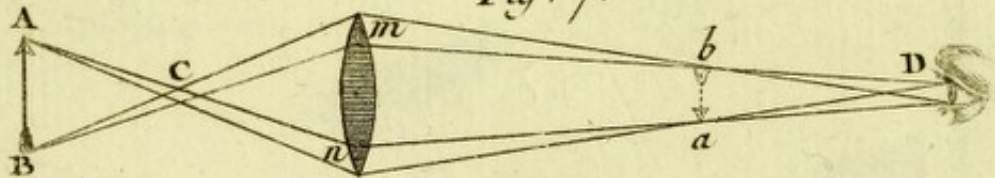


Fig. 8.

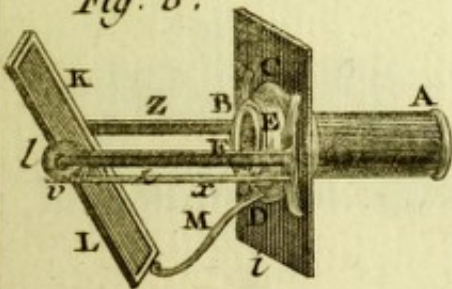


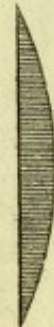
Fig. 9.



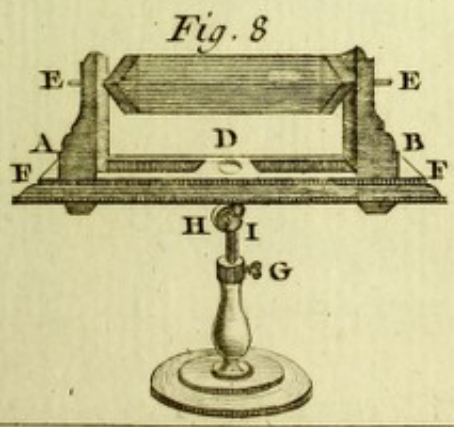
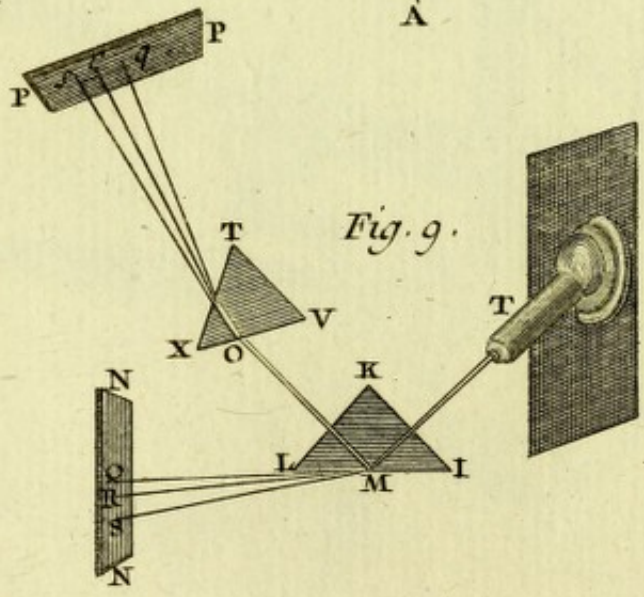
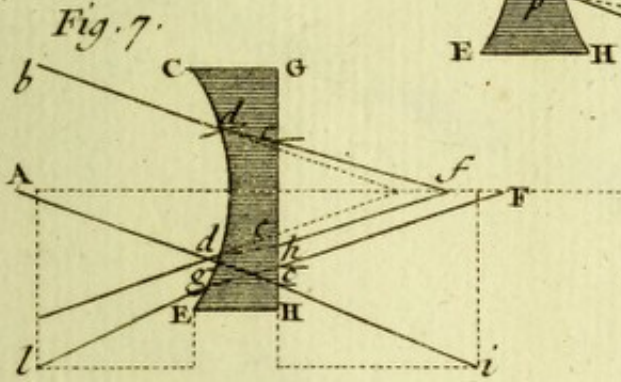
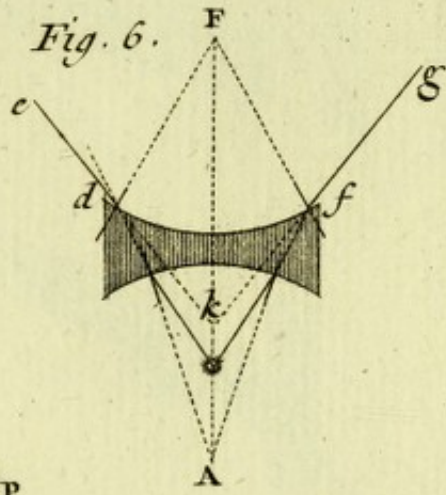
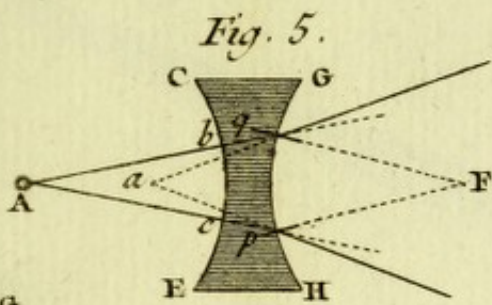
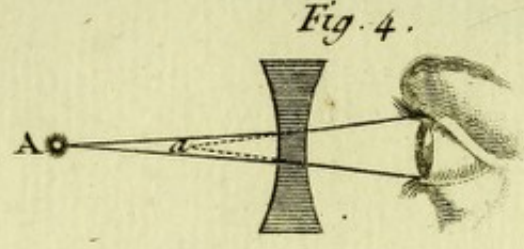
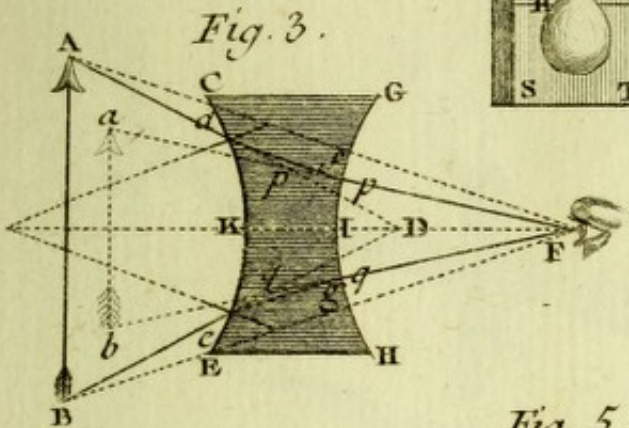
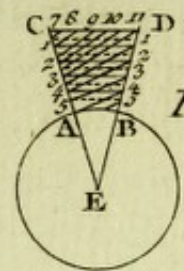
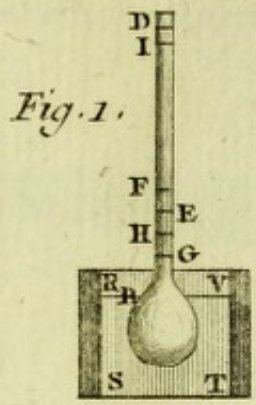
Fig. 10.

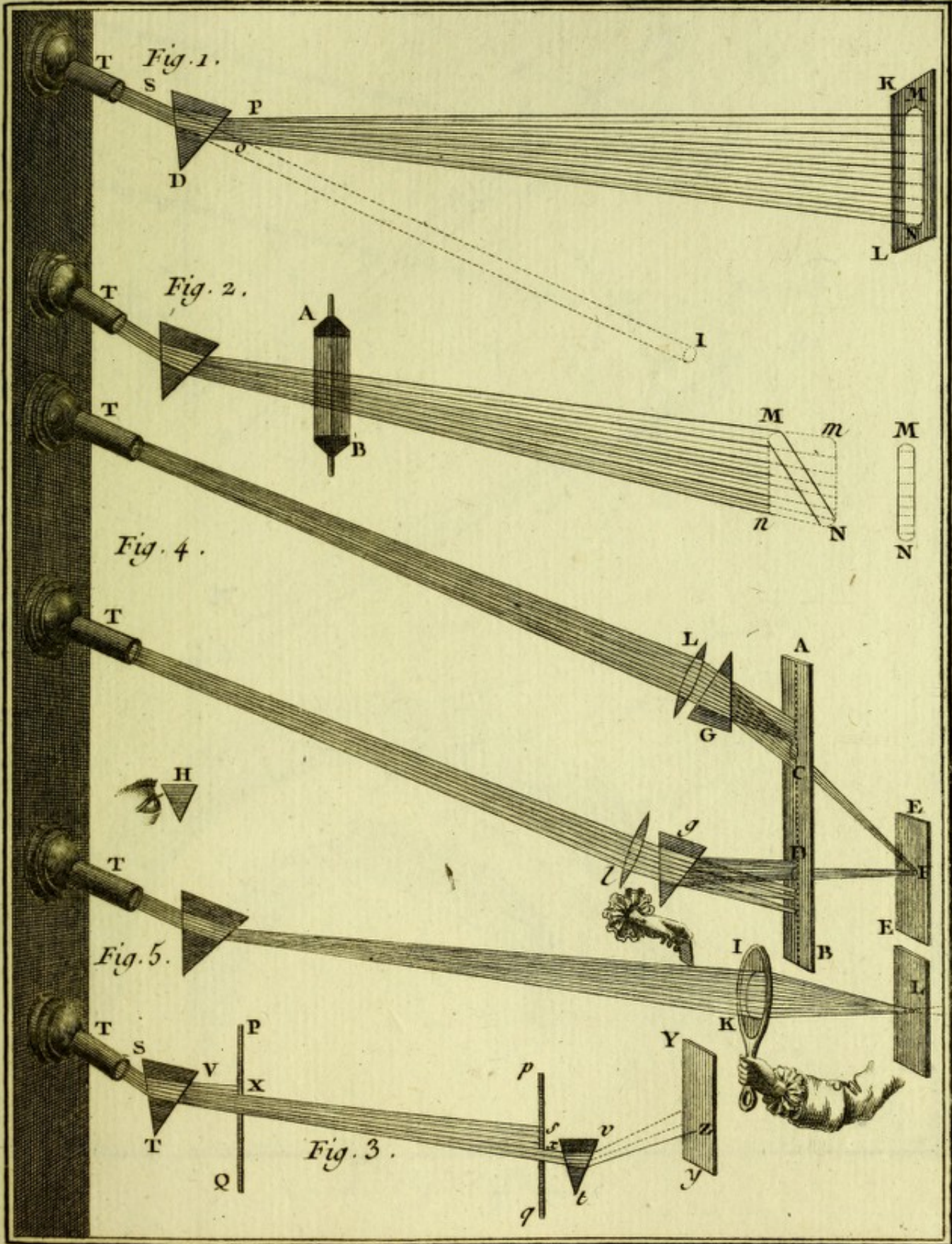


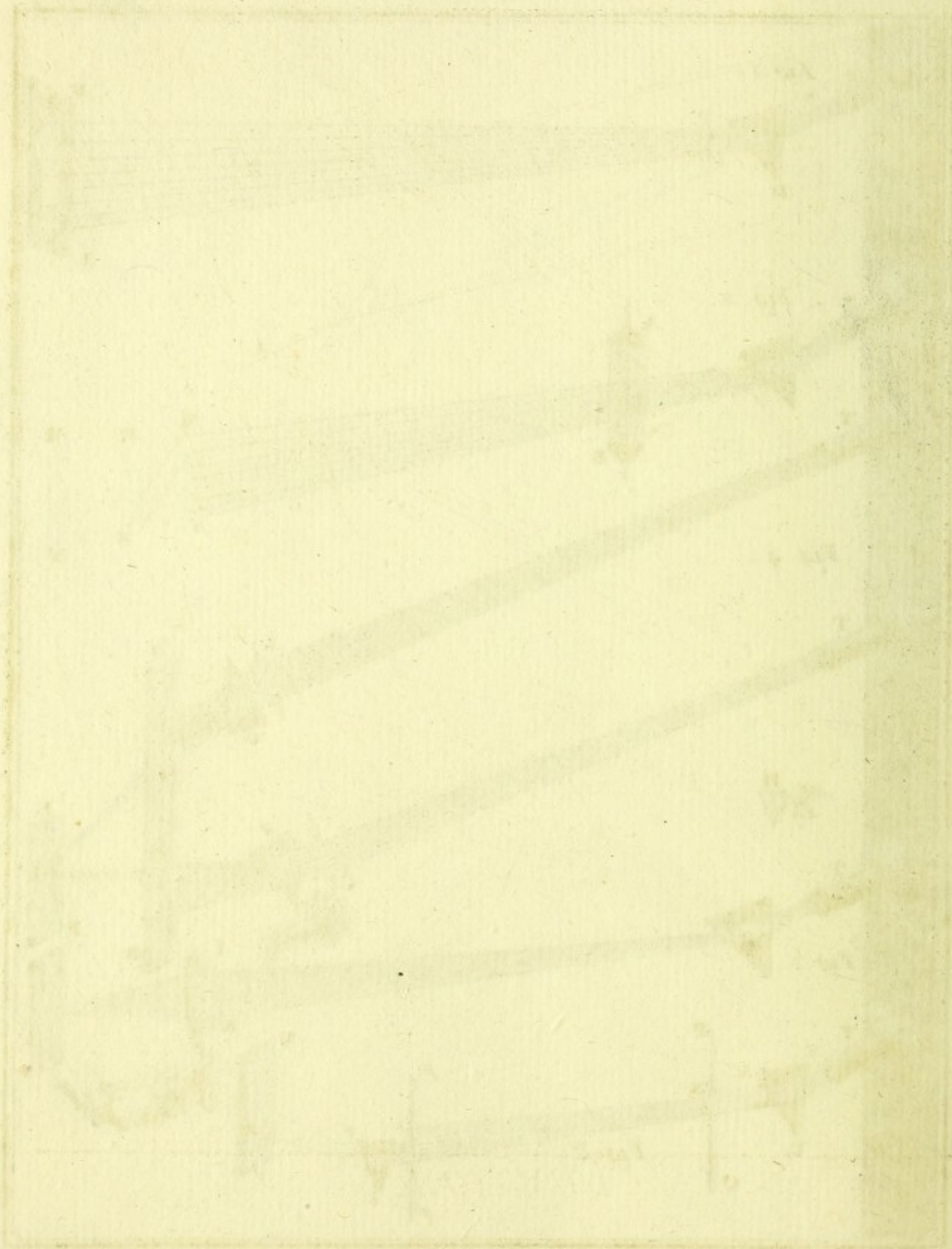
Fig. 11.



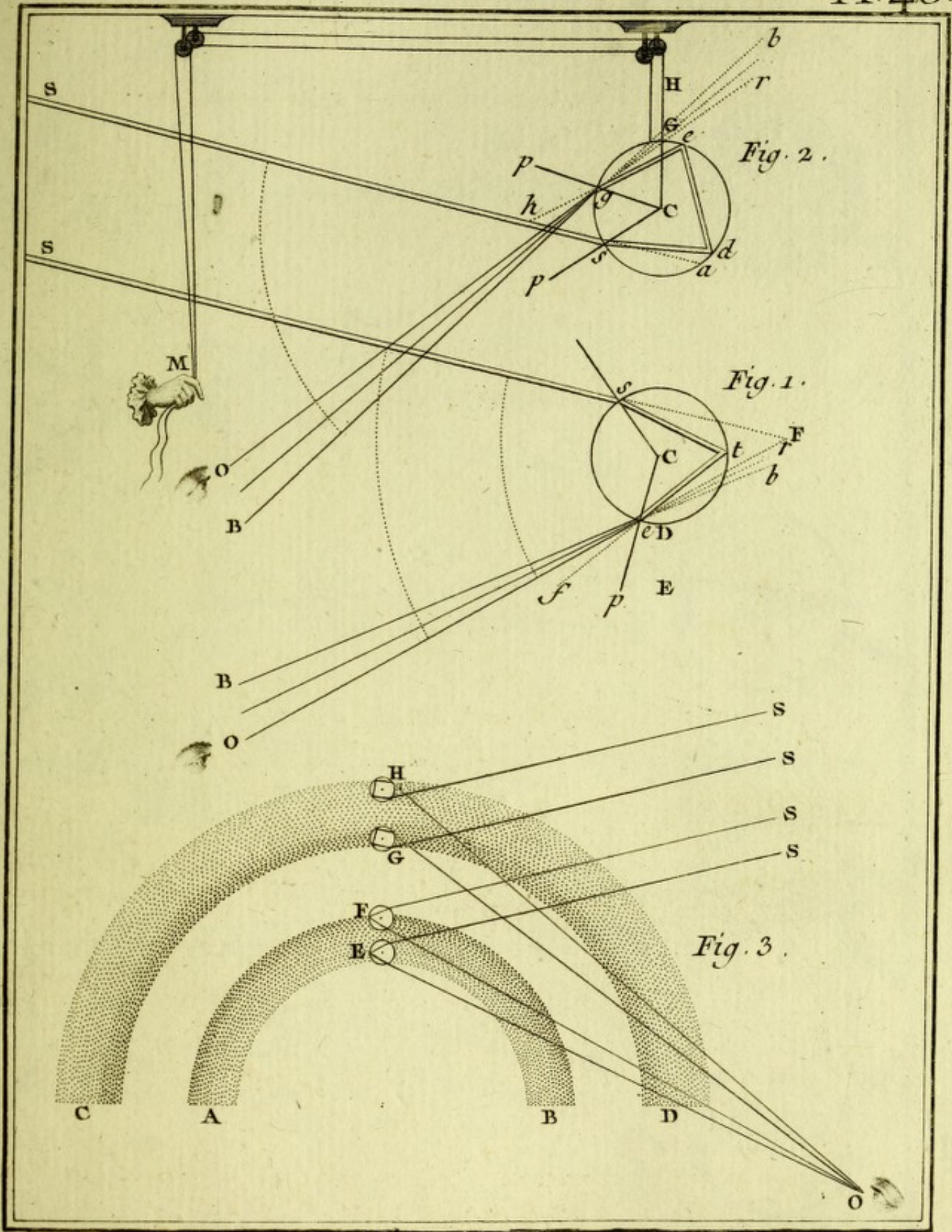
Benard Dorexet.



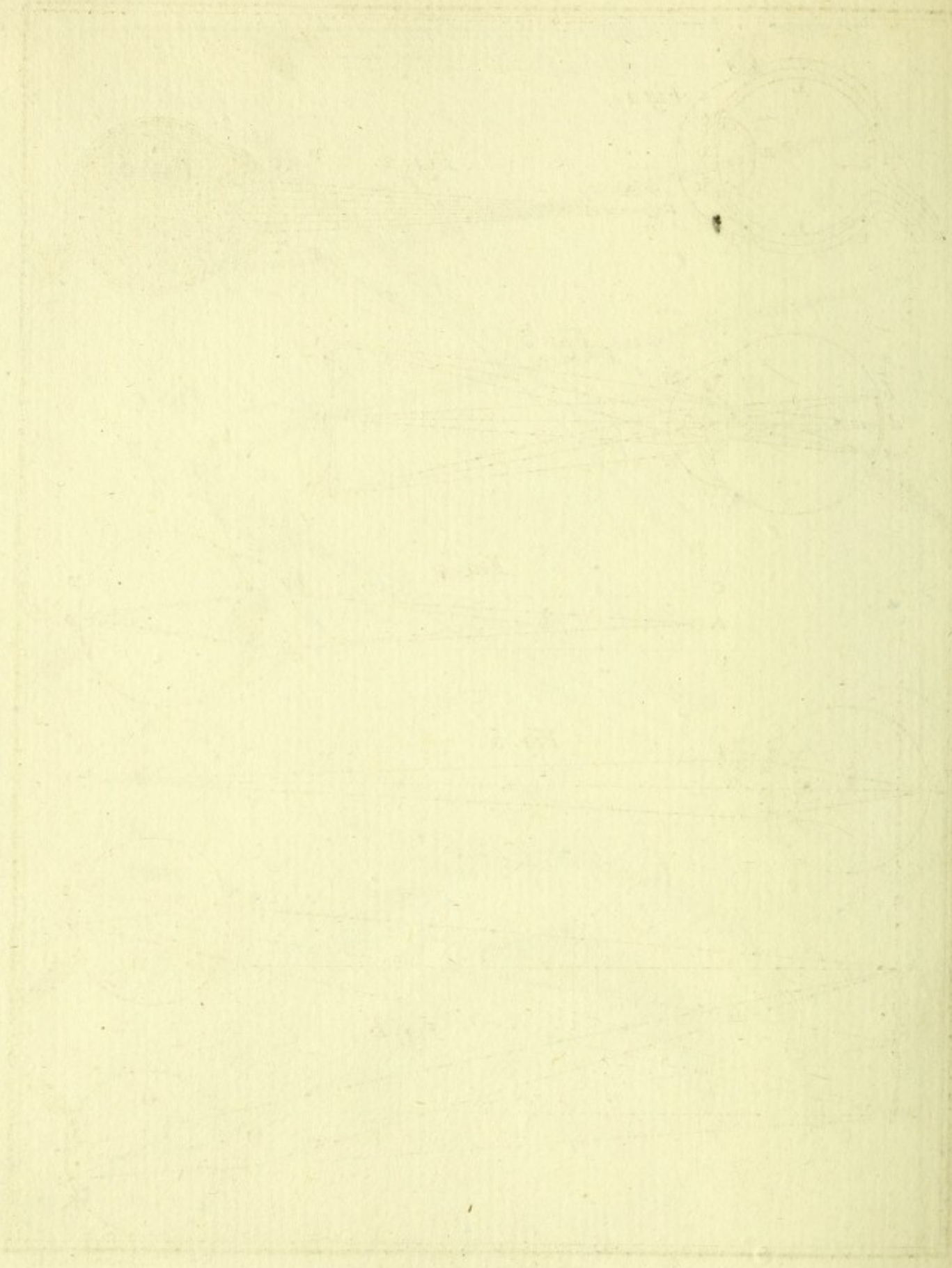


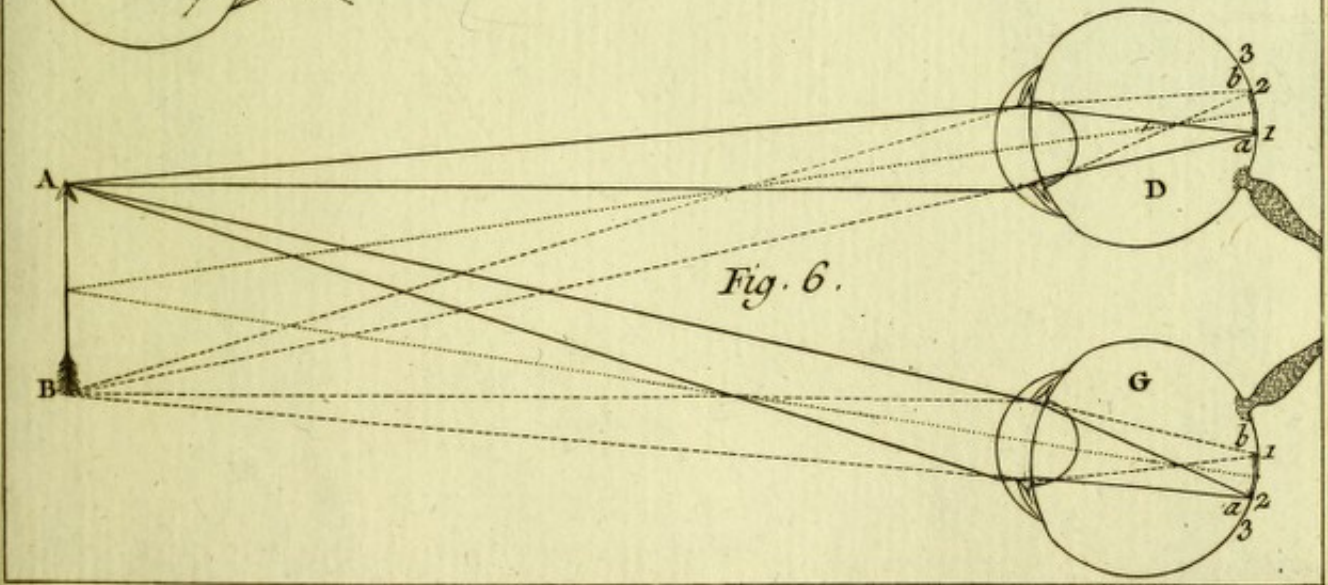
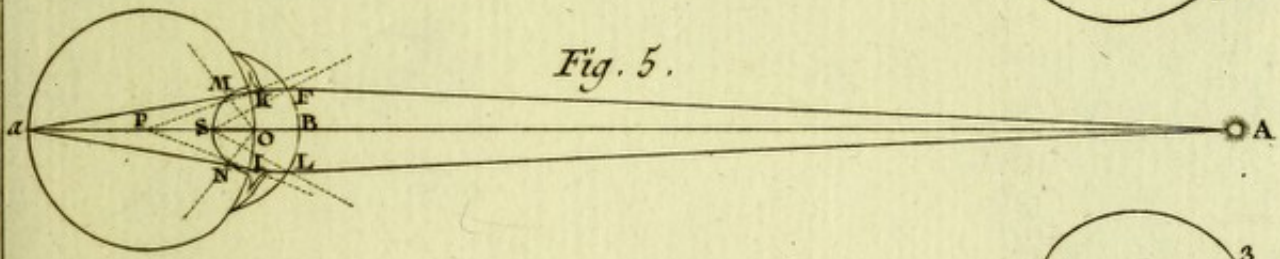
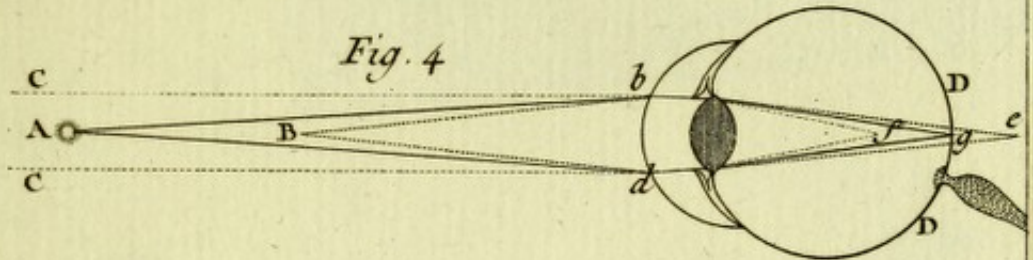
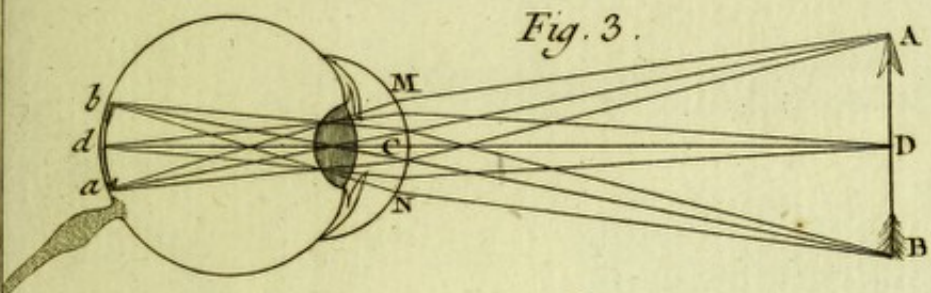
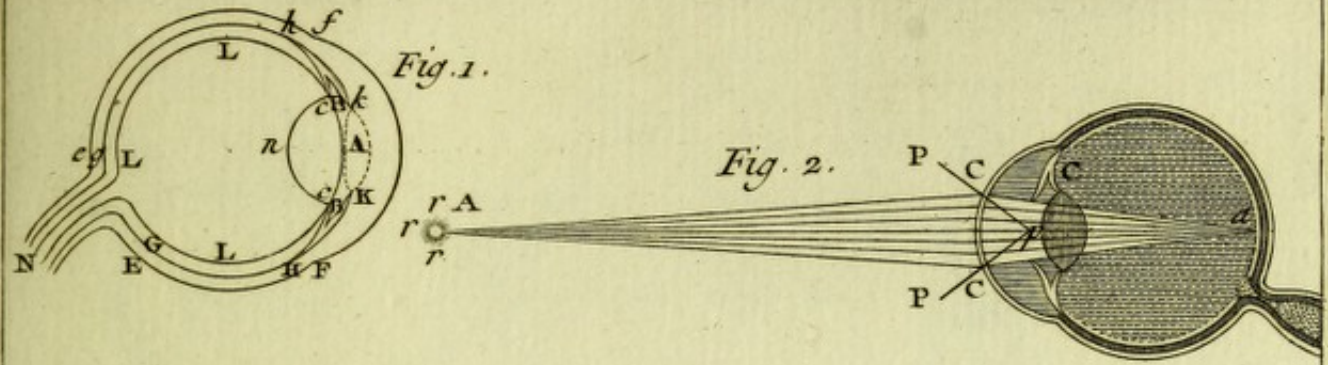


Account of the ...



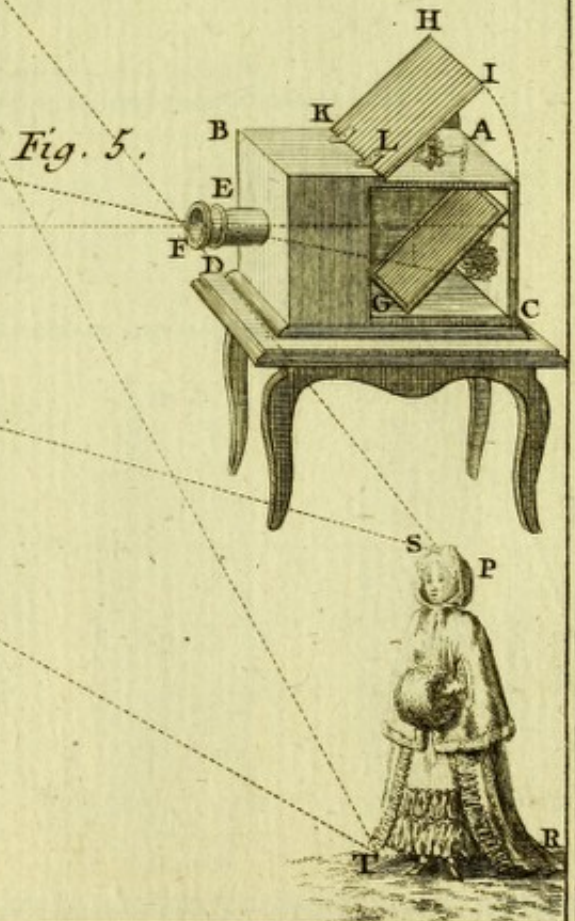
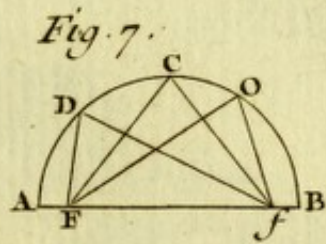
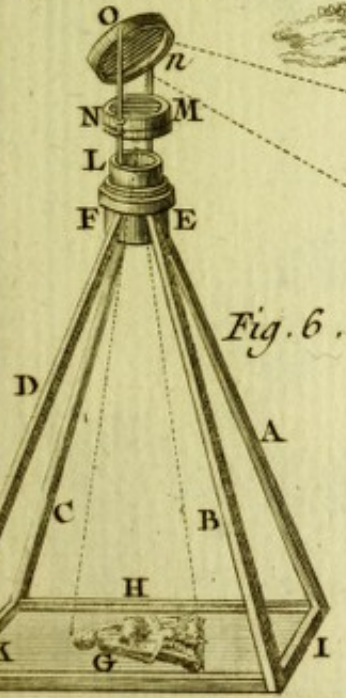
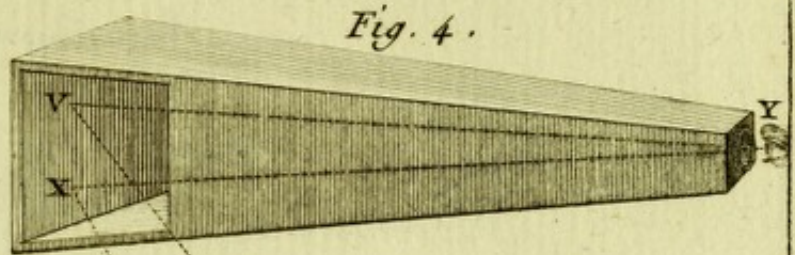
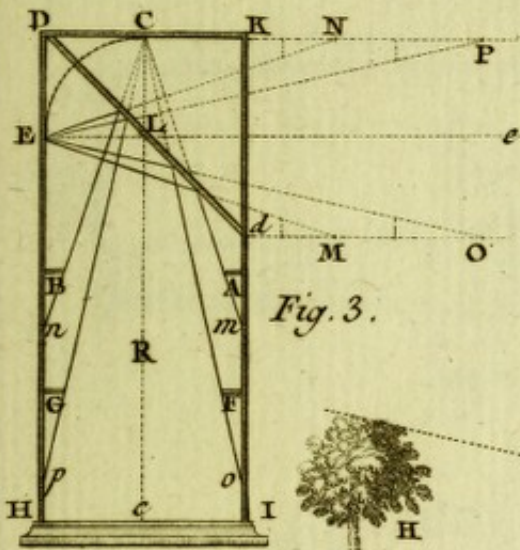
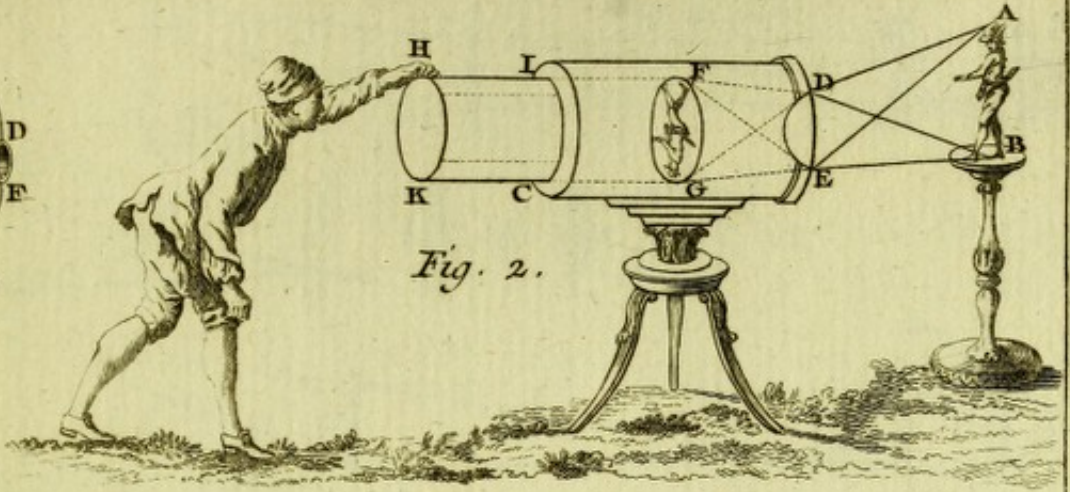
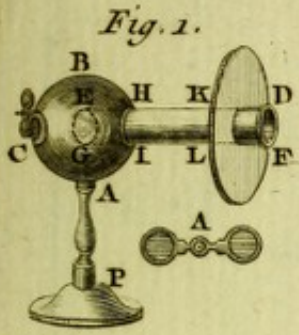
Physique.





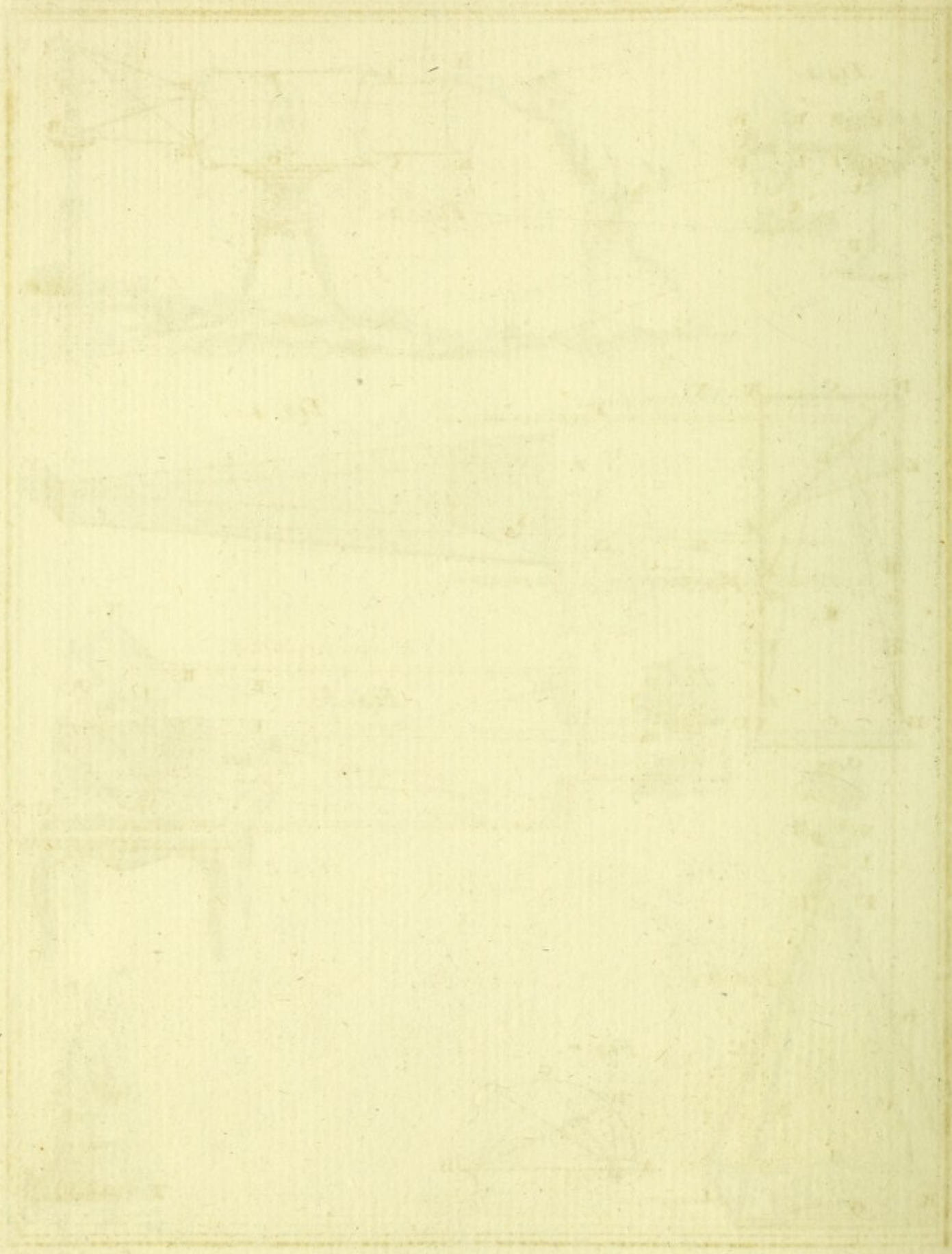
Physique.

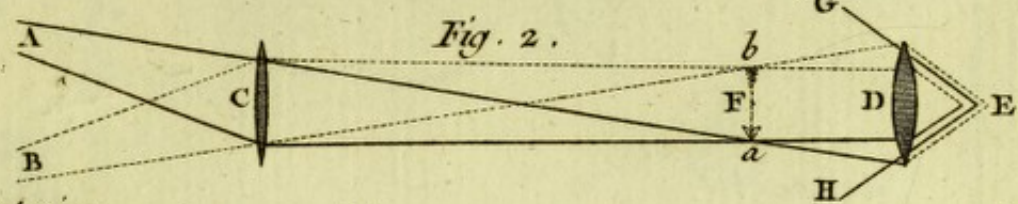
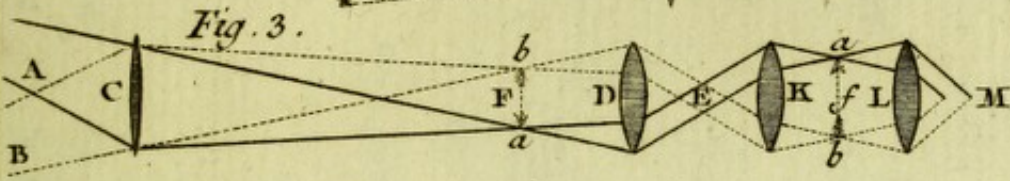
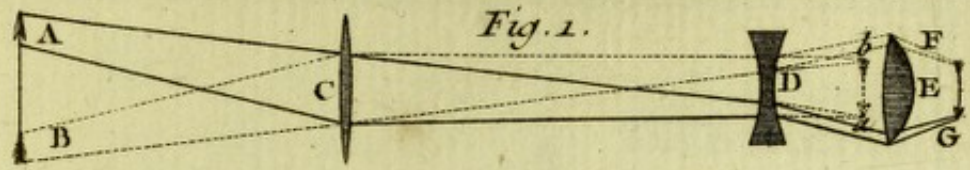
Benard Duxcit.



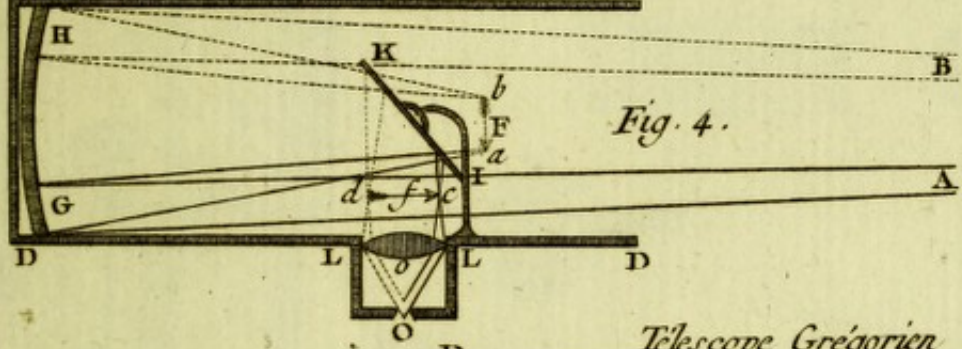
Physique.

Benard Dixxit.





Télescope Newtonien.



Télescope Grégorien

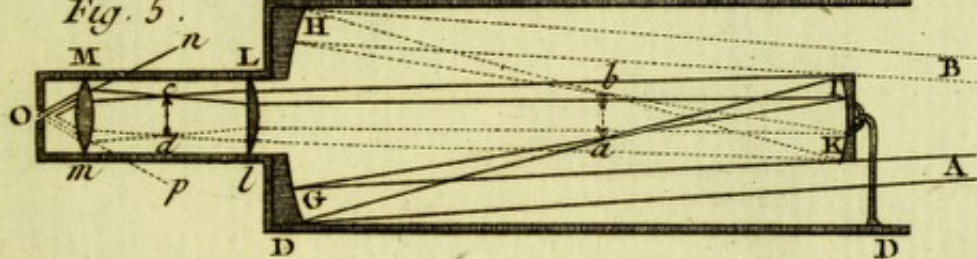


Fig. 6.

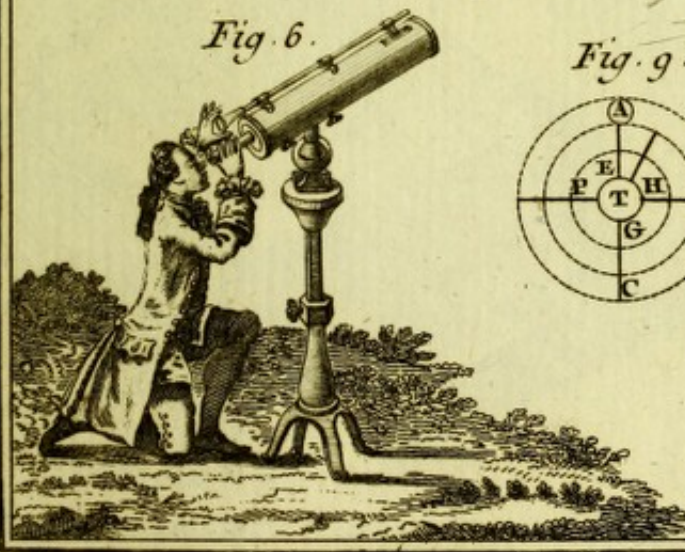


Fig. 9.

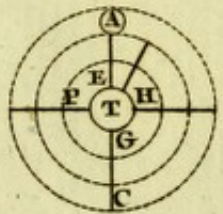


Fig. 8.

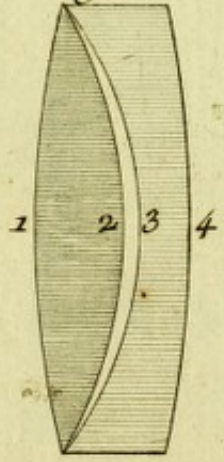
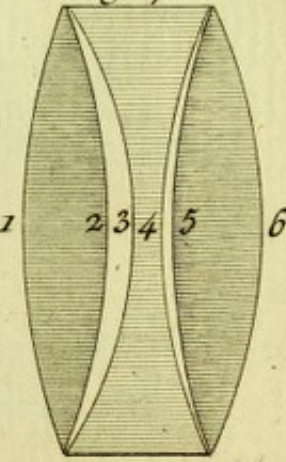
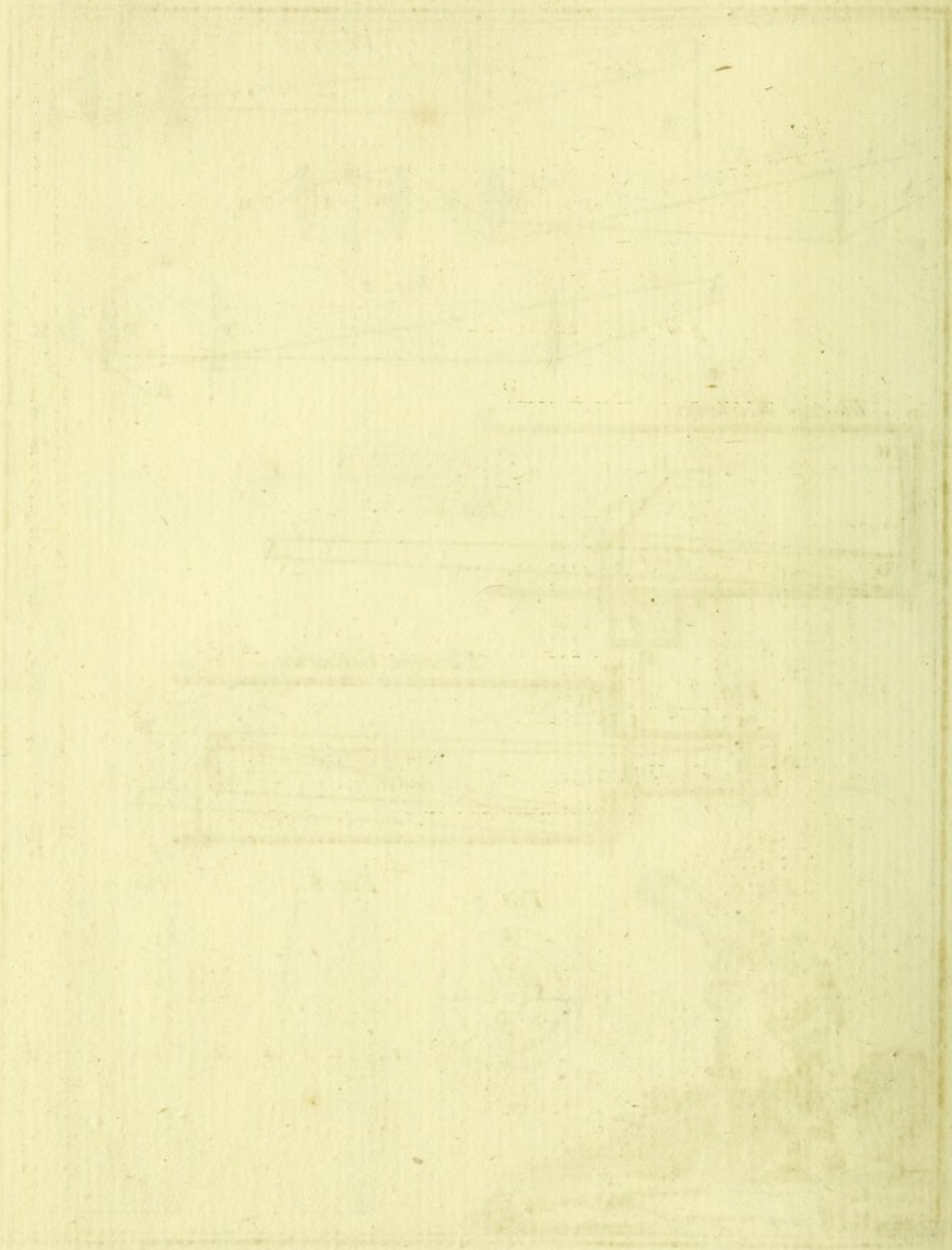
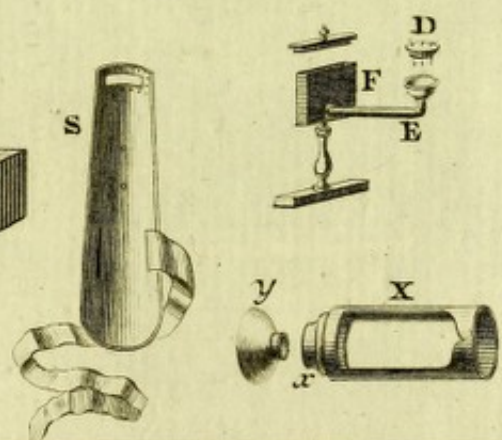
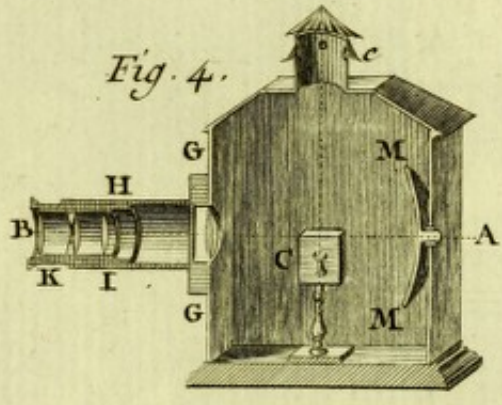
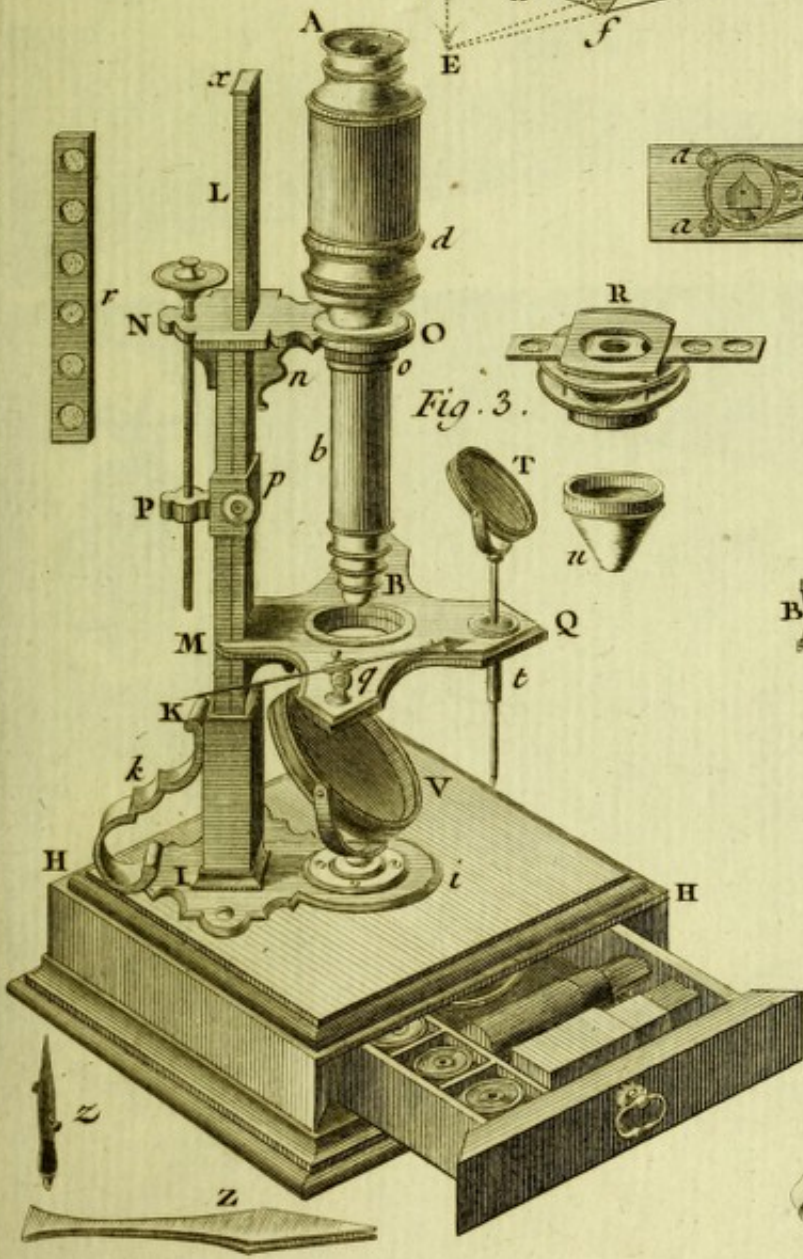
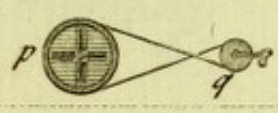
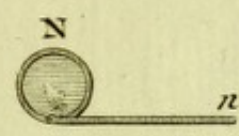
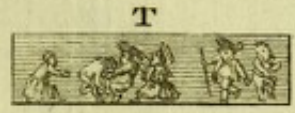
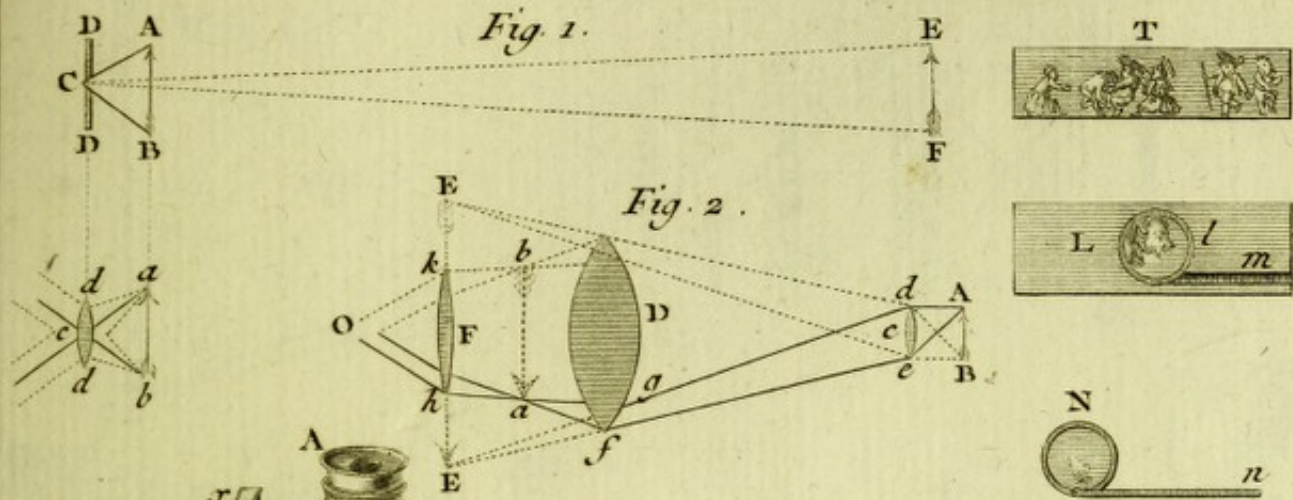


Fig. 7.



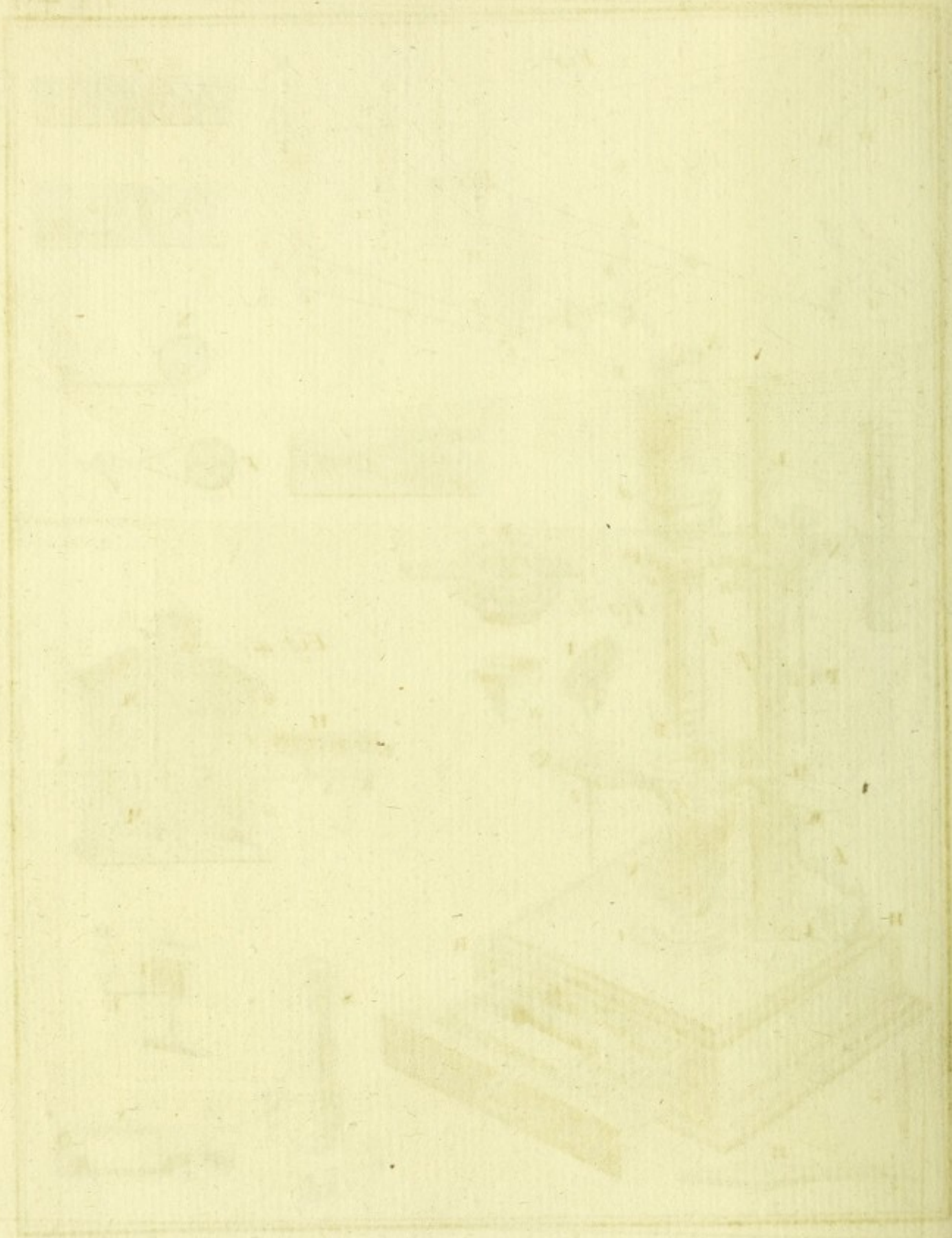


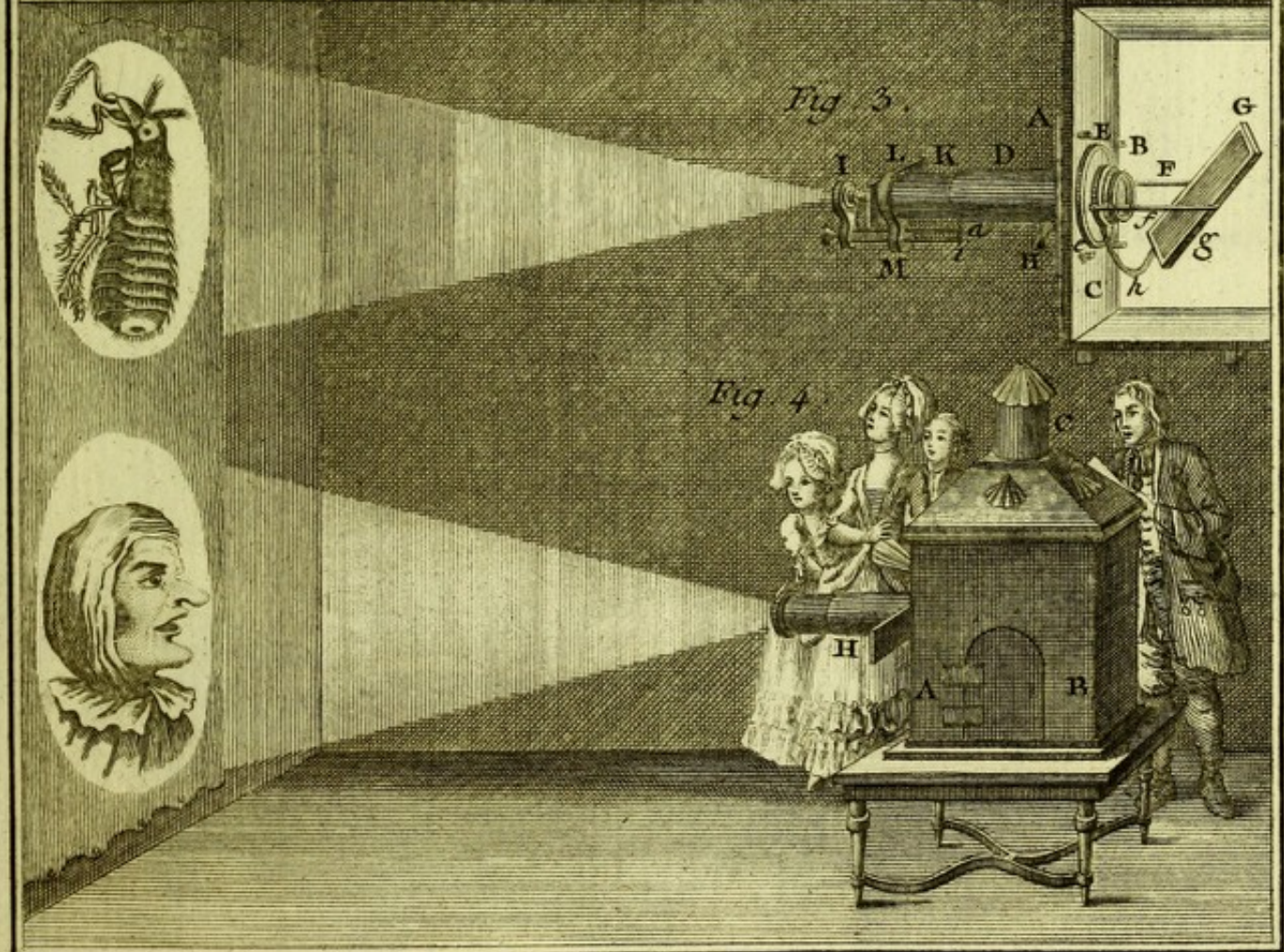
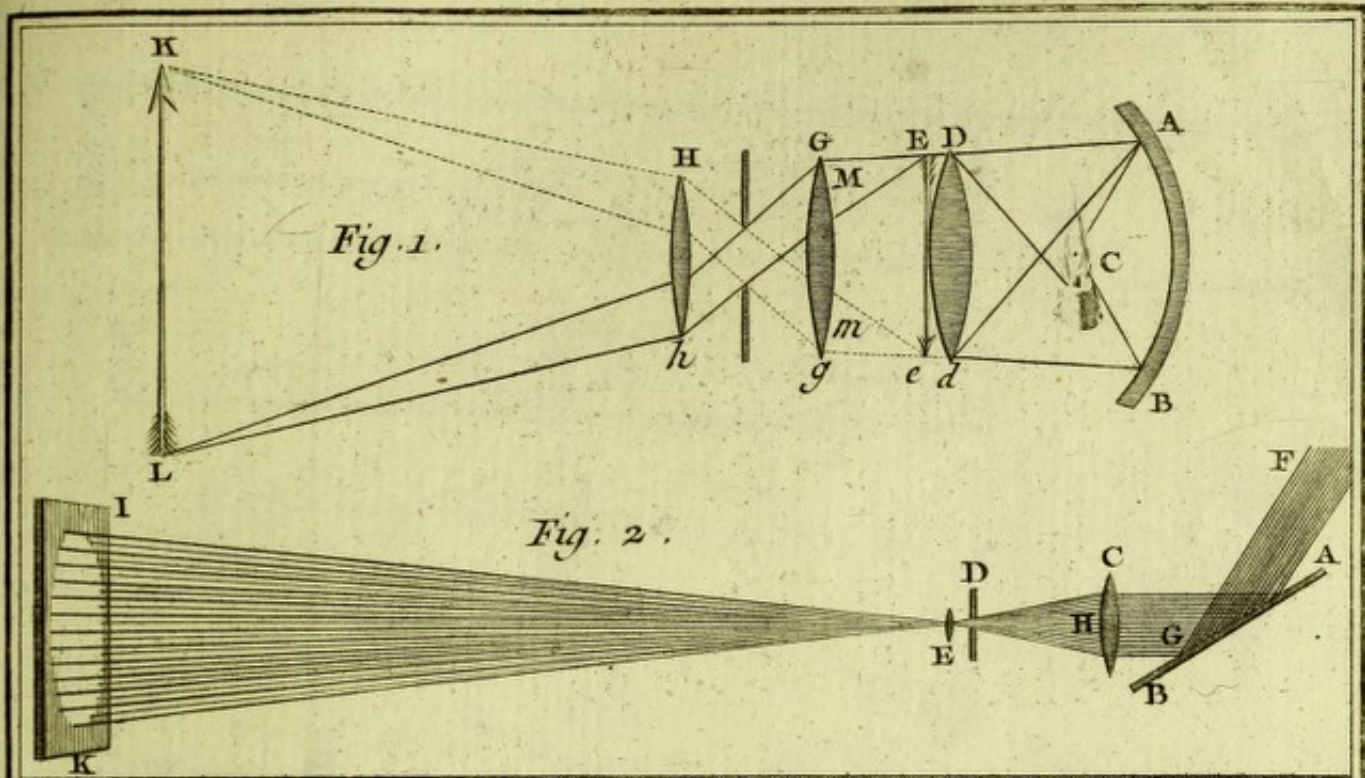


Physique.

Bonard. Dirigit.

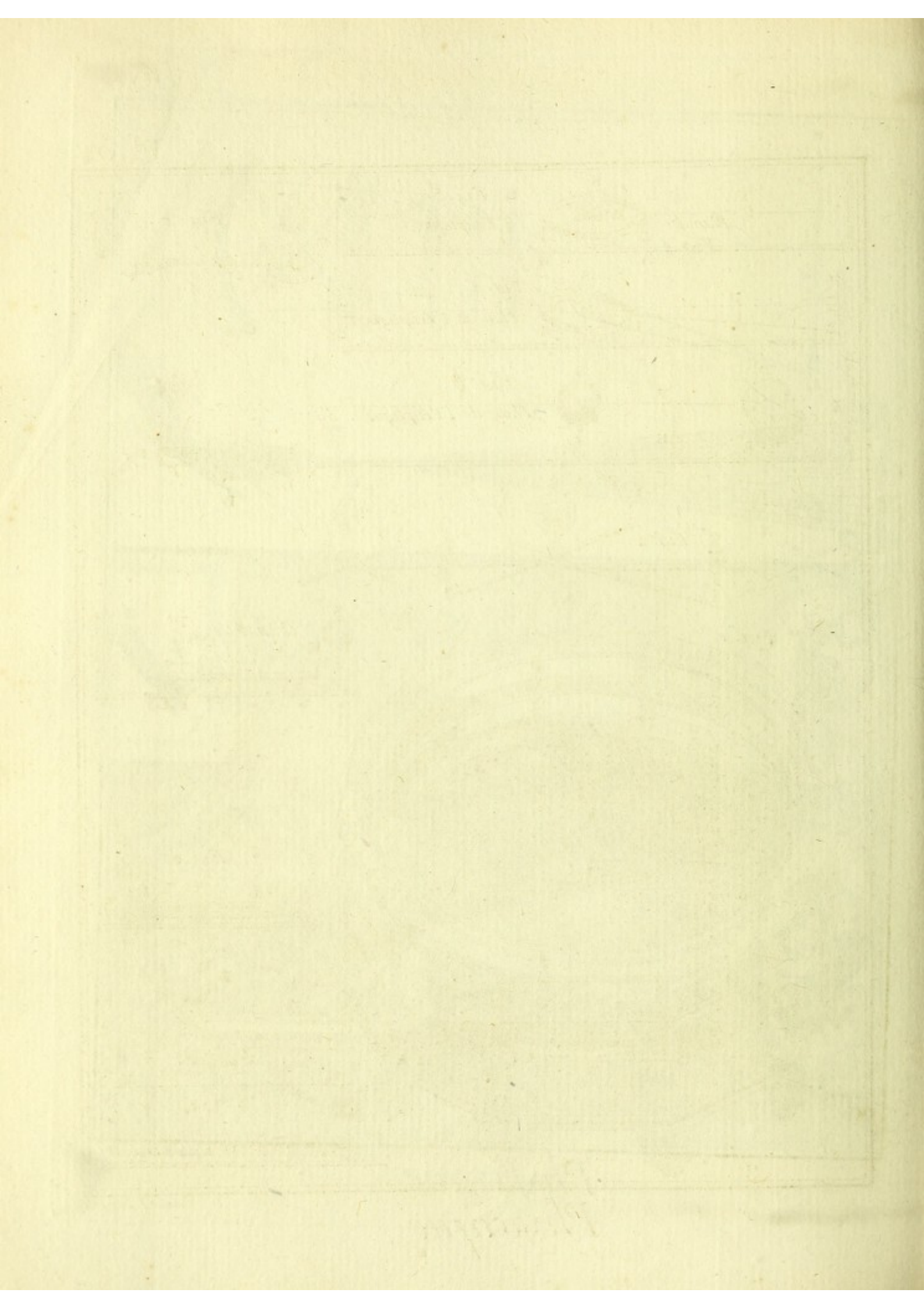
171

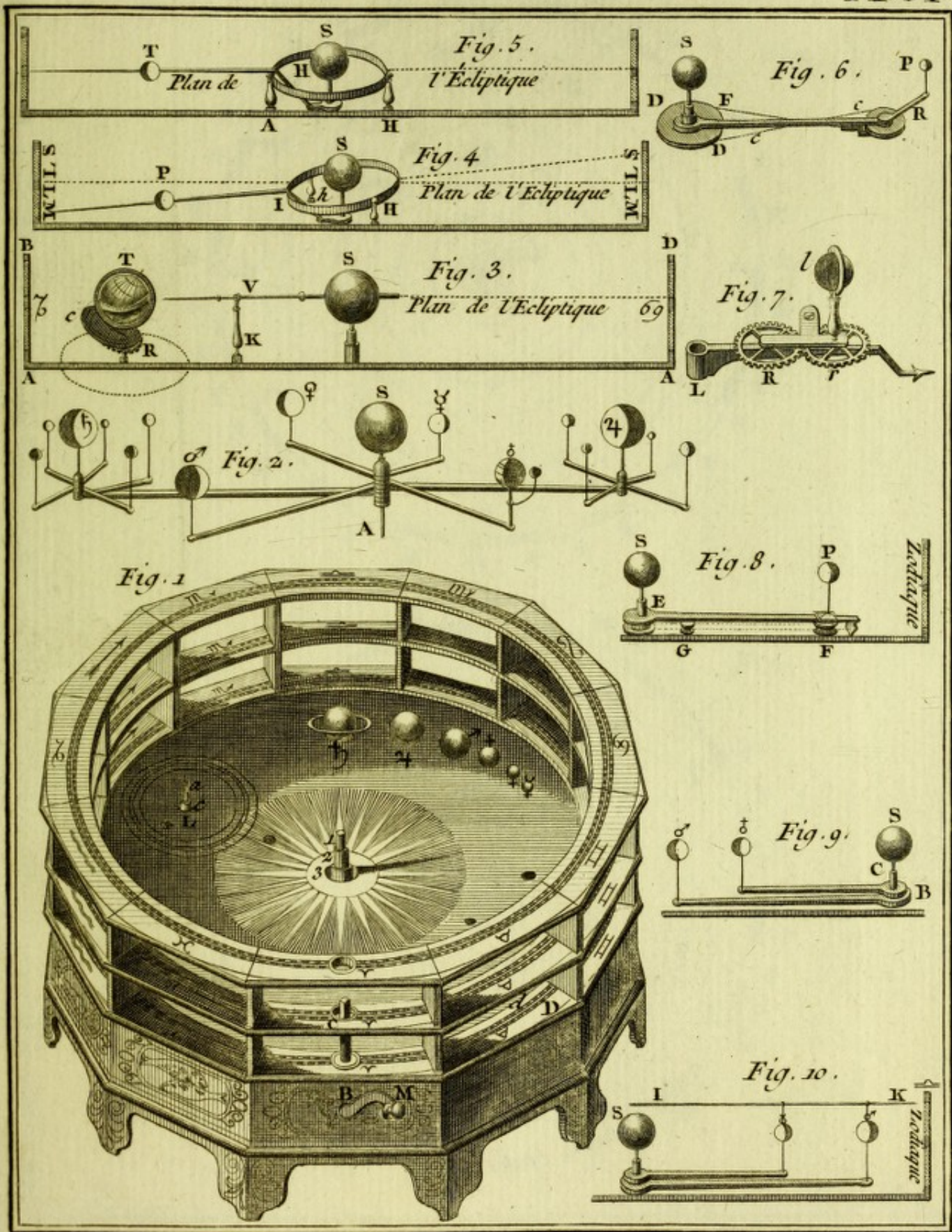




Physique.

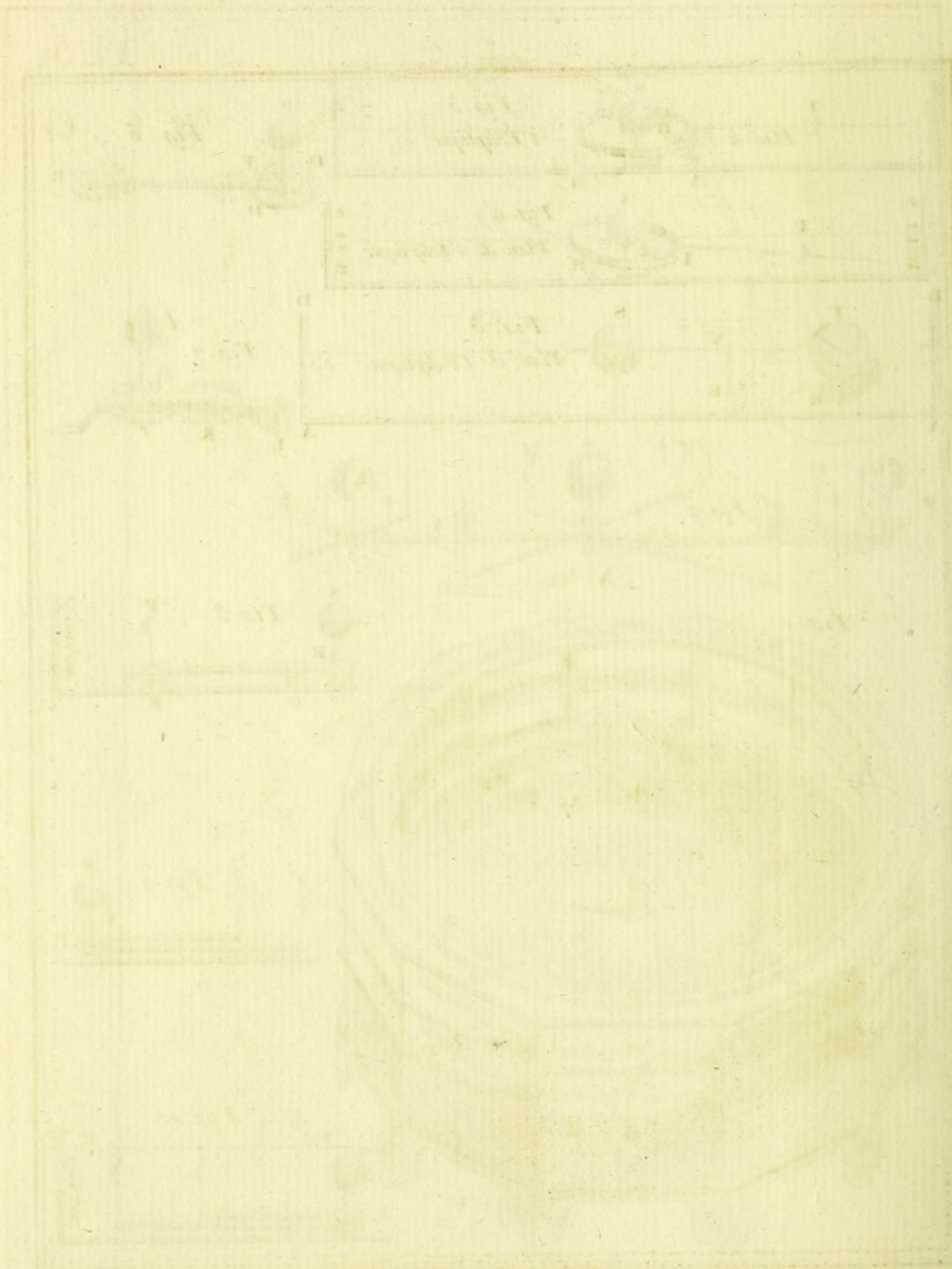
Benard Duxxit.

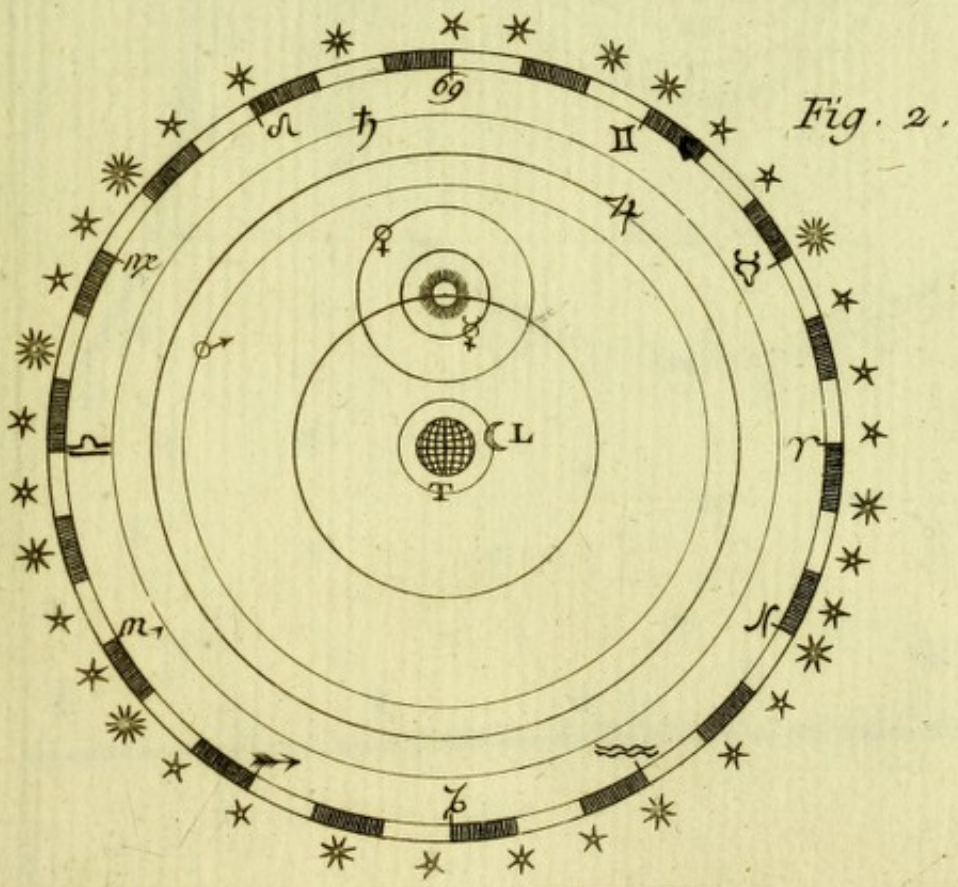
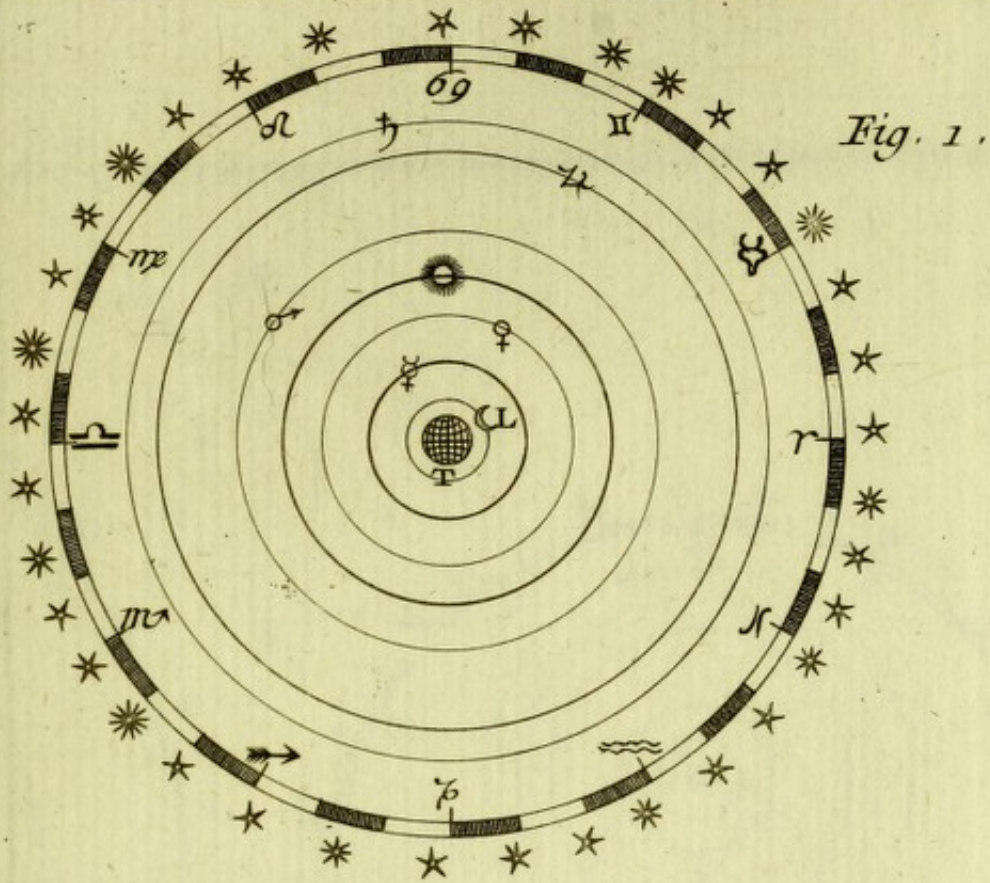




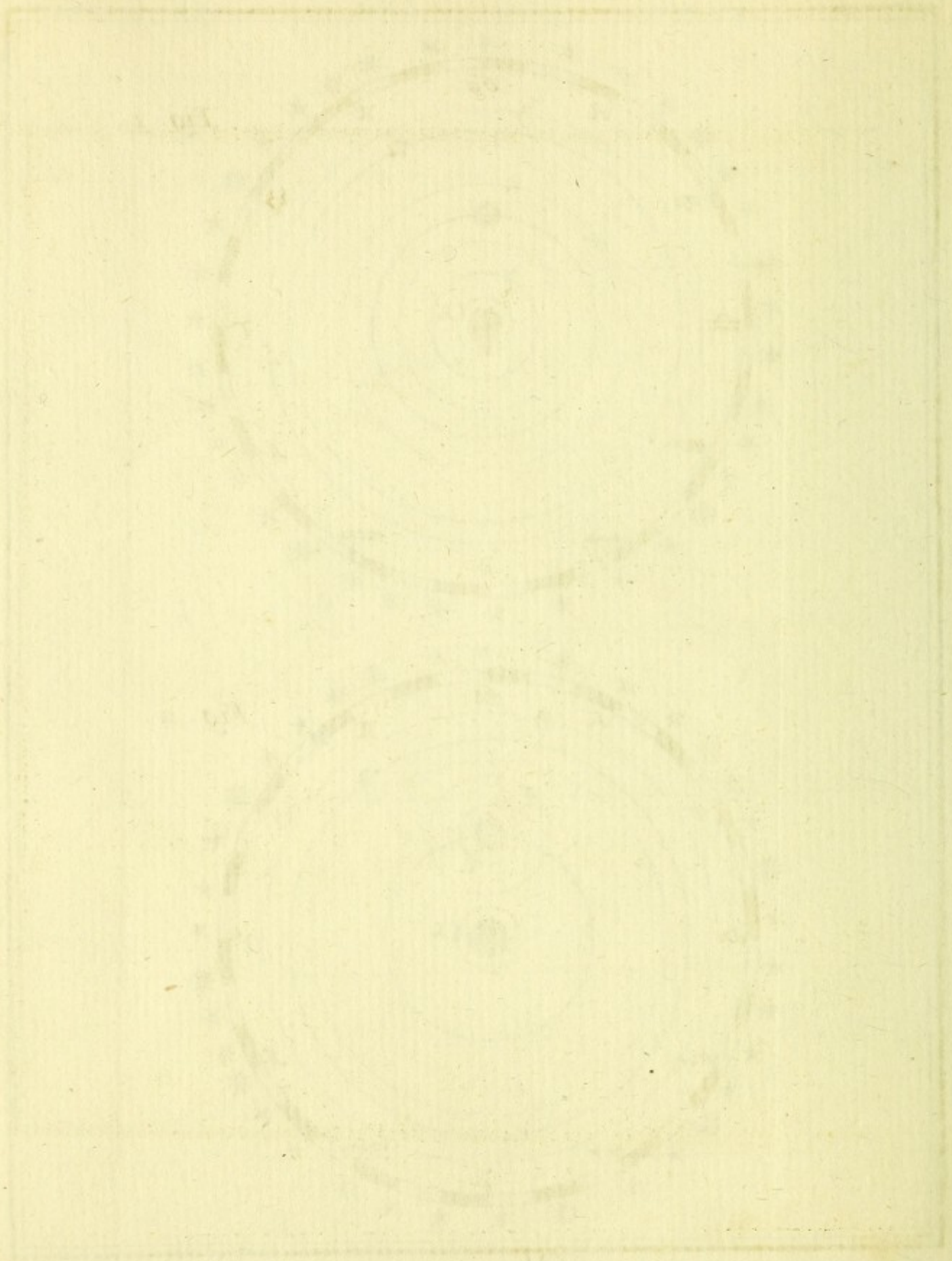
Physique.

Bernard Diveret.





Physique.



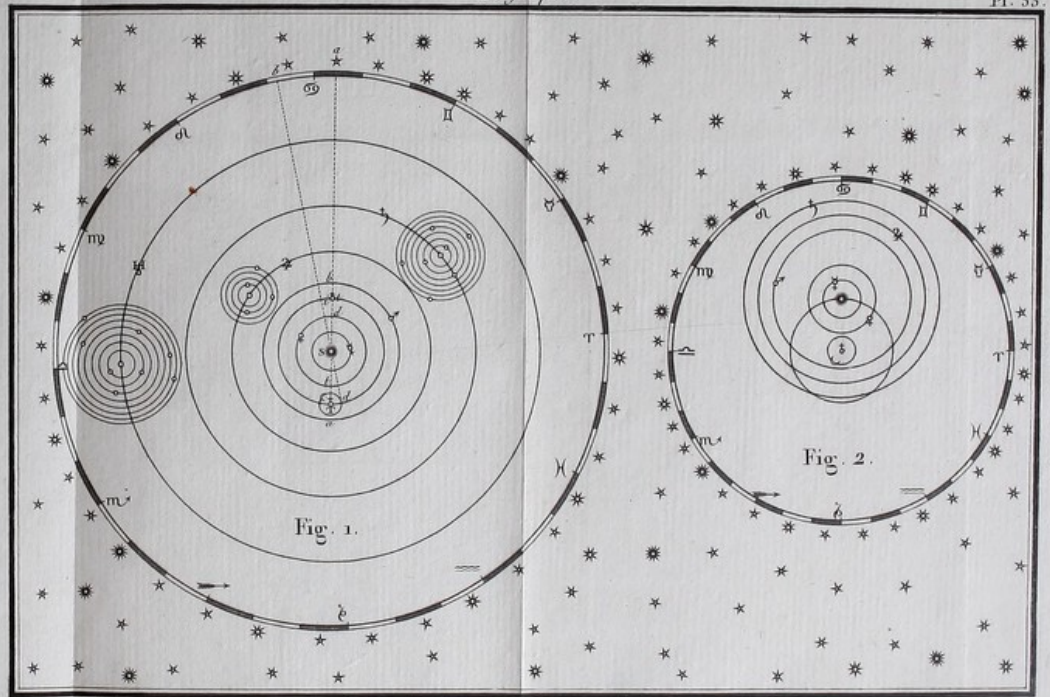




Fig. 1.

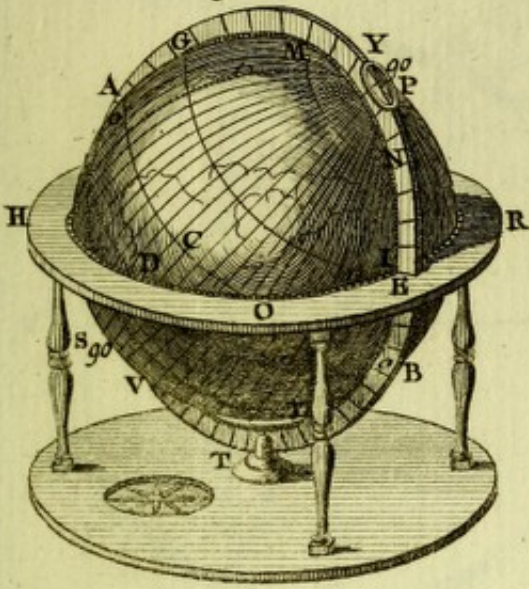


Fig. 2.

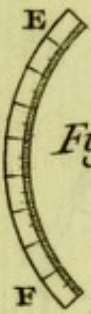
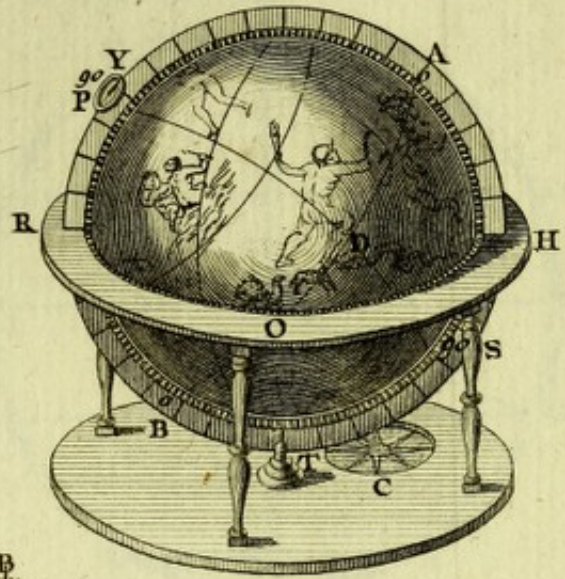


Fig. 3.

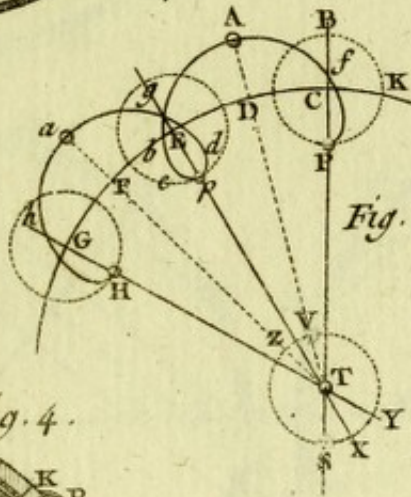


Fig. 6.

Fig. 4.

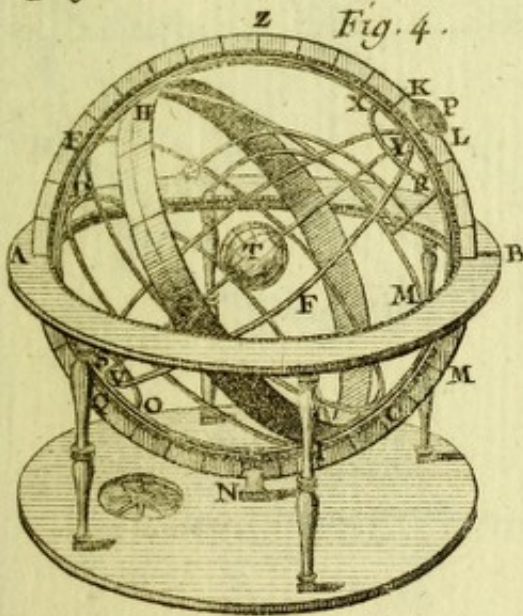
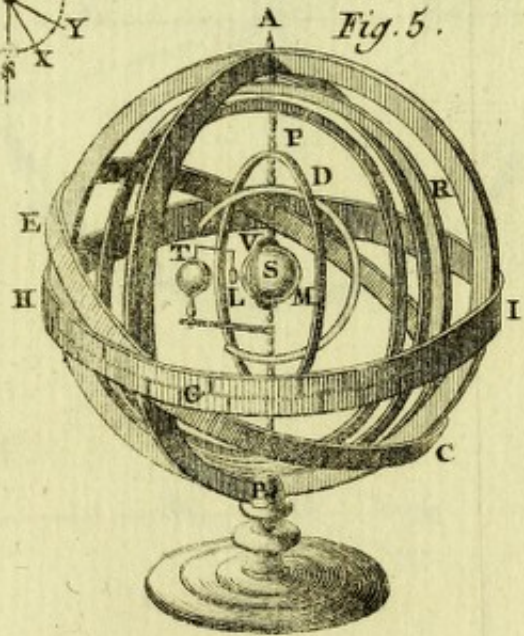


Fig. 5.





Faint, illegible text or a signature at the bottom center of the page.

Fig. 1.

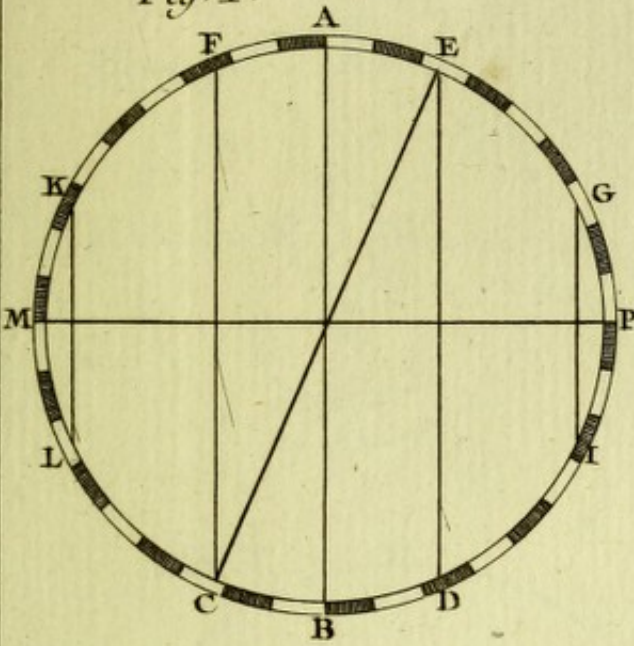


Fig. 4.

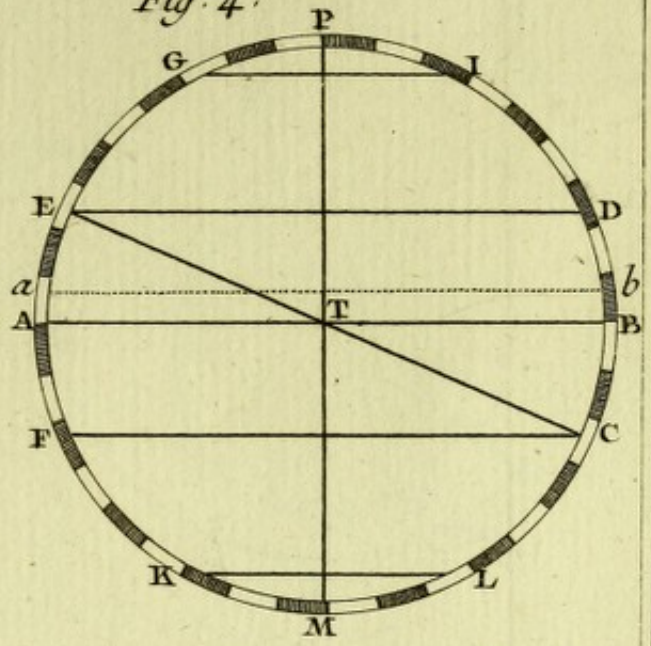


Fig. 2.

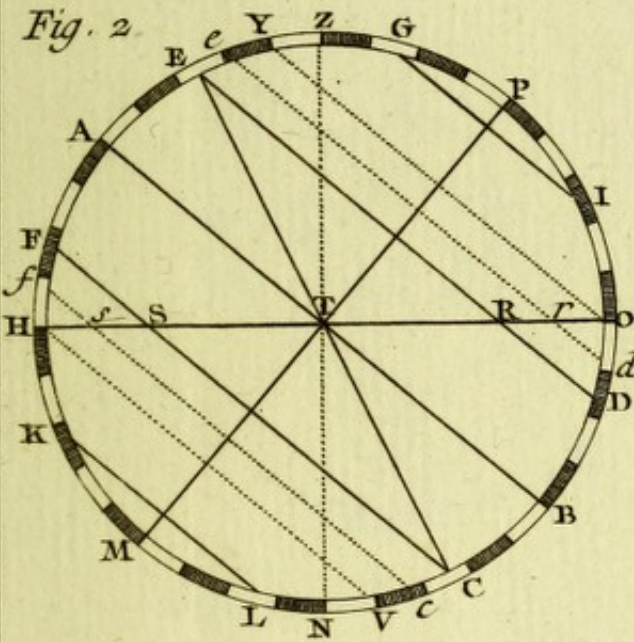


Fig. 3.

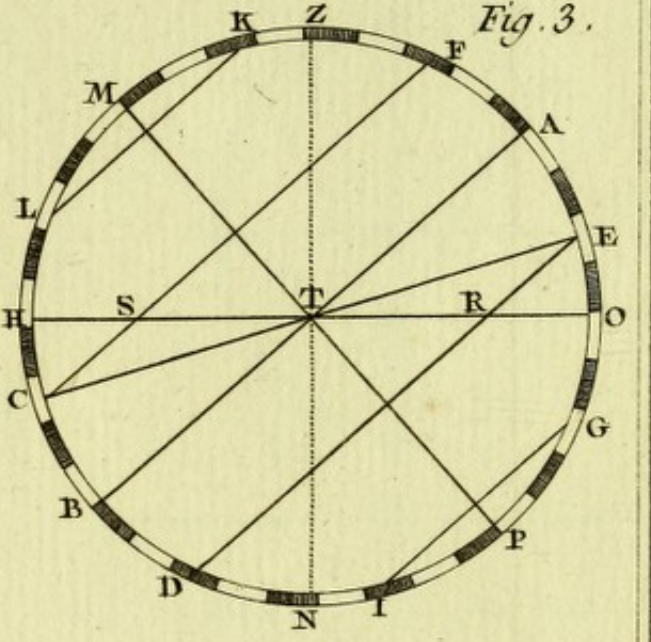
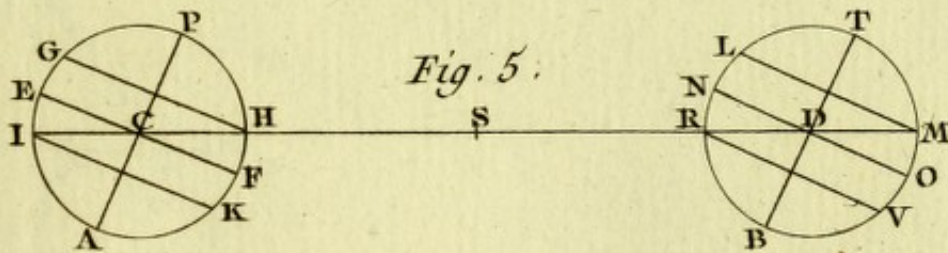
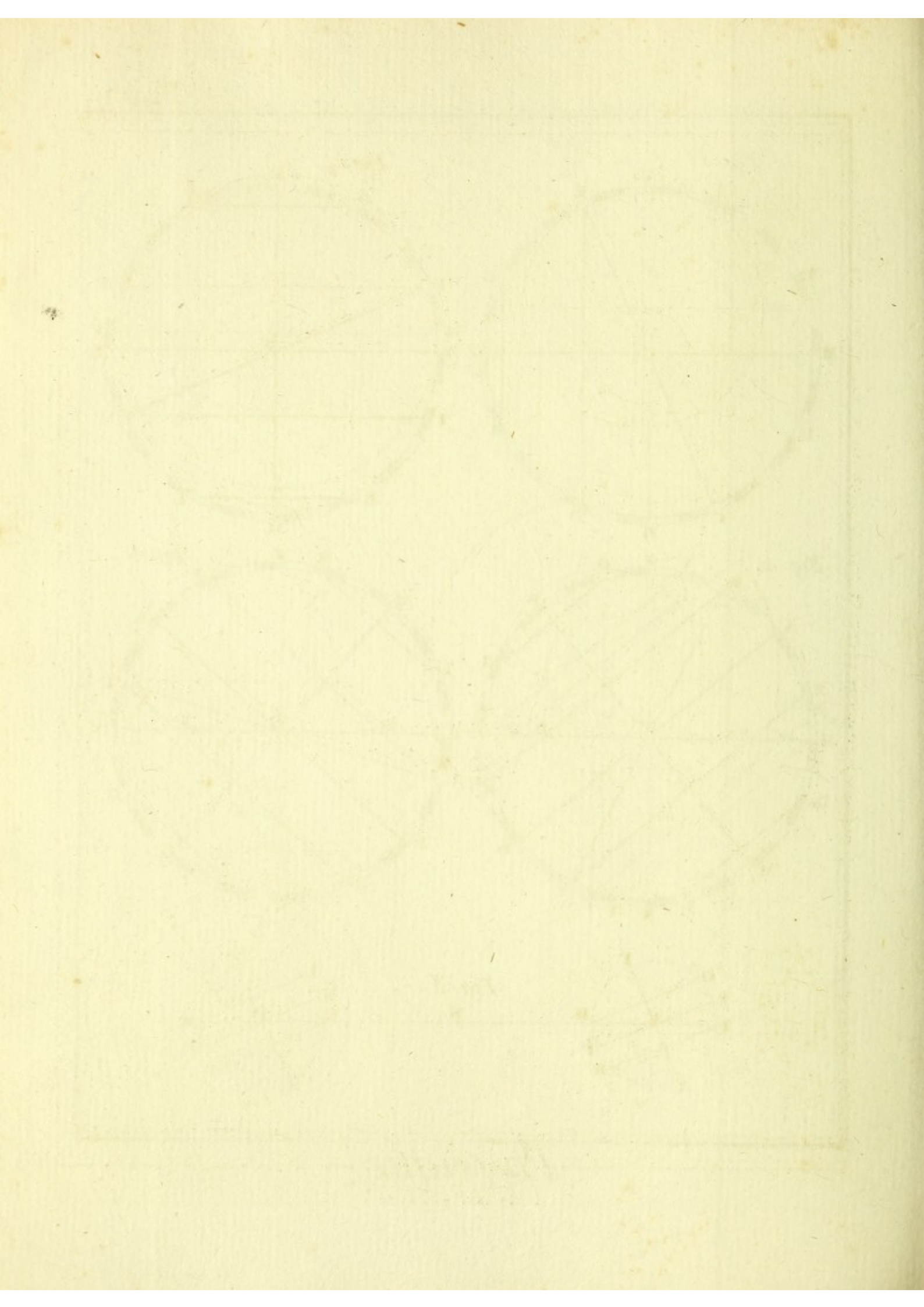
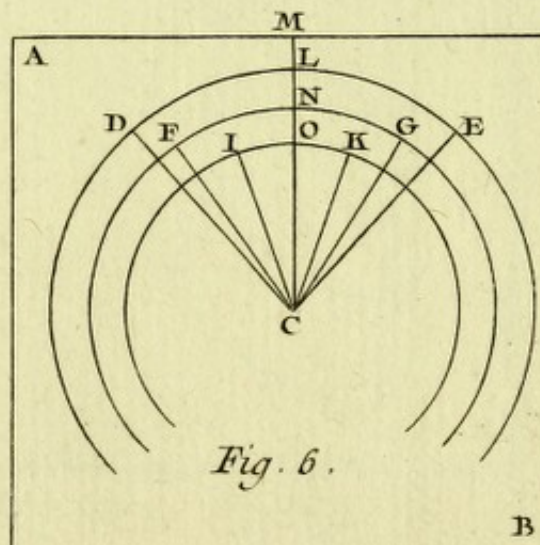
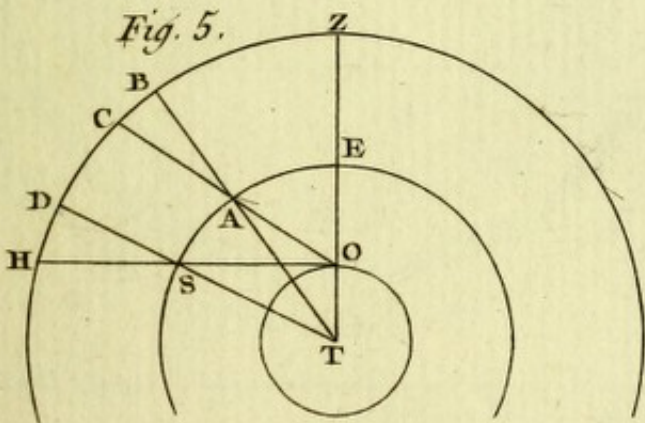
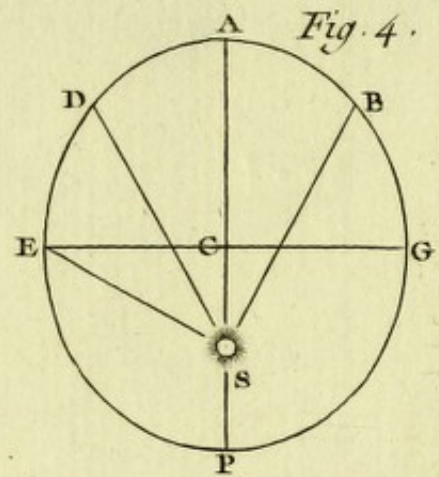
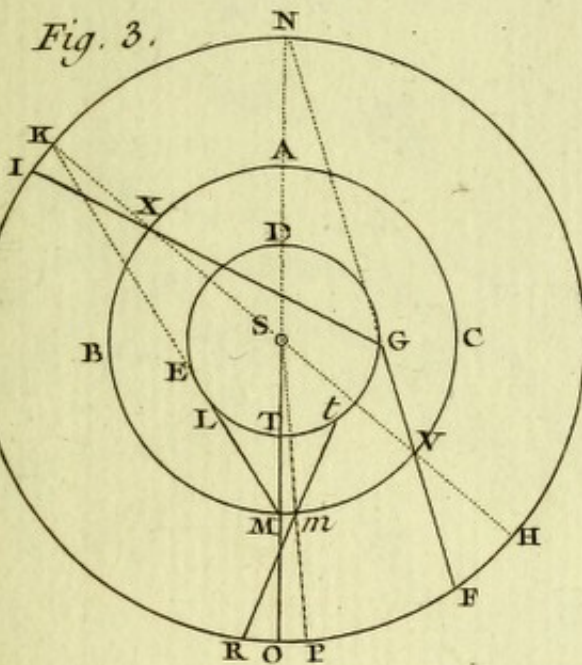
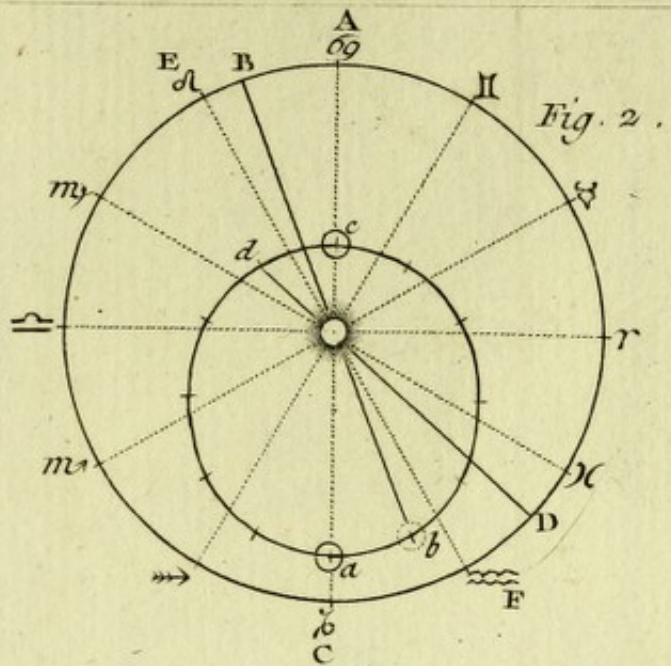
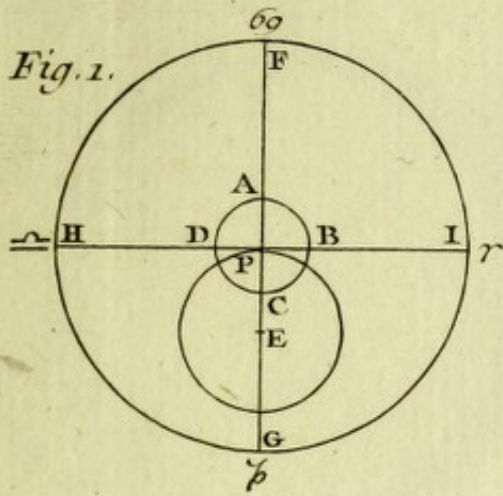


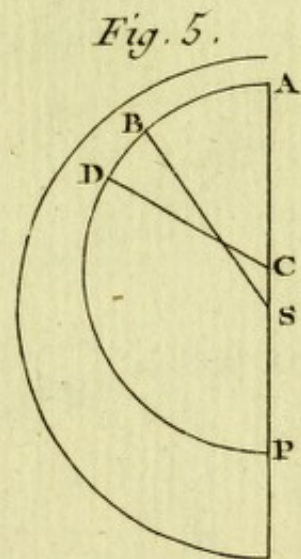
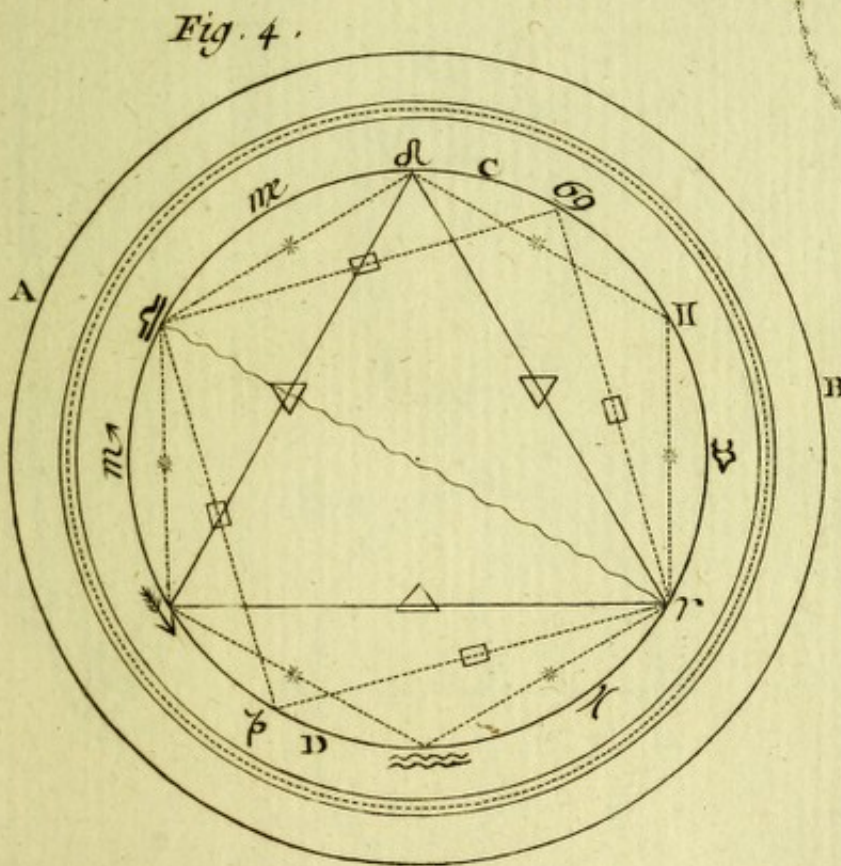
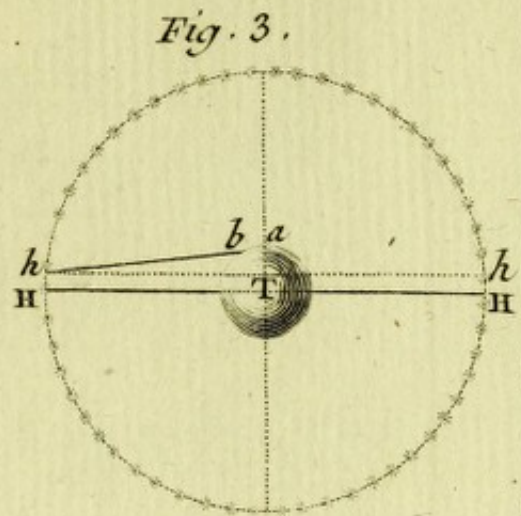
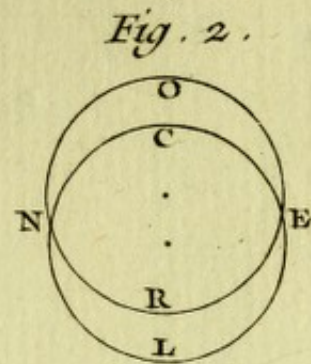
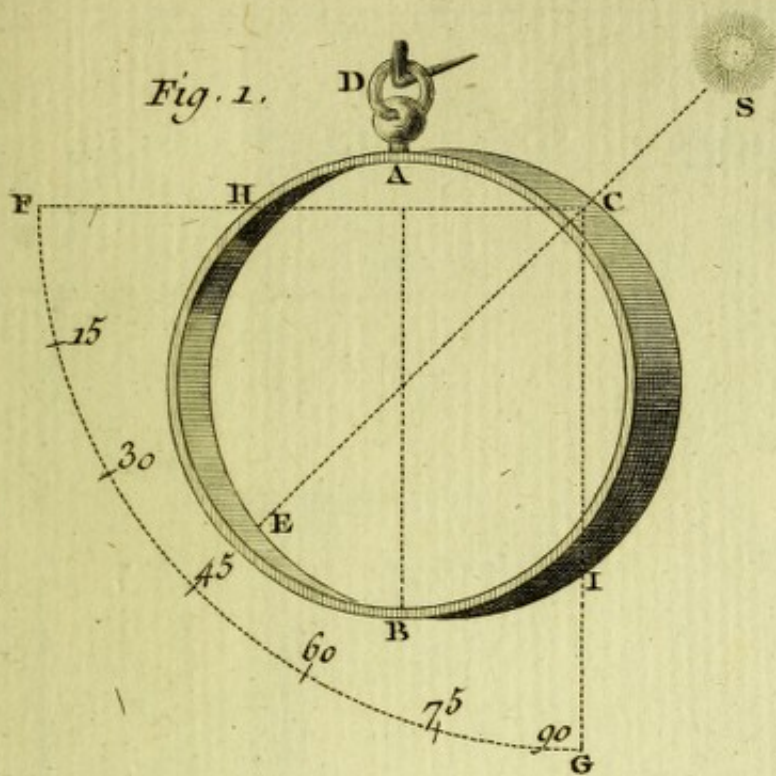
Fig. 5.



Physique.







Physique.

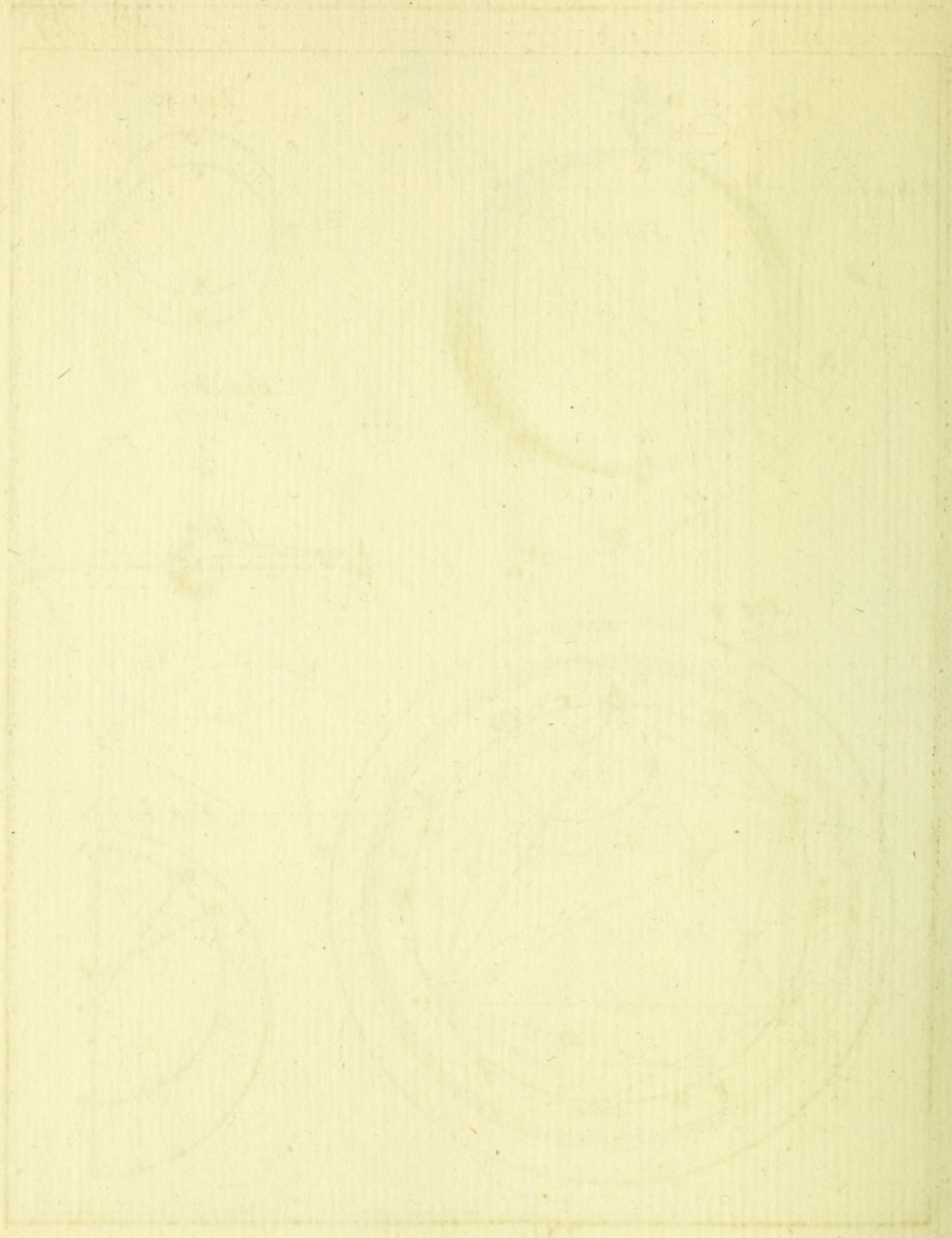


Fig. 4.

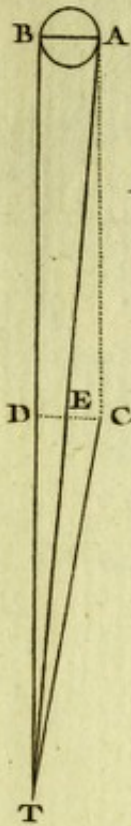
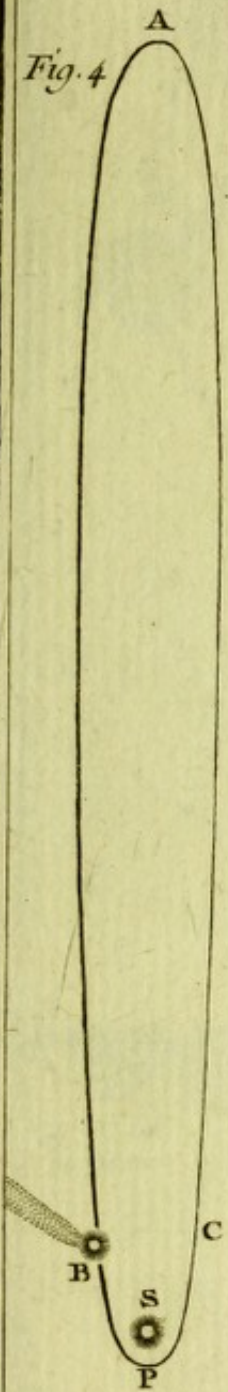


Fig. 3.

Fig. 1.



Fig. 2.

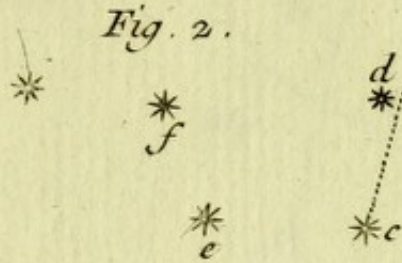


Fig. 5.

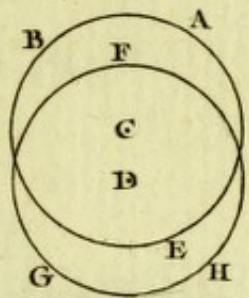


Fig. 6.

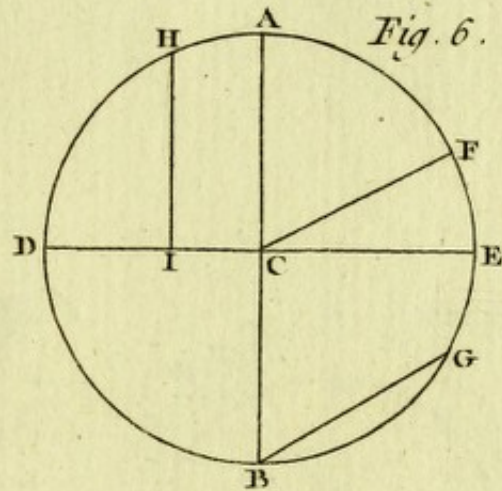


Fig. 7.

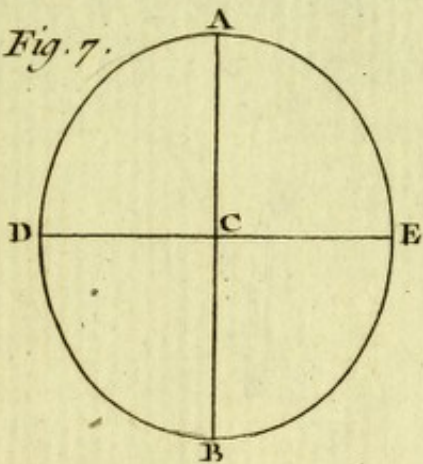
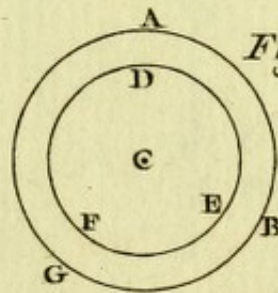


Fig. 8.



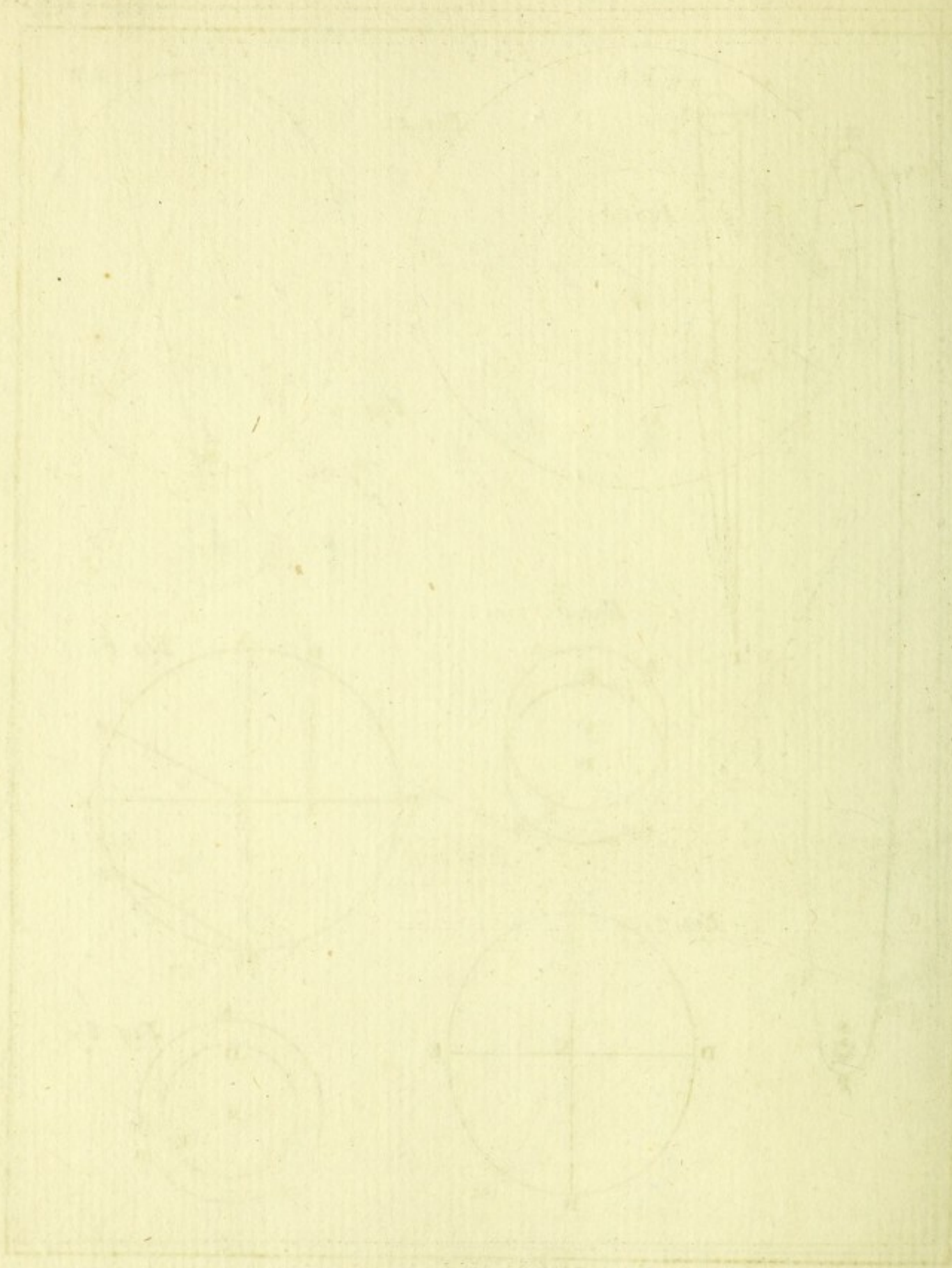


Fig. 1.

Fig. 2.

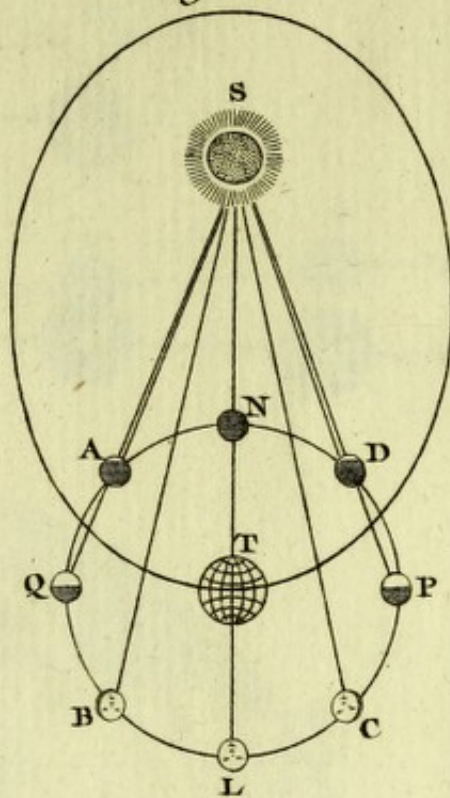
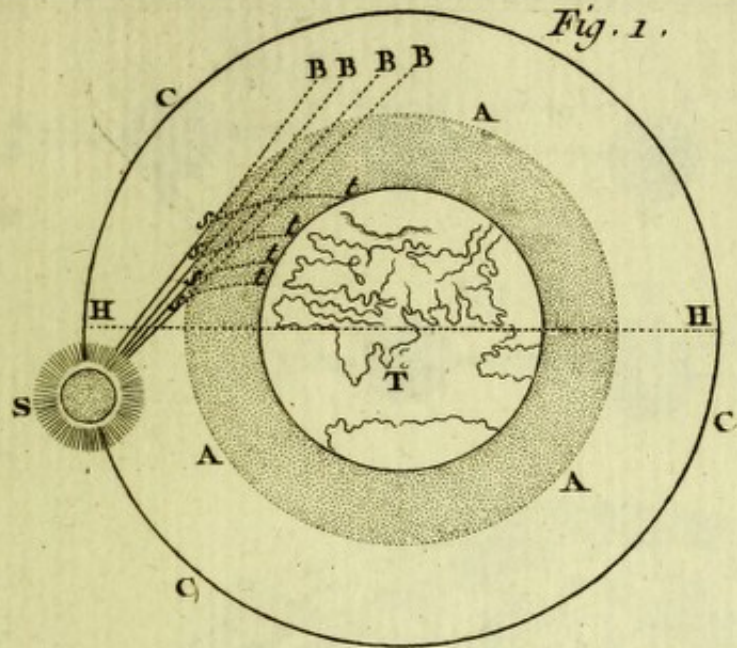


Fig. 3.

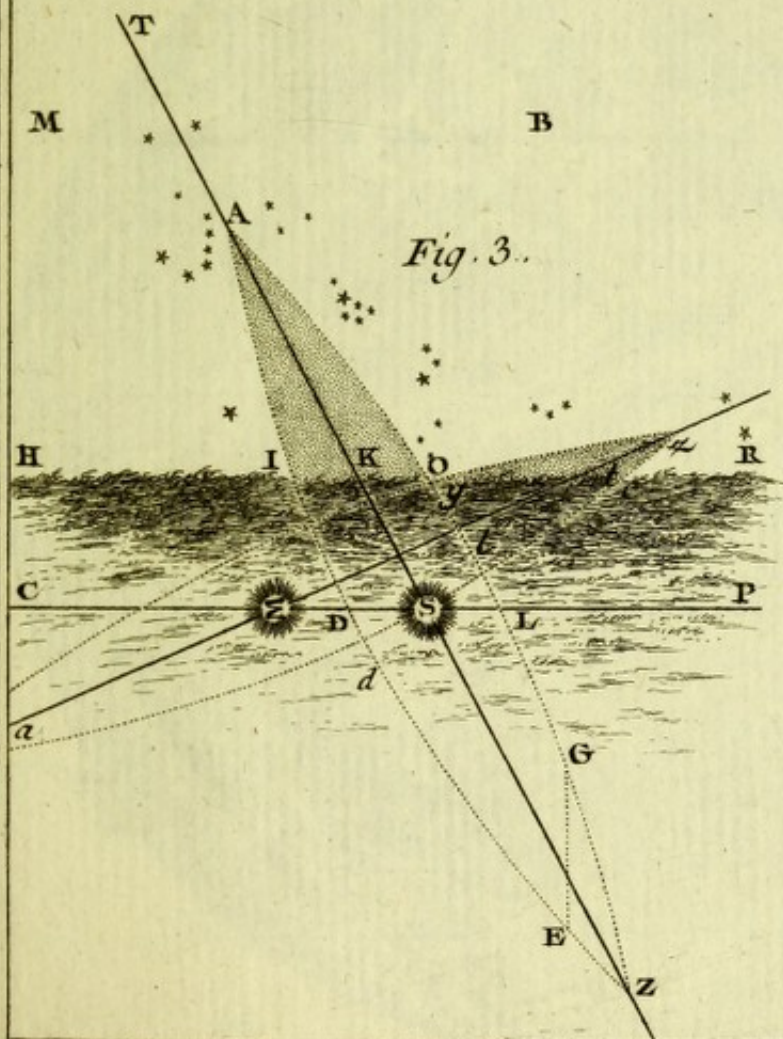
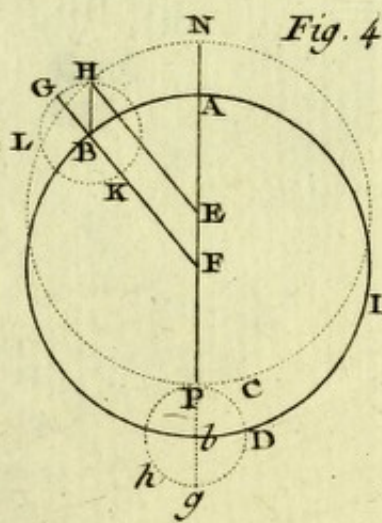
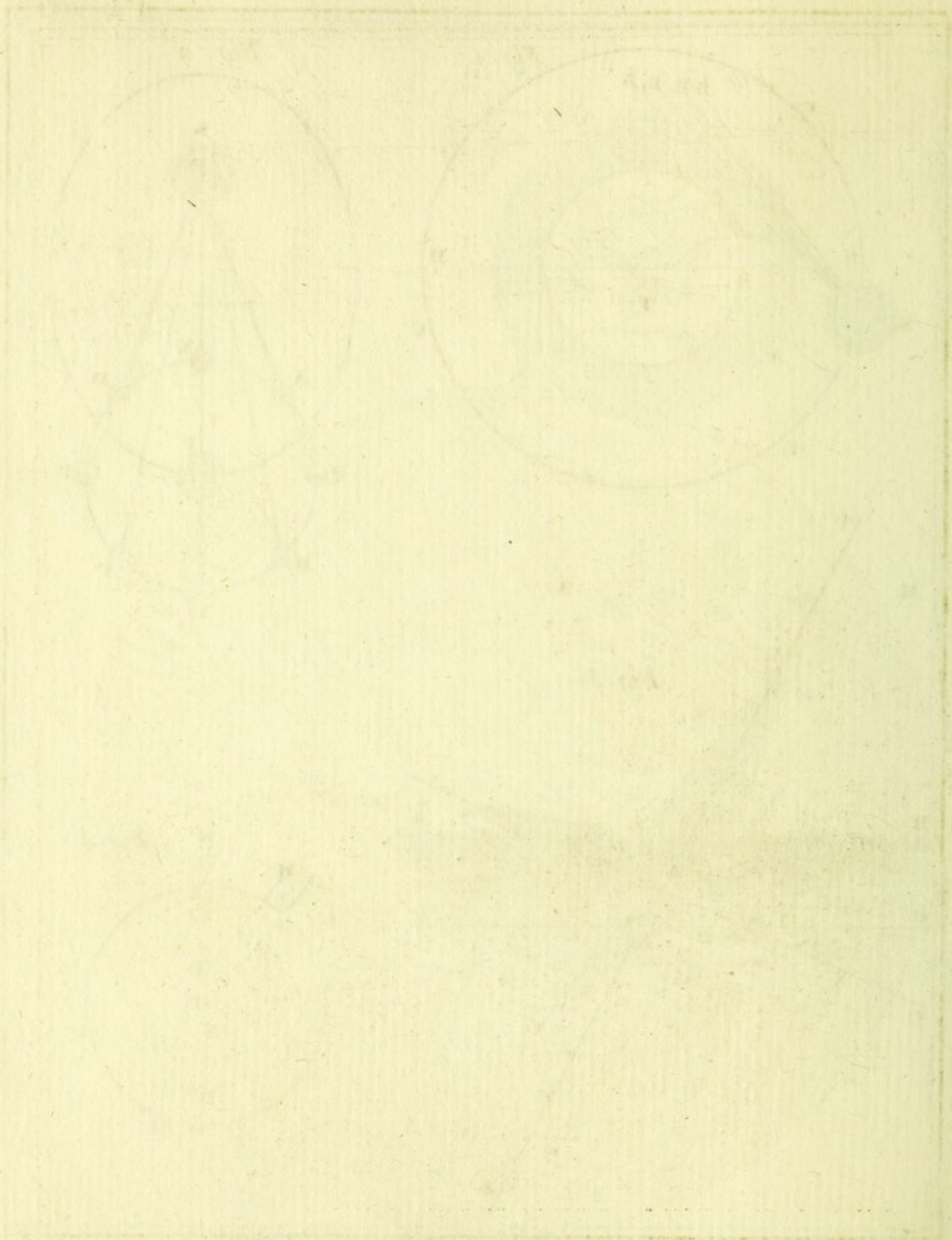
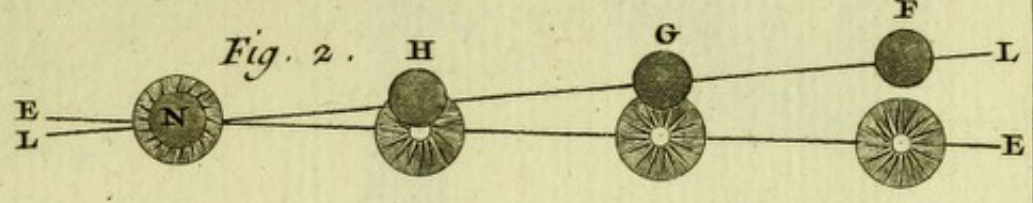
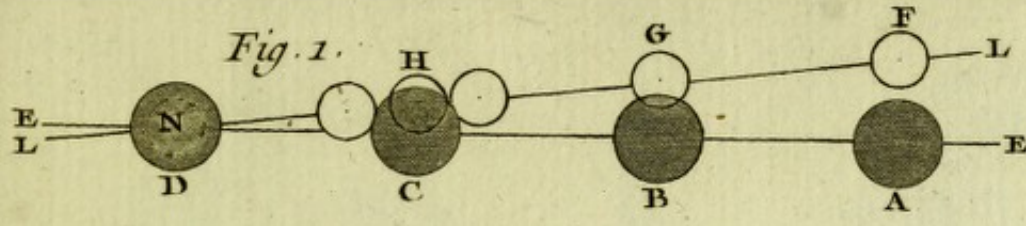


Fig. 4.



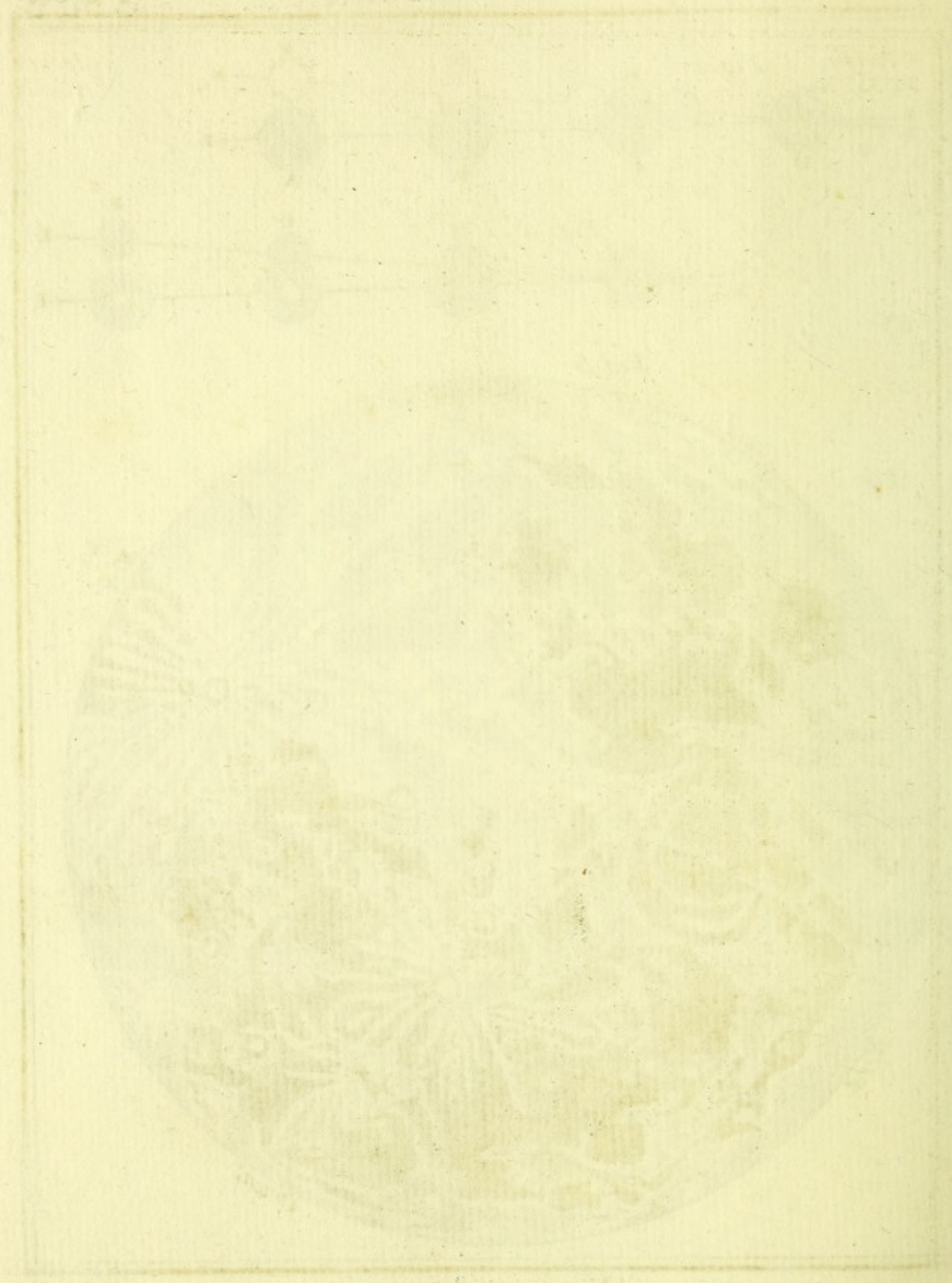
Physique.





Physique.

1866



LIBRARY

○ Perigée
32' 33" 30.

○ Apogée.
31' 30" 30."

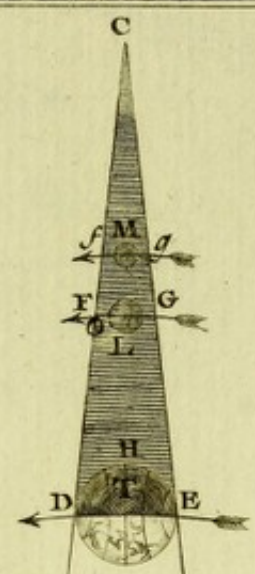
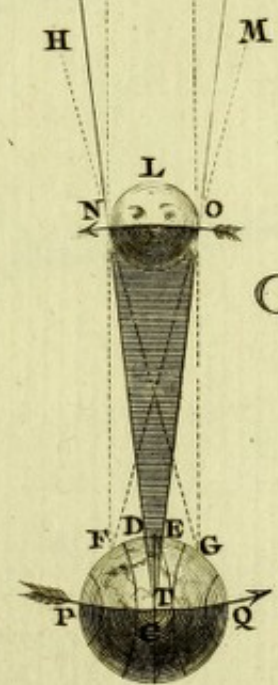
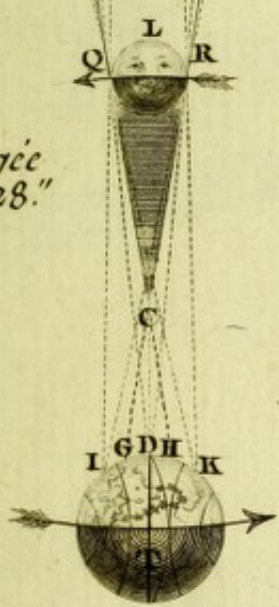


Fig. 3 .

Fig. 1.ere

Fig. 2 .

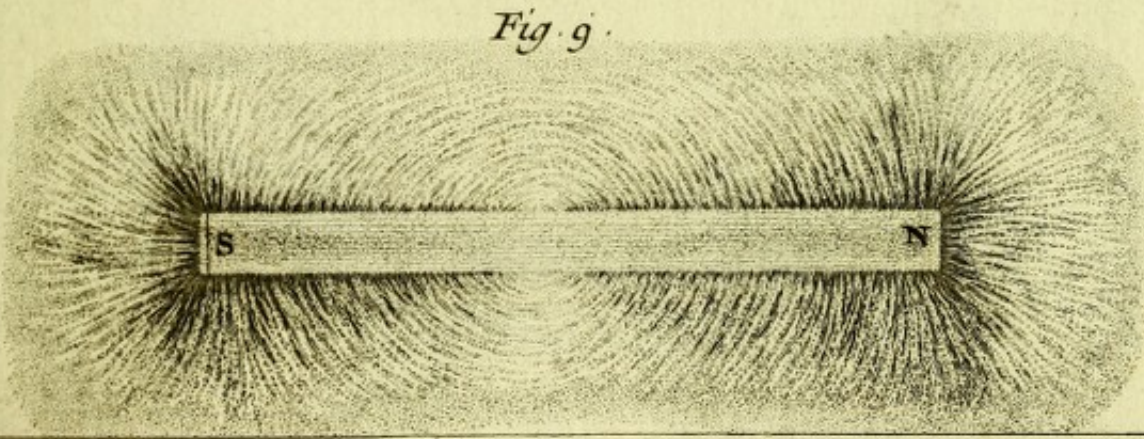
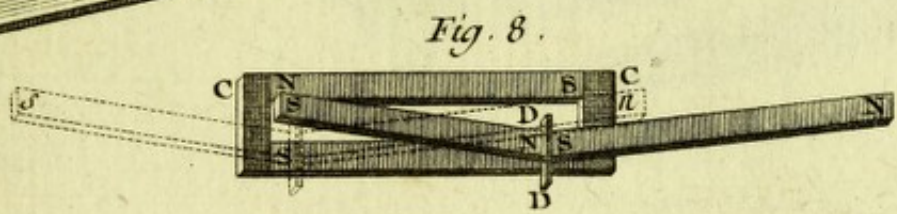
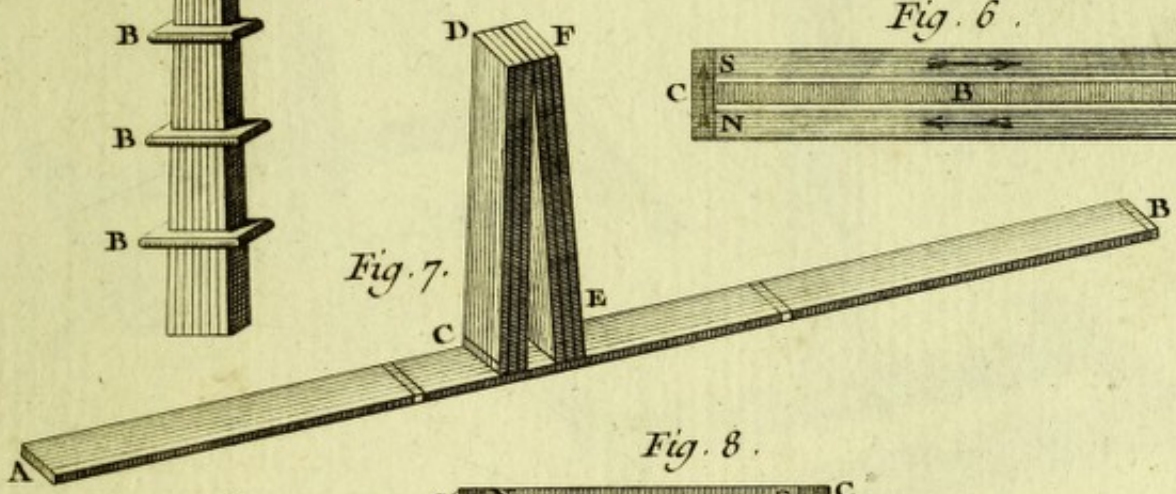
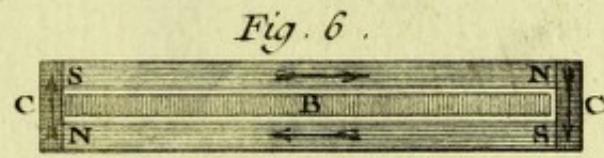
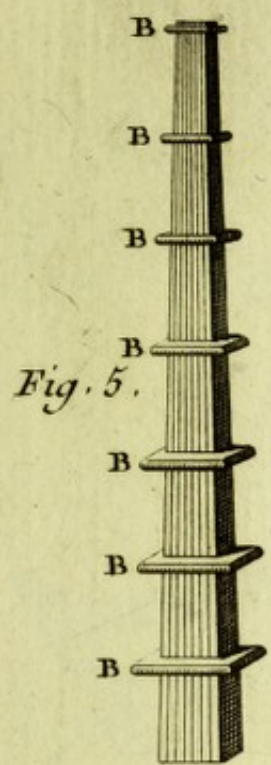
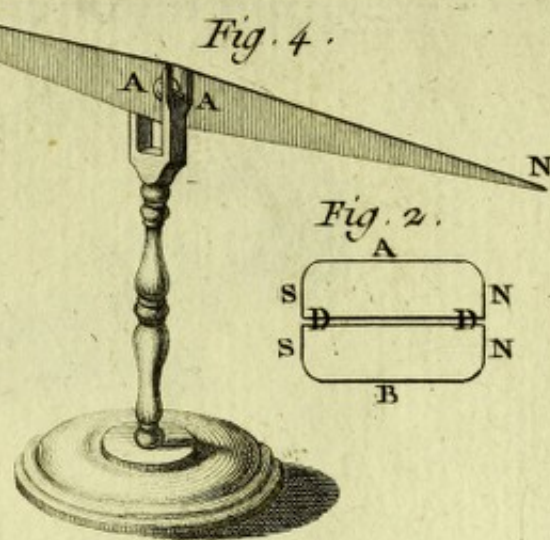
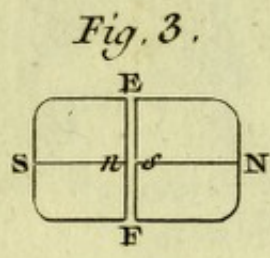
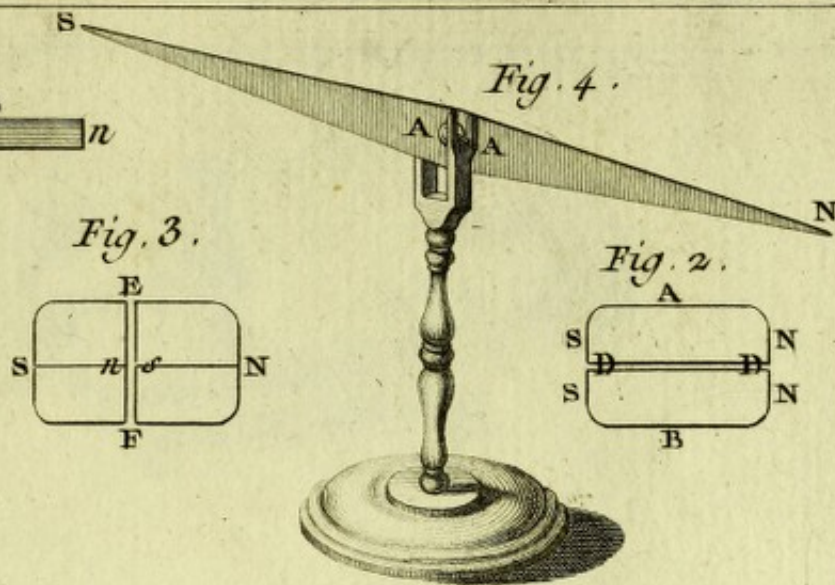
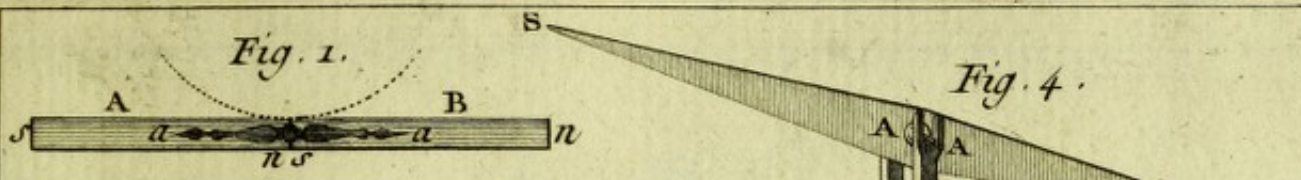
○ Apogée
29' 28."



○ Perigée
33' 36"

Moy - dist - ○ 32' 2" ☾ 31' 32"

Physique



Physique.

Fig. 1.

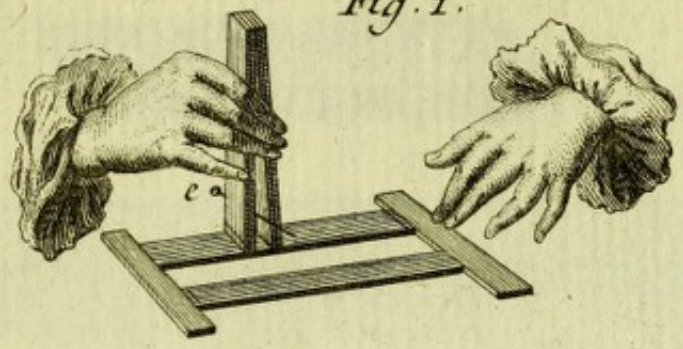


Fig. 2.

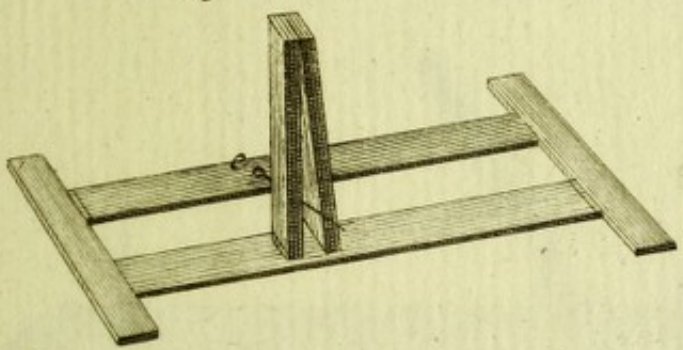


Fig. 3.

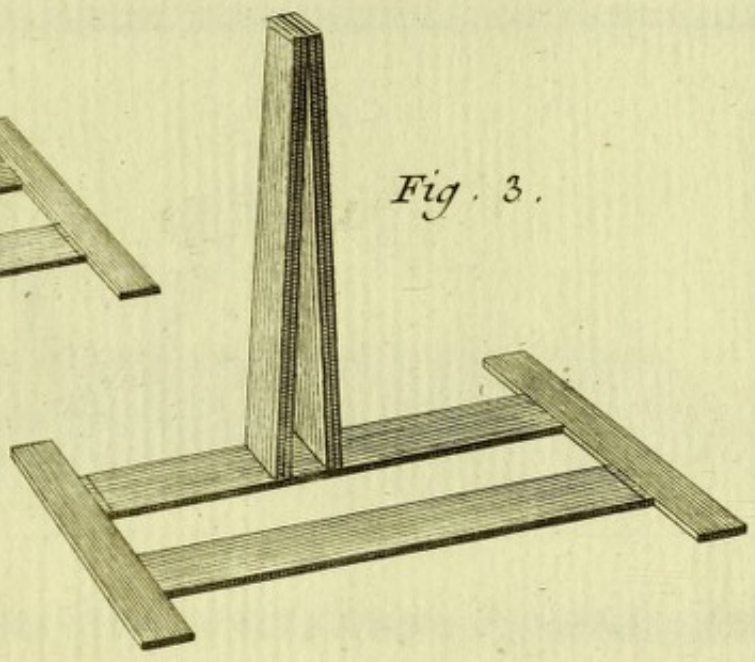
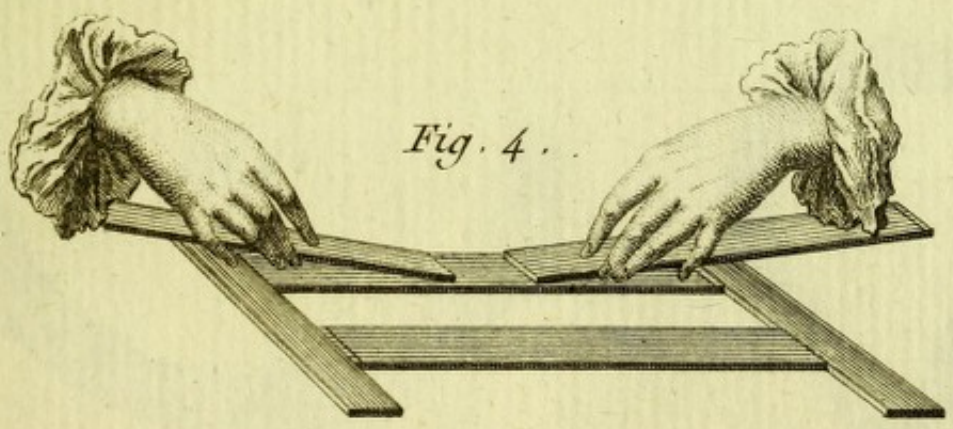


Fig. 4.



Physique.

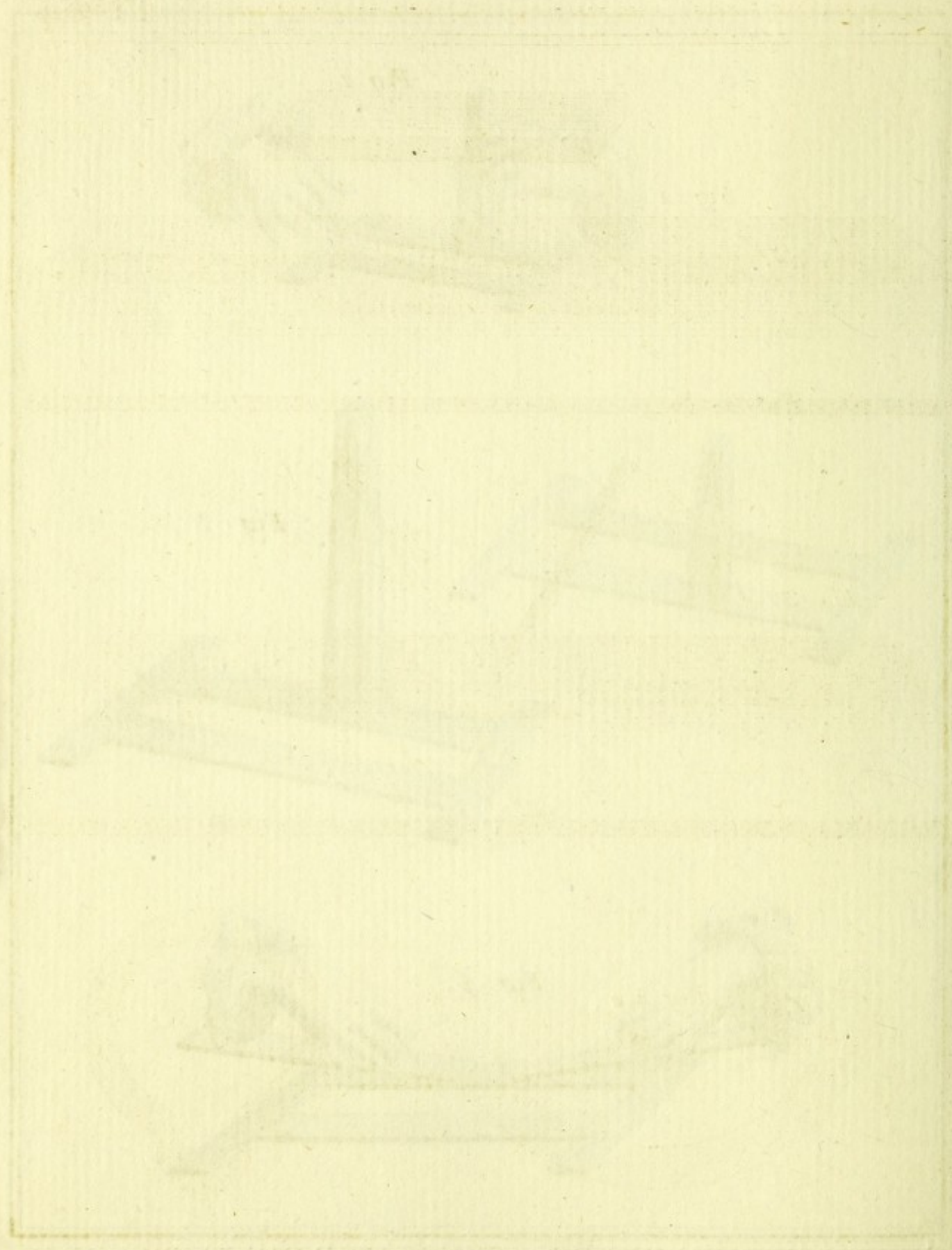


Fig. 1.



Fig. 2.

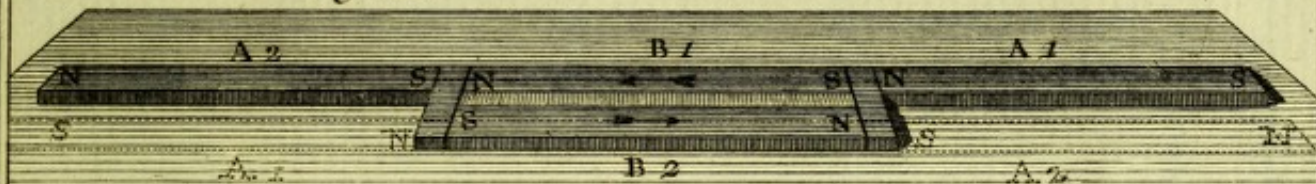


Fig. 3.

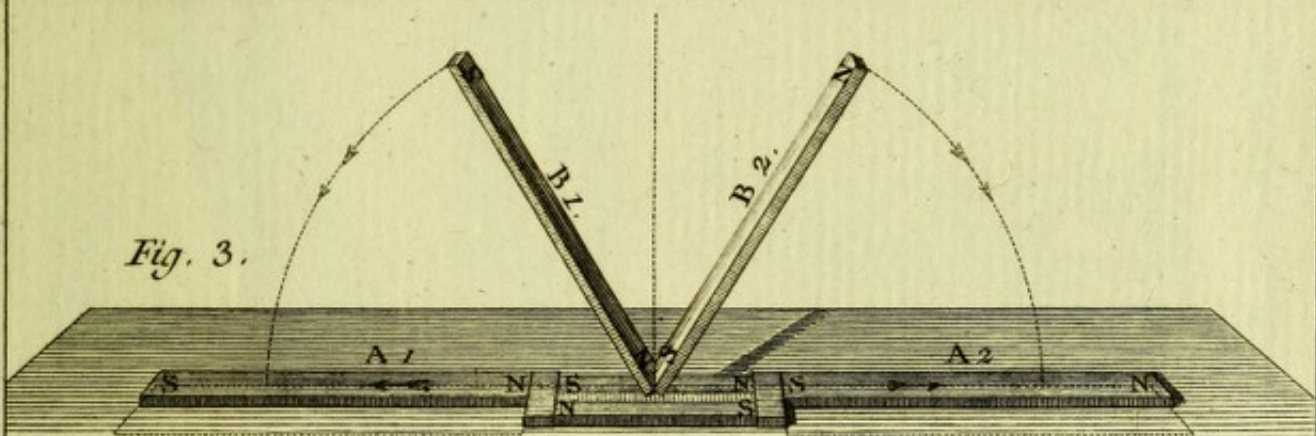


Fig. 4.

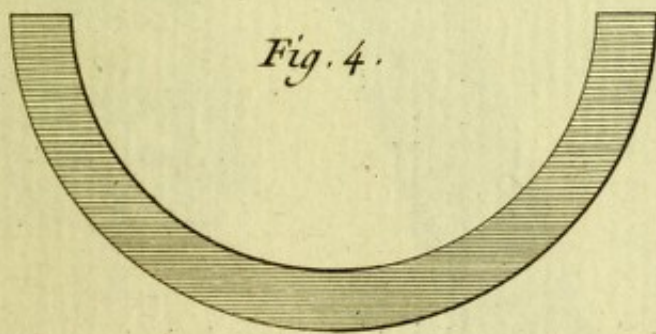
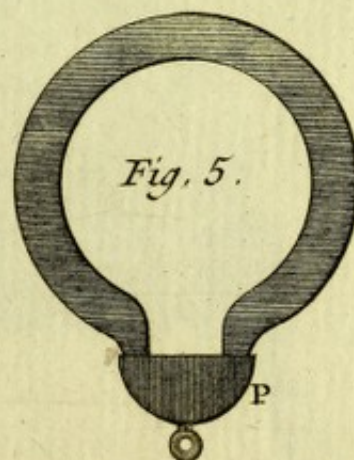
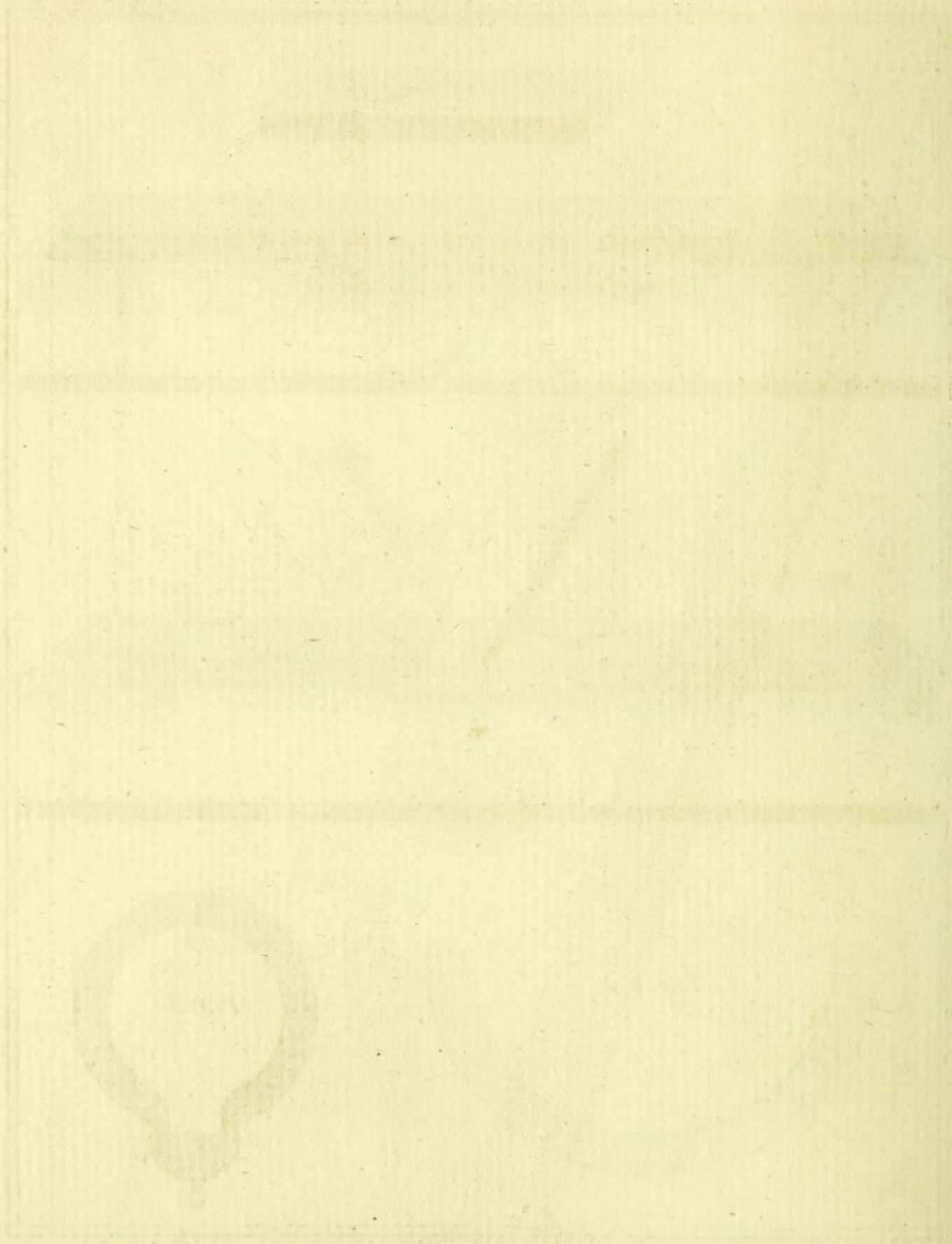
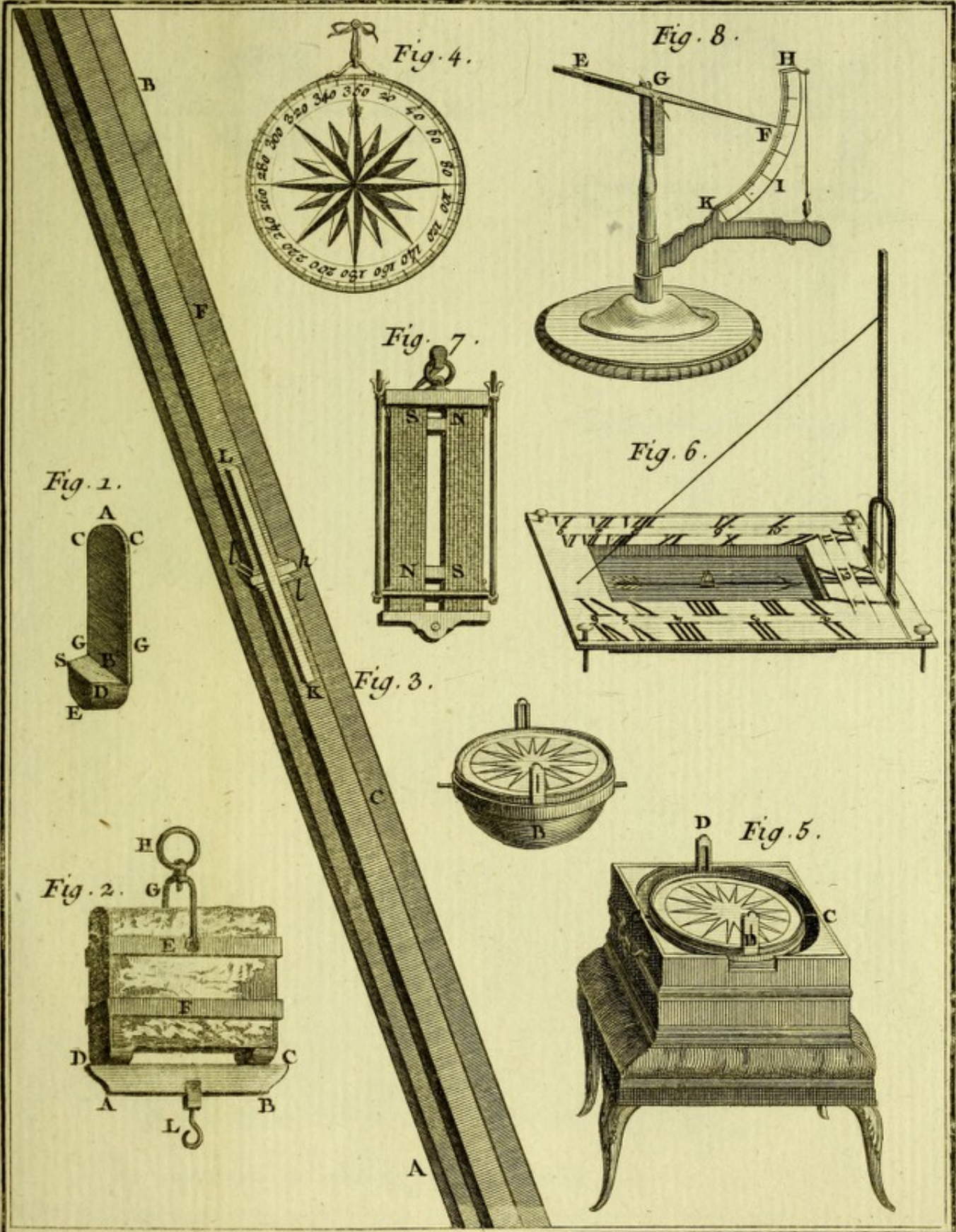


Fig. 5.



1881





Benard Duxart.

Physique.

1812



Fig. 6.

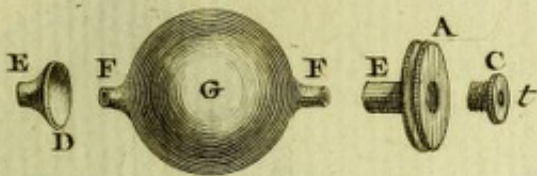


Fig. 5.

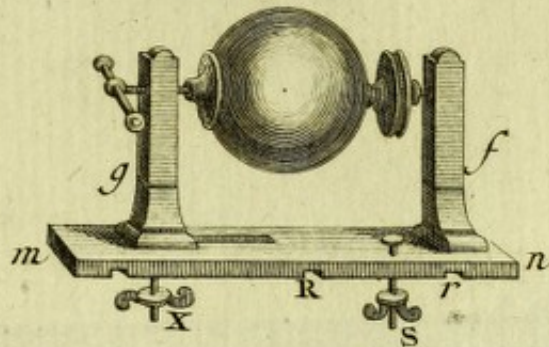


Fig. 3.

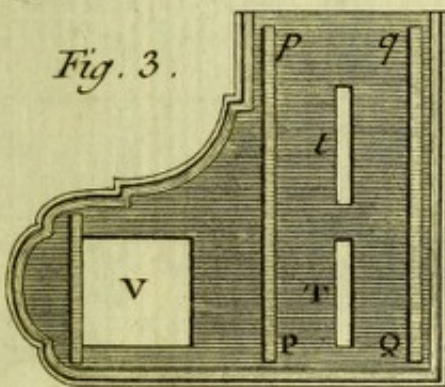


Fig. 2.

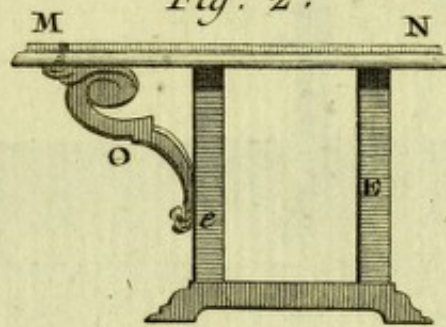


Fig. 1.

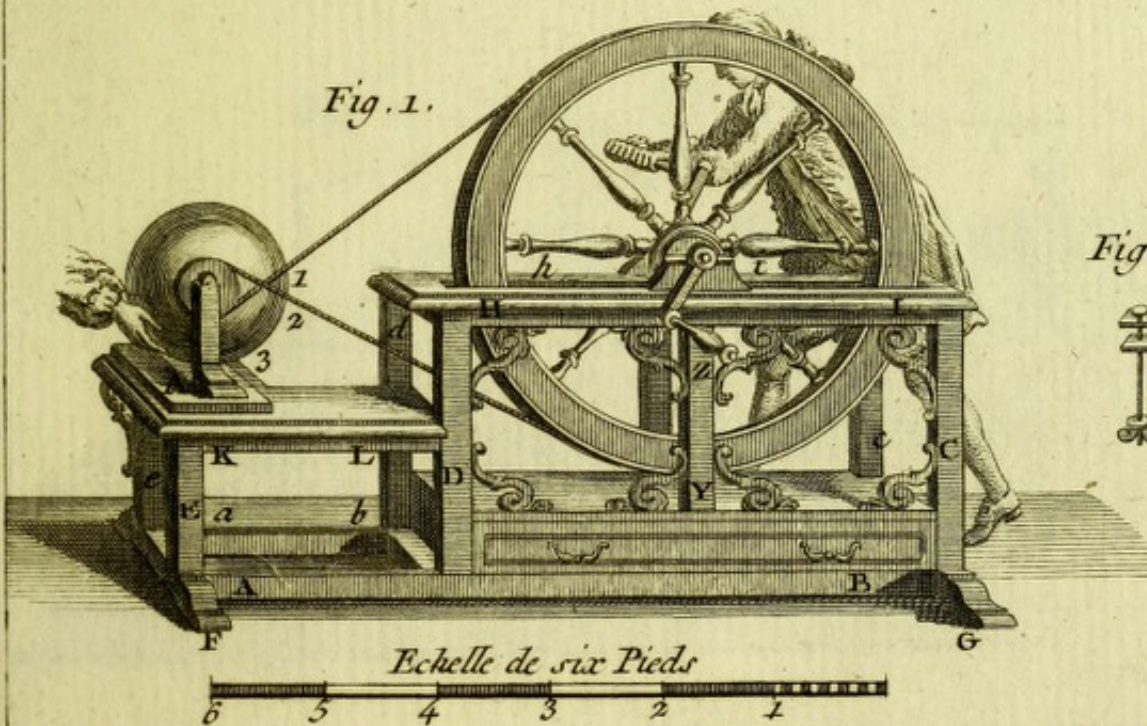
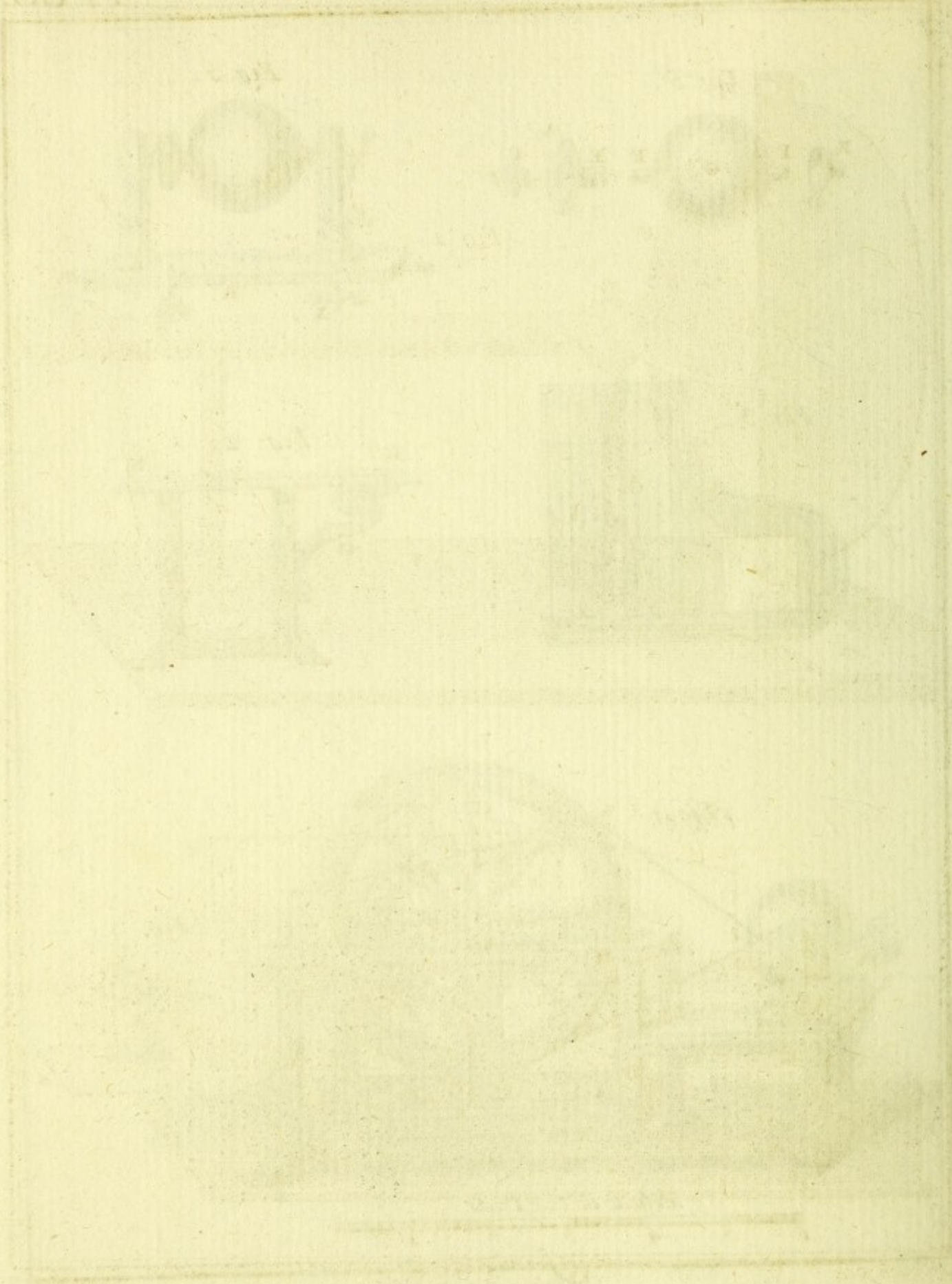


Fig. 4.





Architectural drawing

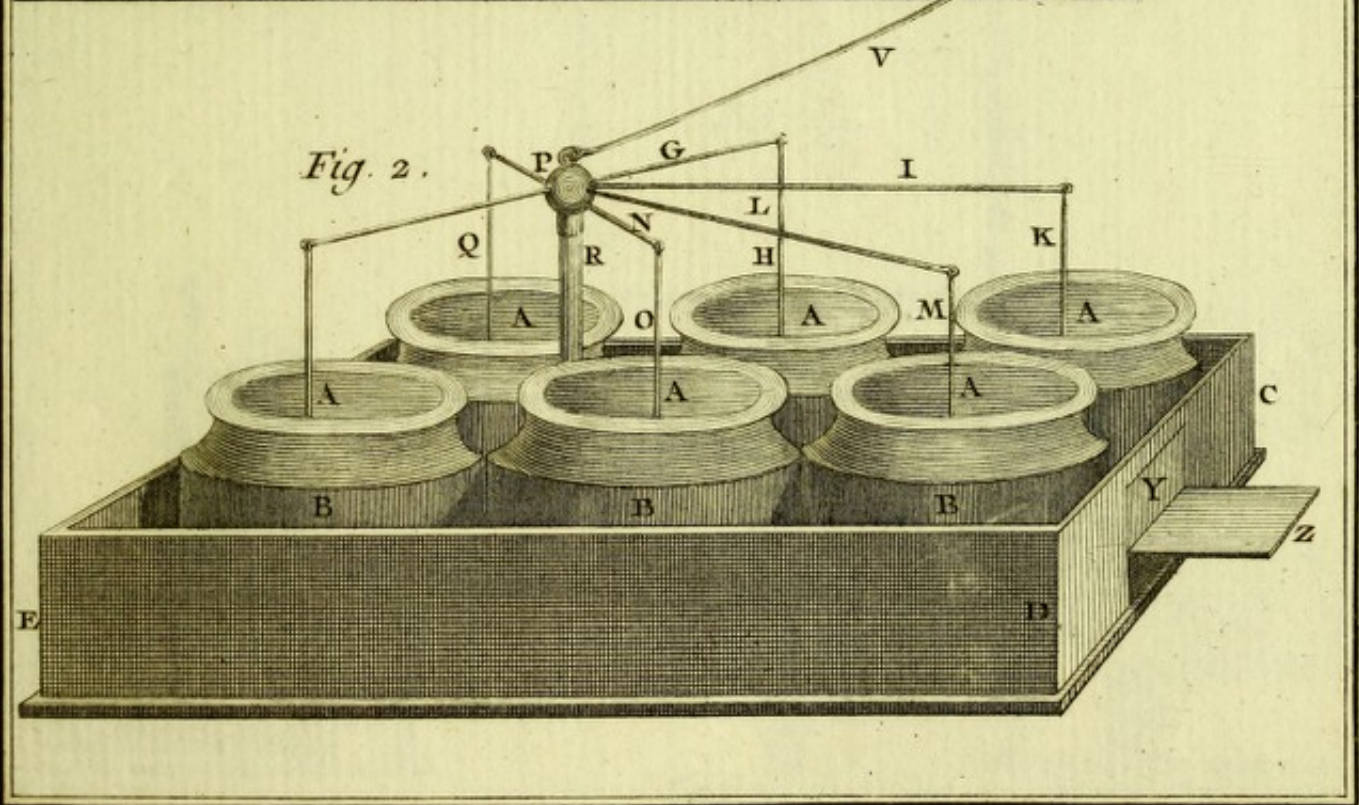
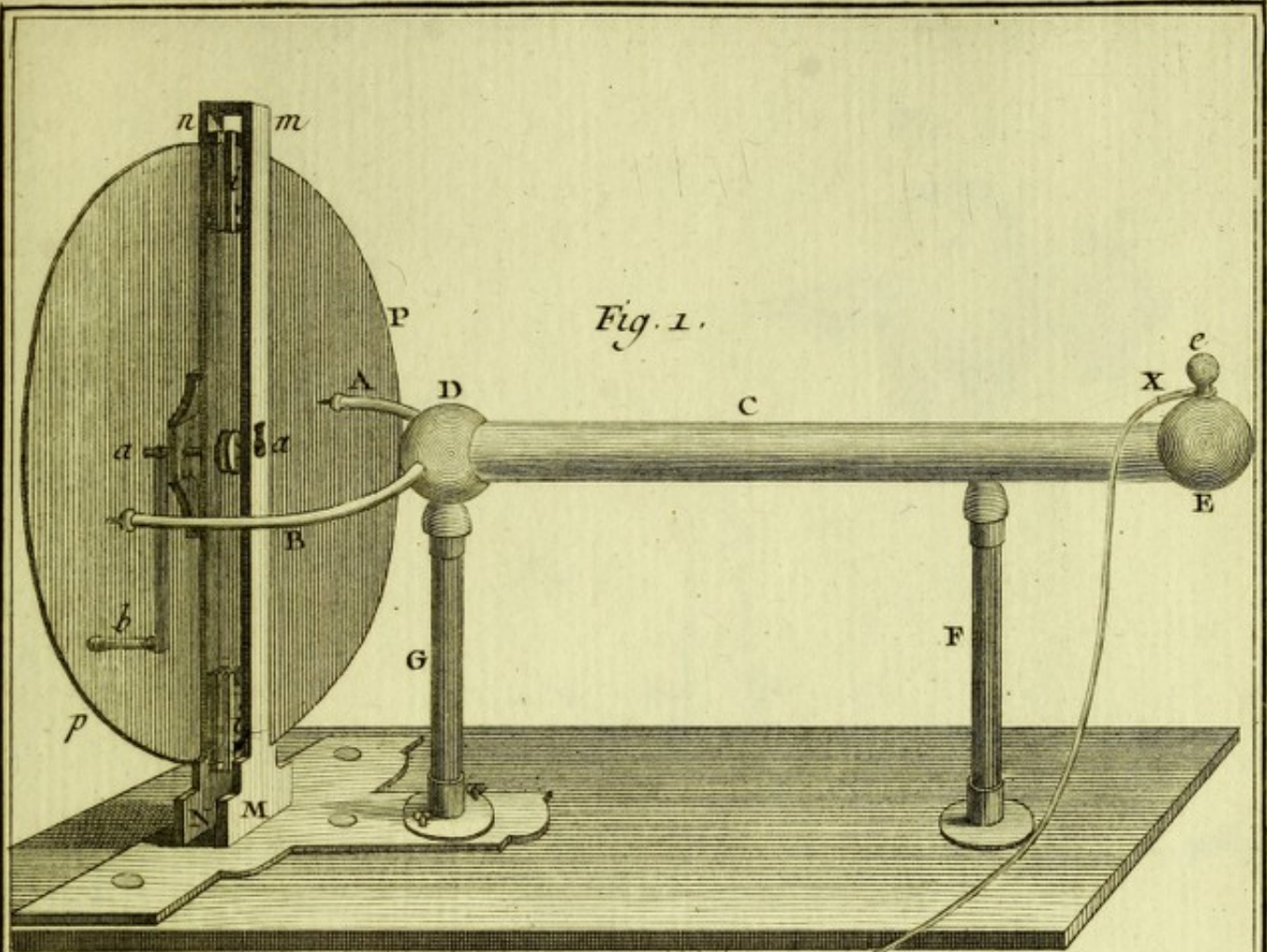


Fig. 1.

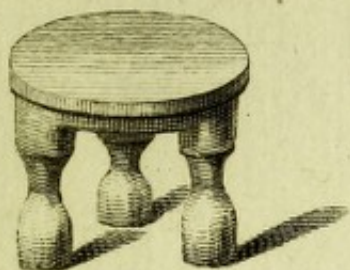


Fig. 2.

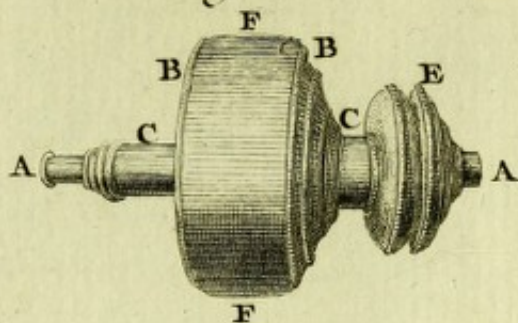


Fig. 3.

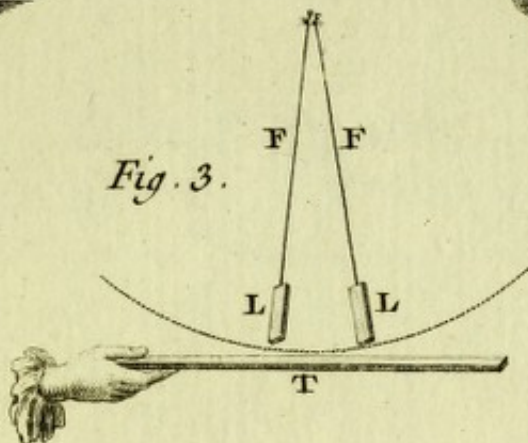
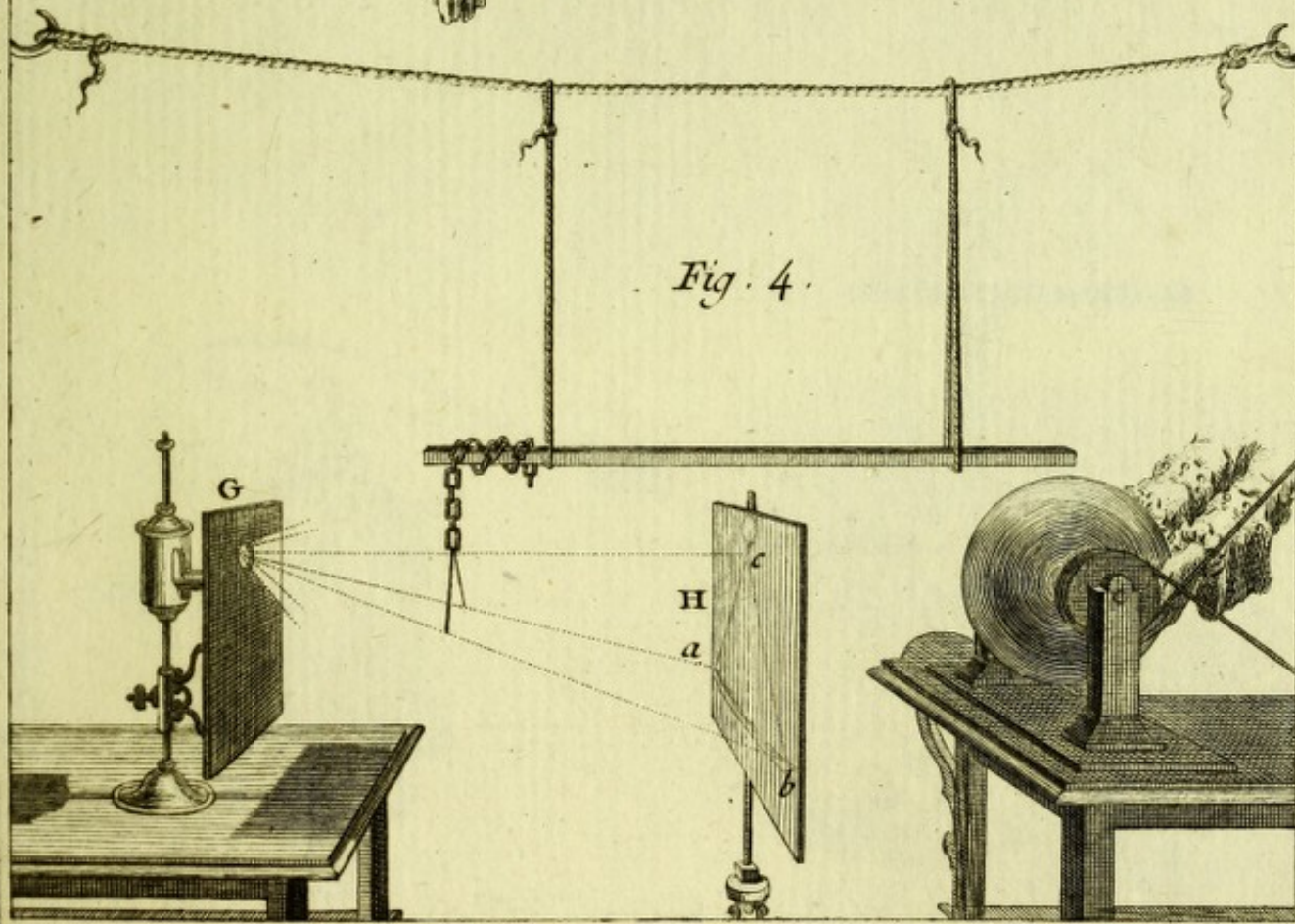


Fig. 4.



Physique.

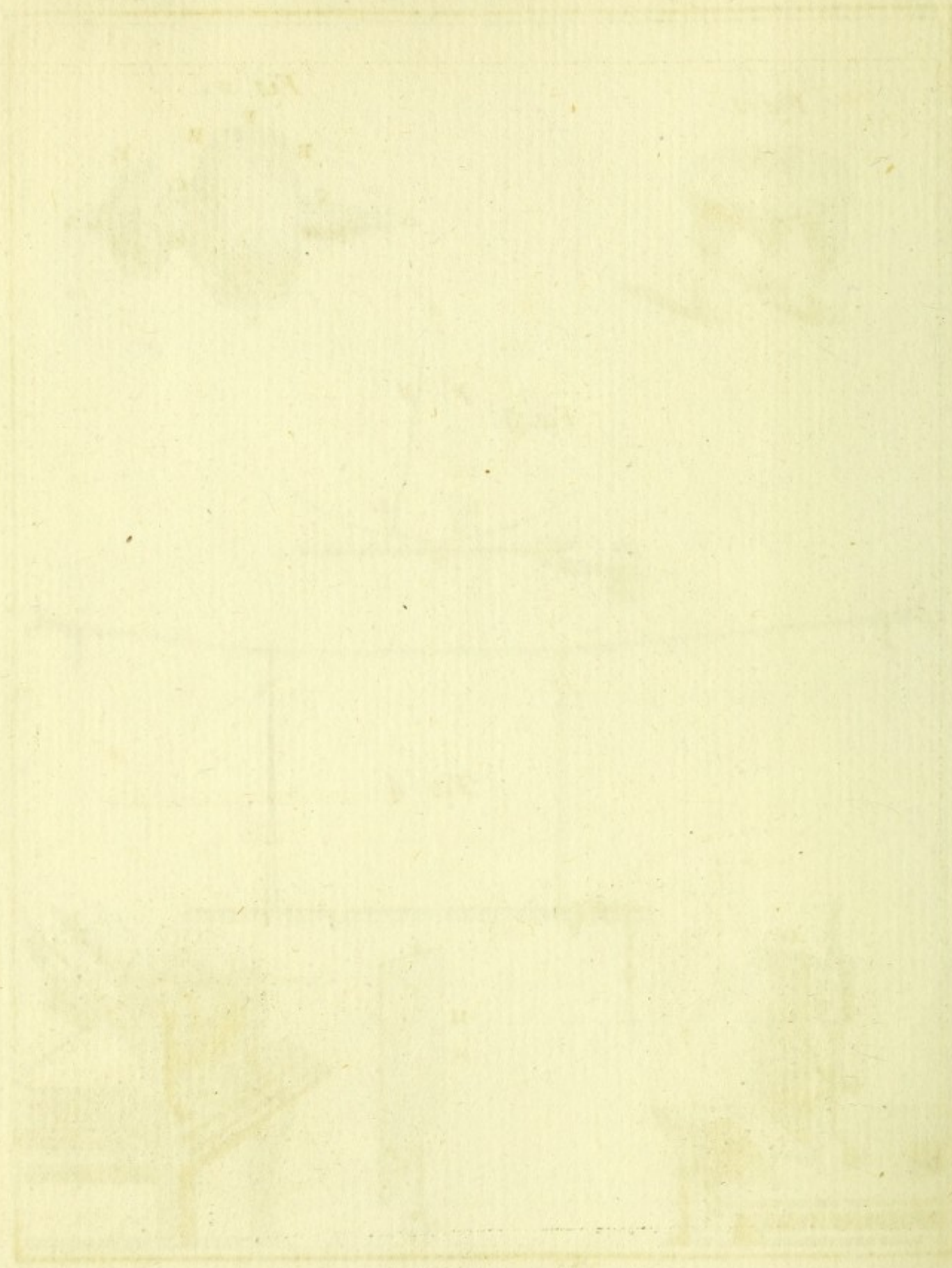


Fig. 1.

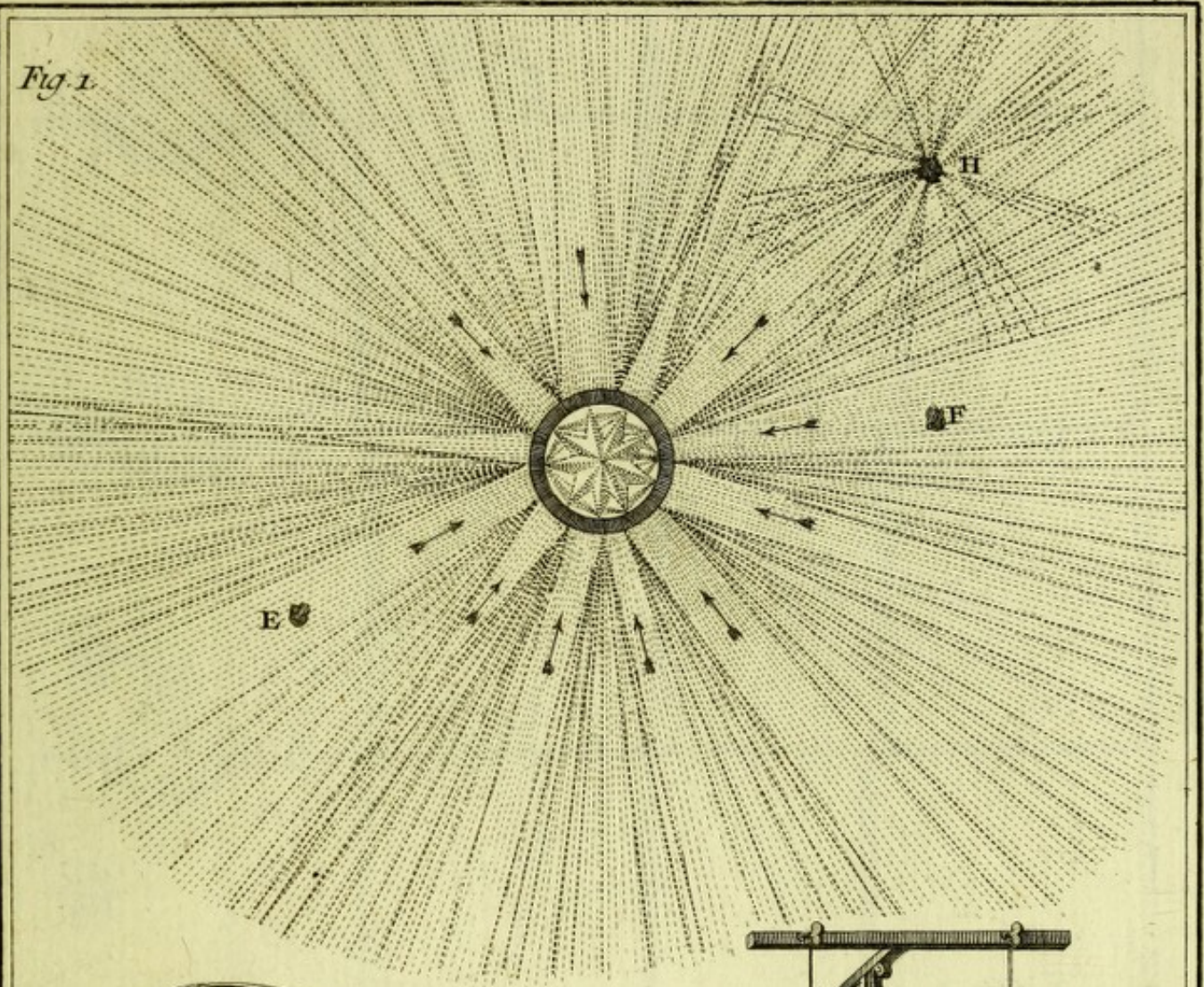


Fig. 3.

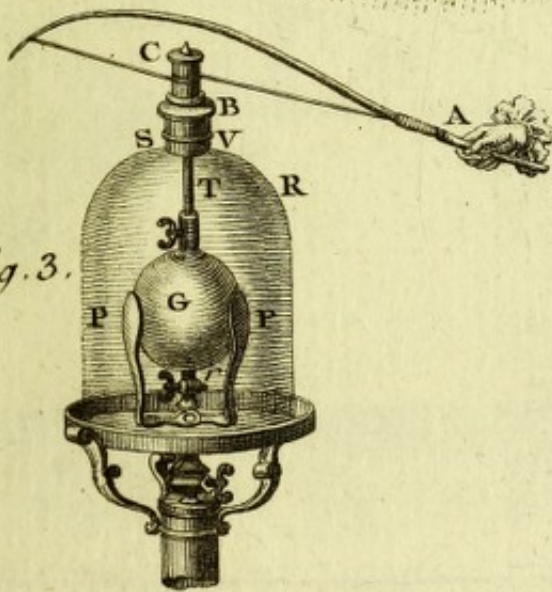
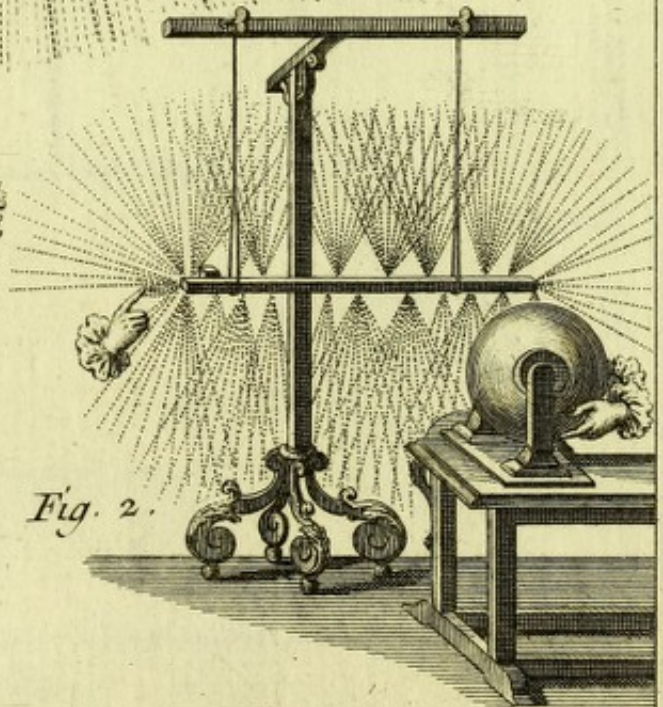
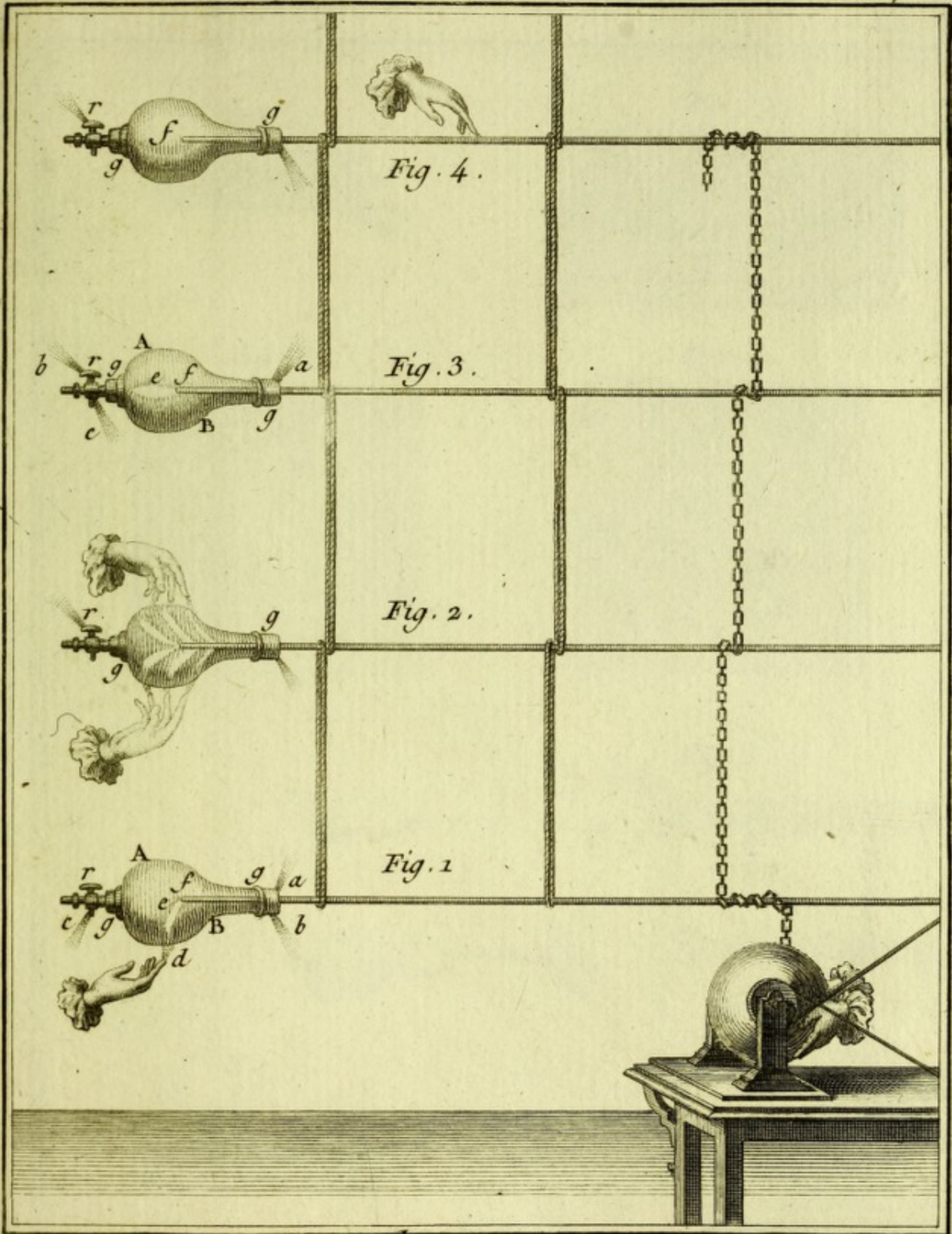


Fig. 2.



Physique.



Physique.

Fig. 1.



Fig. 2.

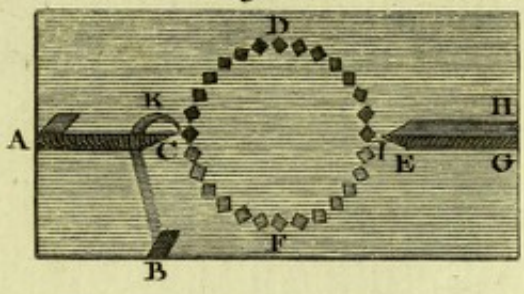


Fig. 3.

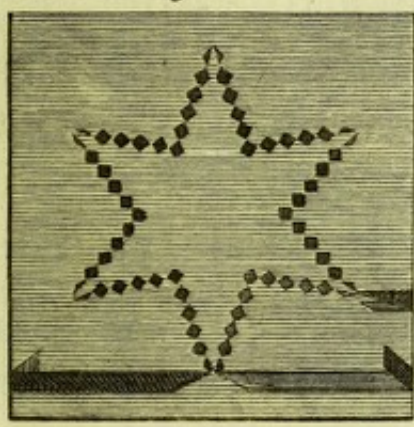


Fig. 4.

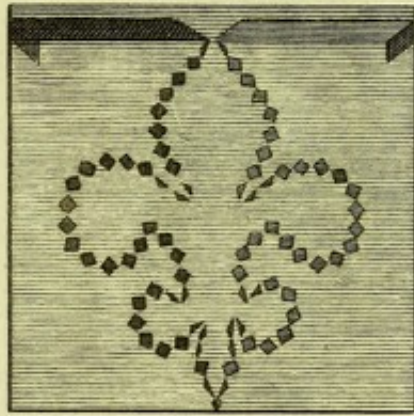


Fig. 5.

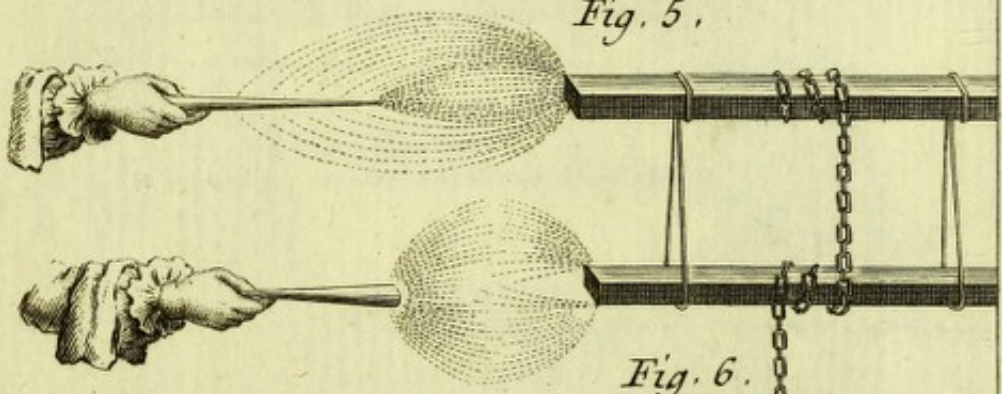


Fig. 6.

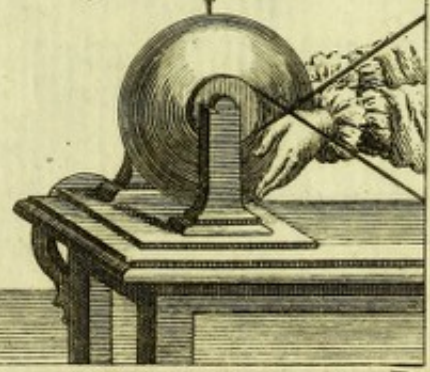
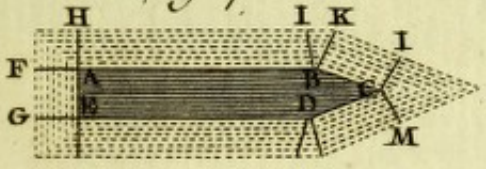


Fig. 7.



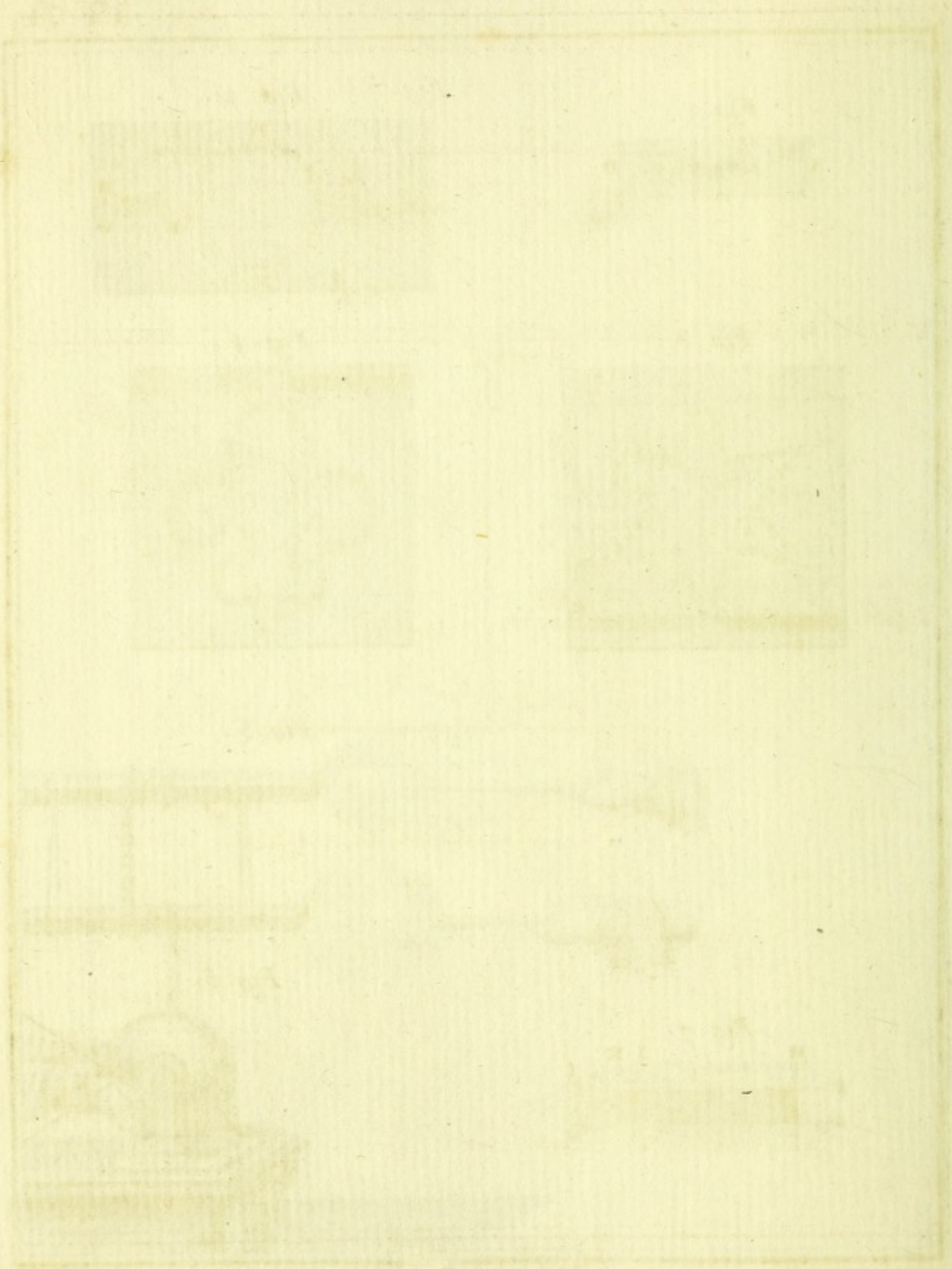


Fig. 5.

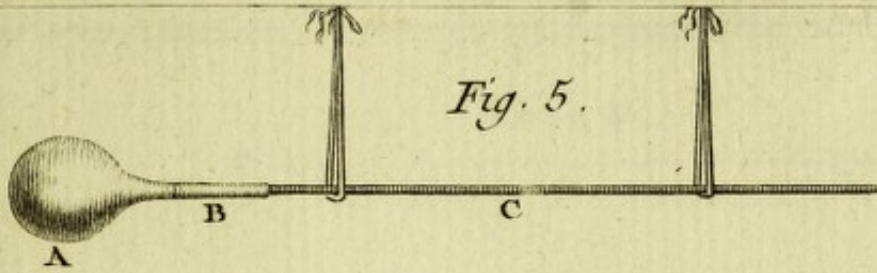


Fig. 4.

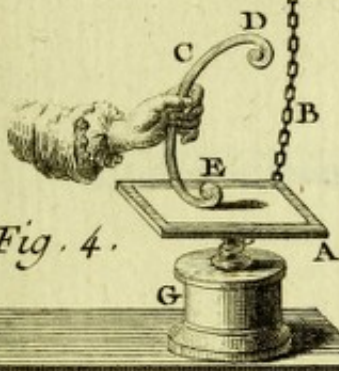
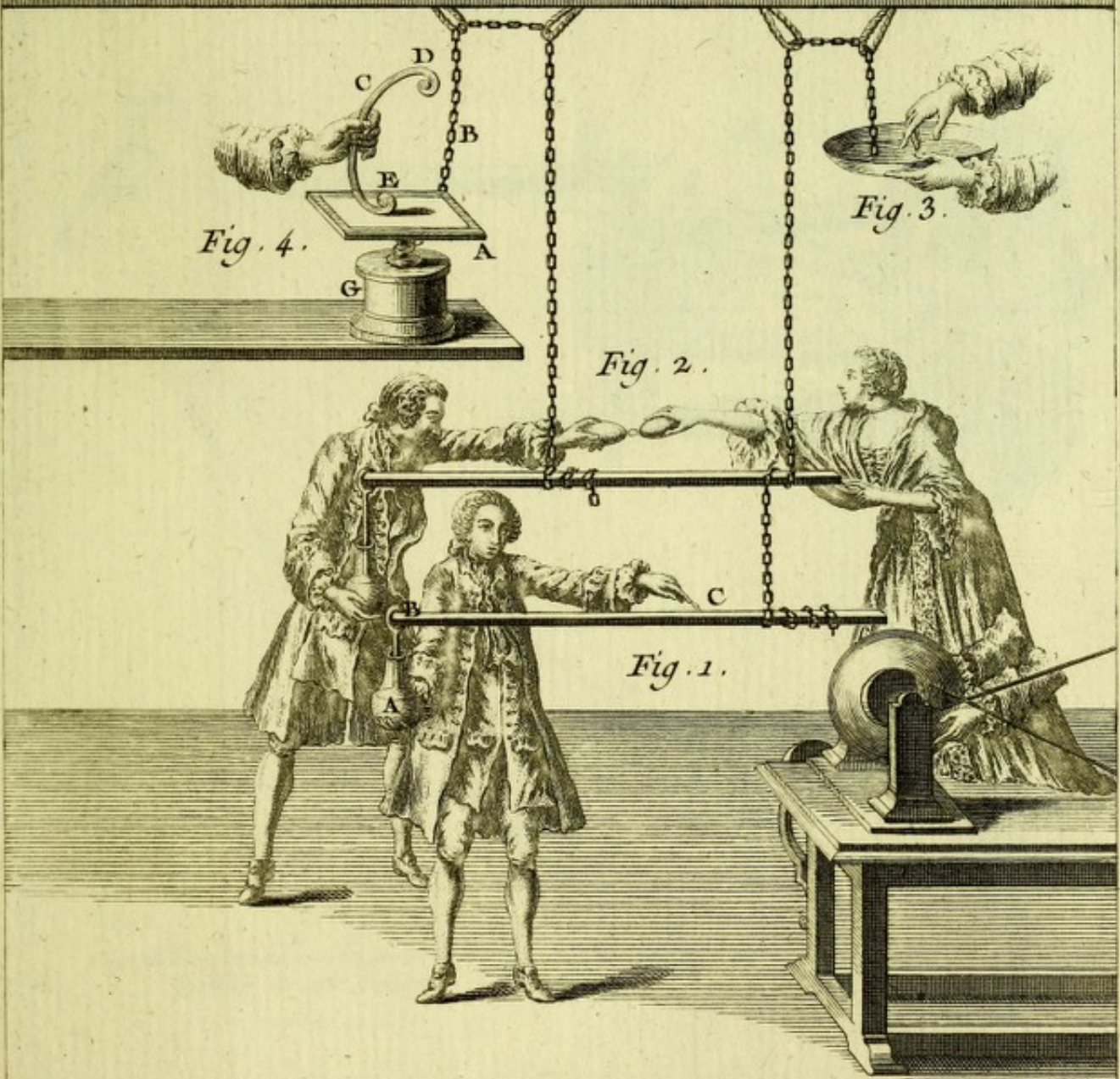


Fig. 3.



Fig. 2.

Fig. 1.



Physique.

Fig. 2.

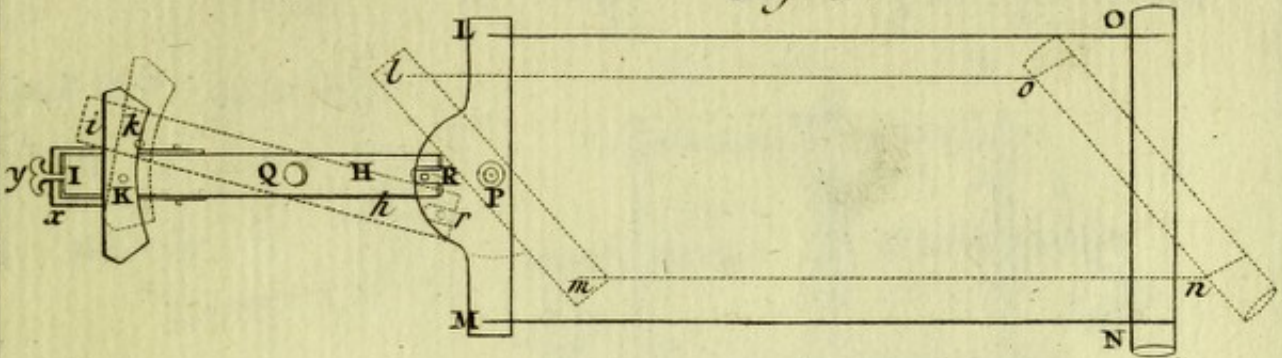


Fig. 1.

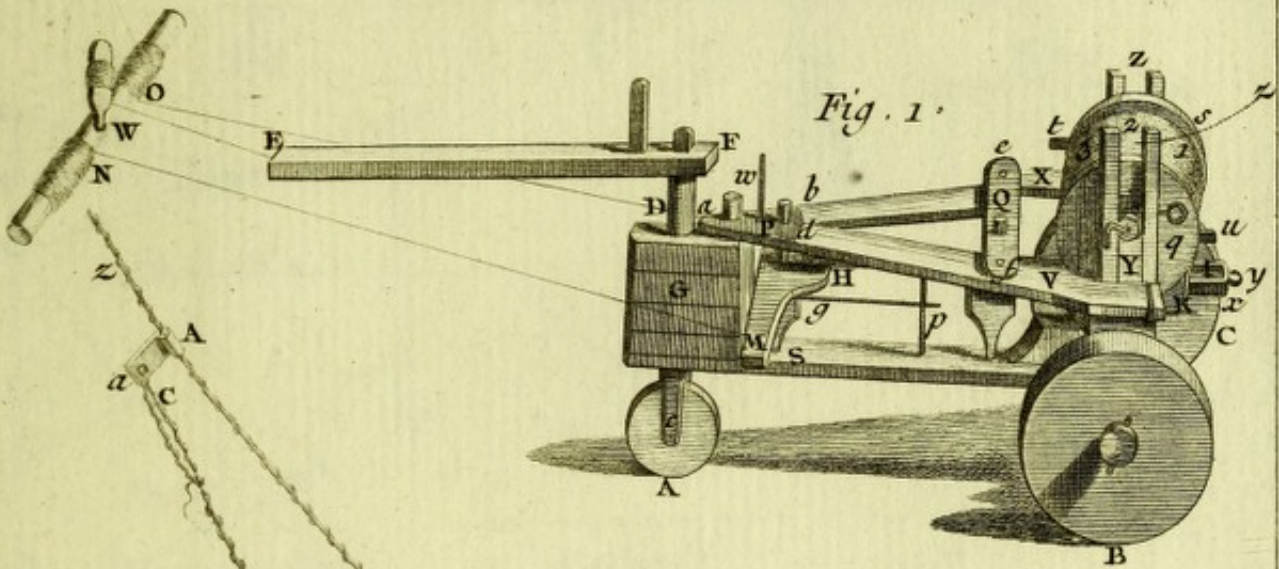
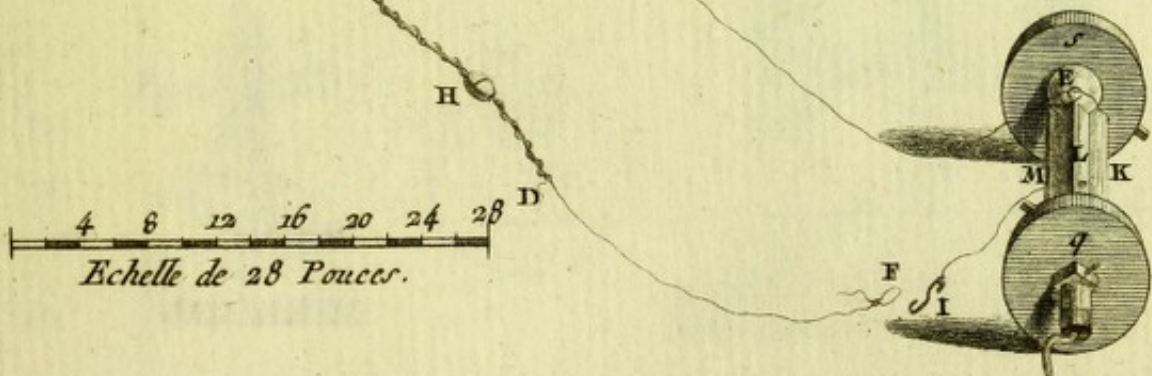
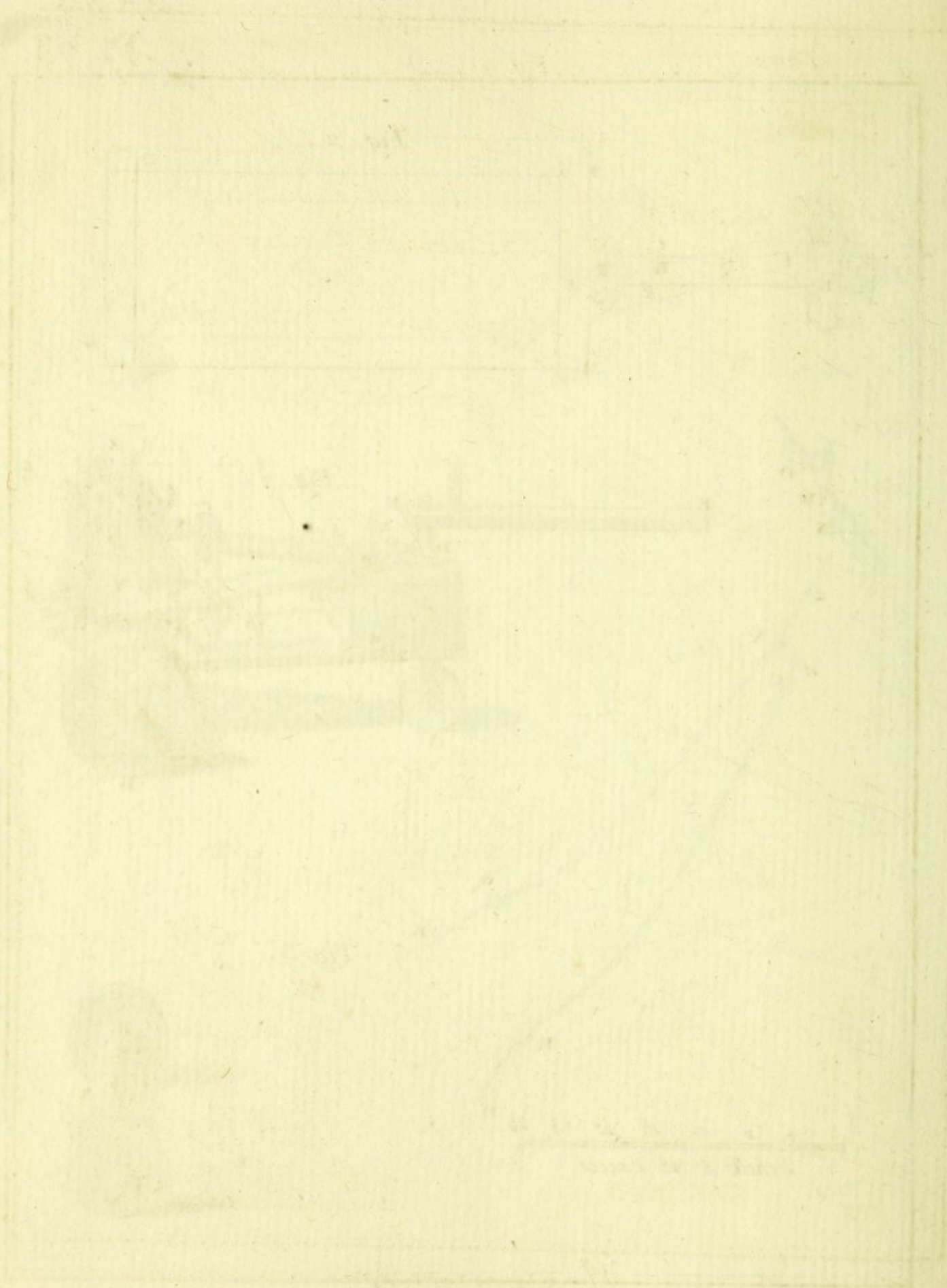
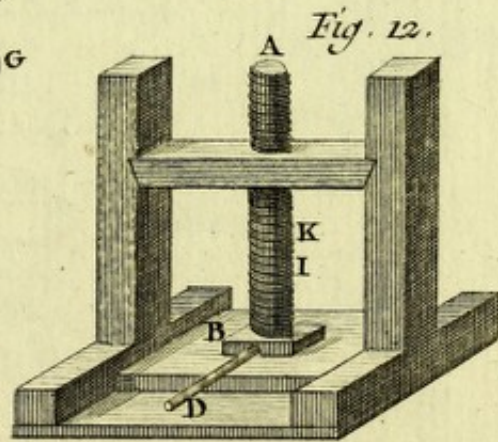
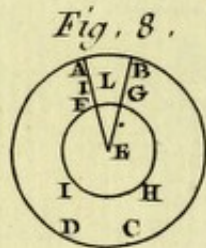
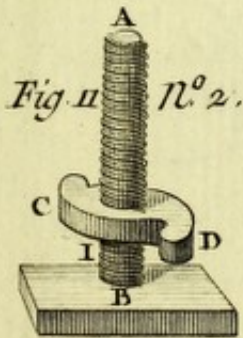
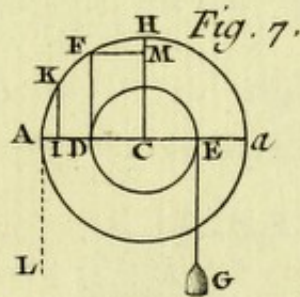
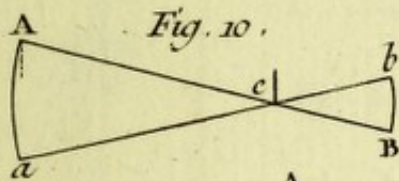
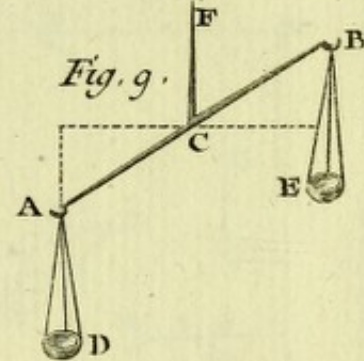
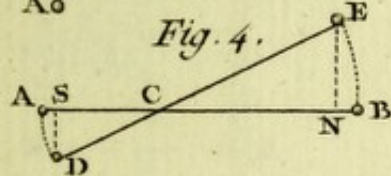
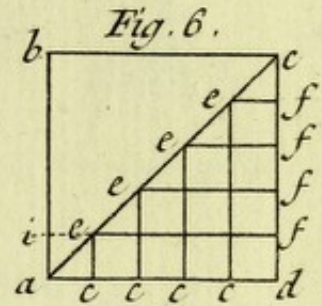
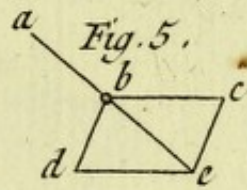
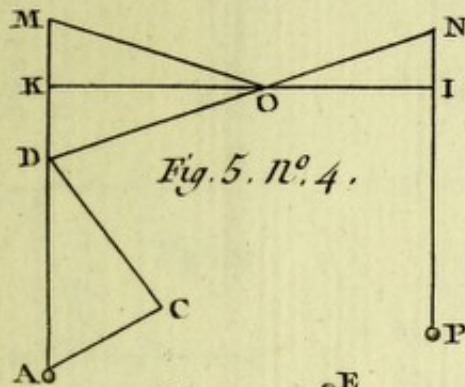
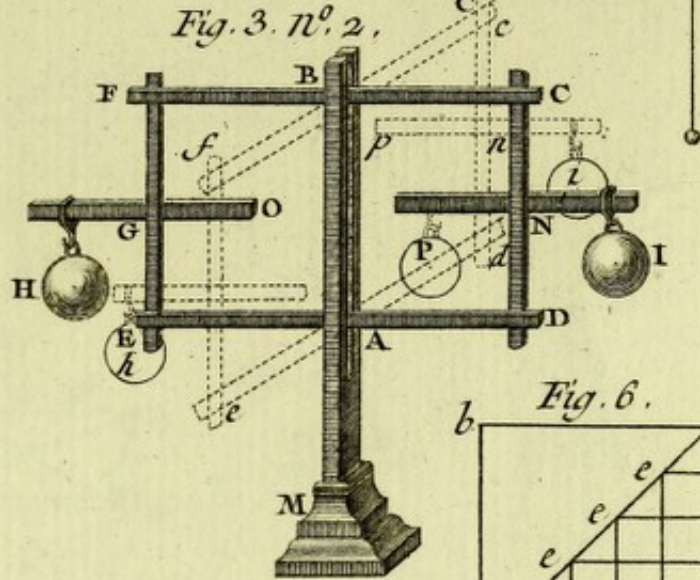
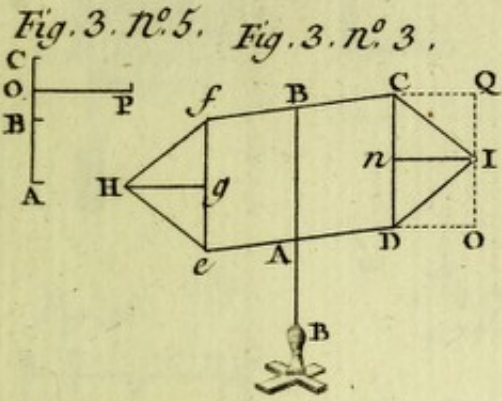
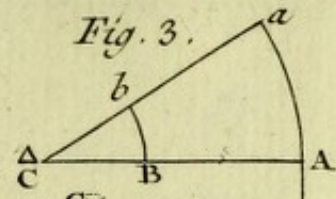
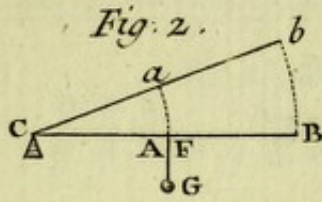
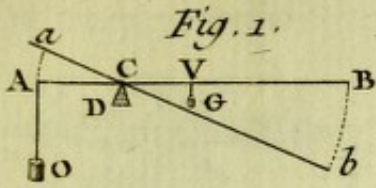
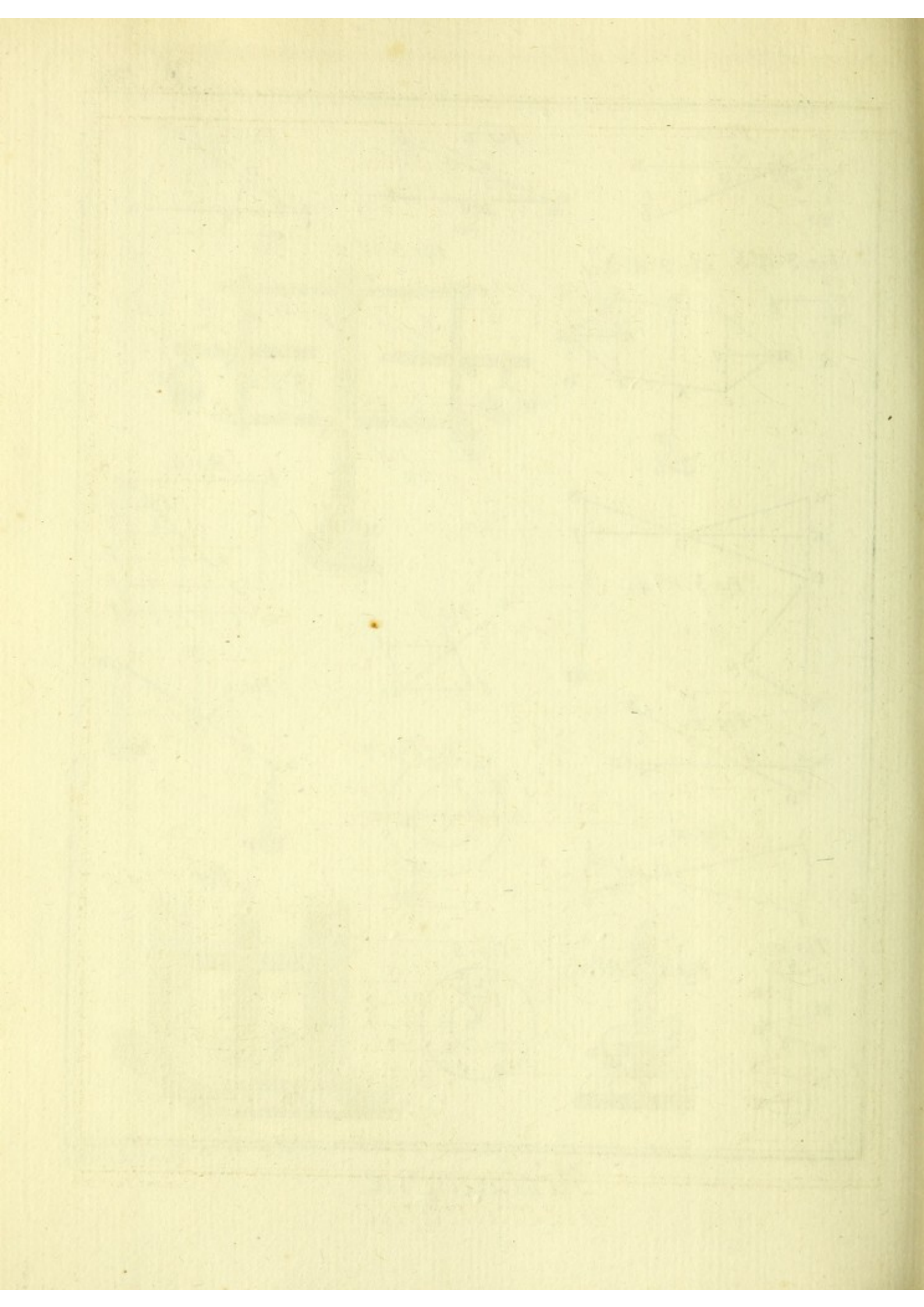


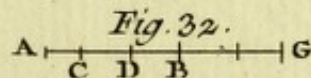
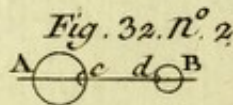
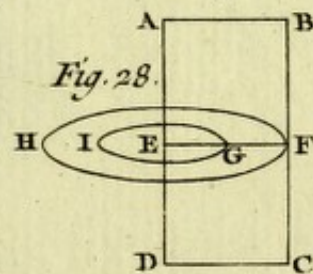
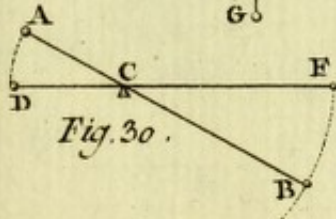
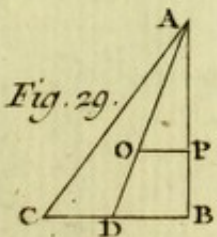
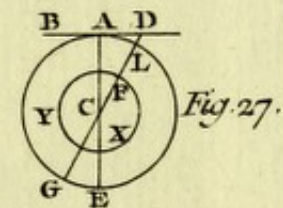
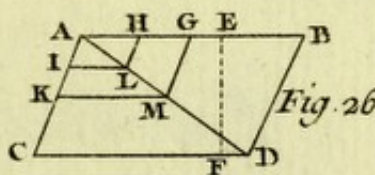
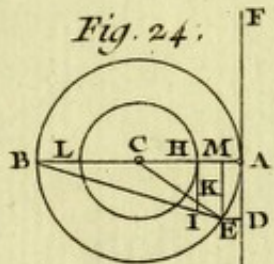
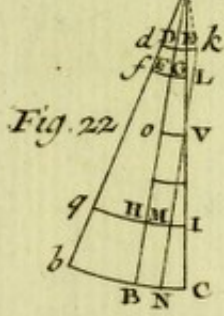
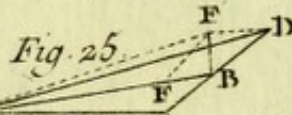
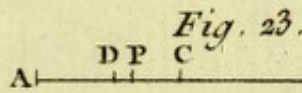
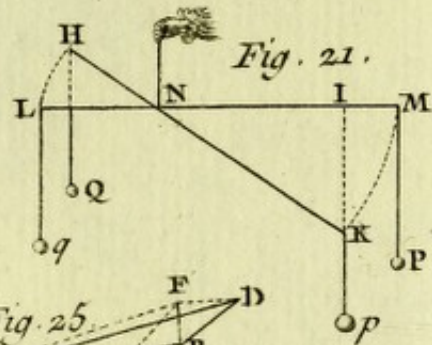
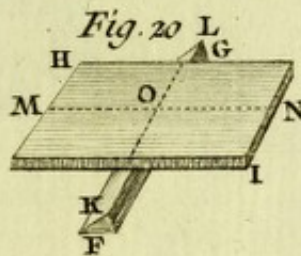
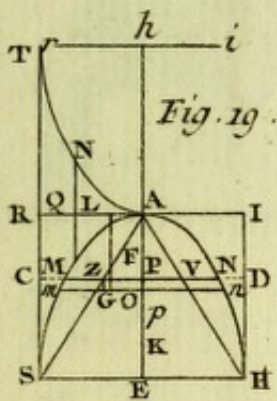
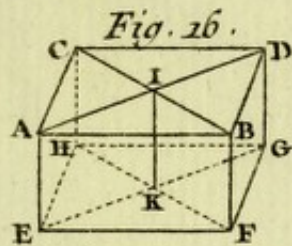
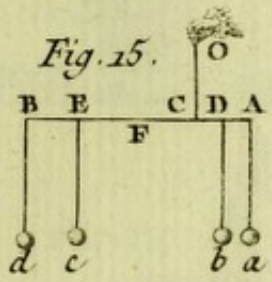
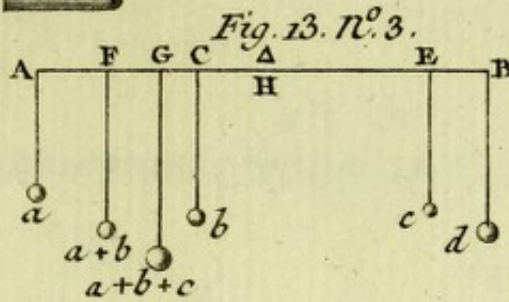
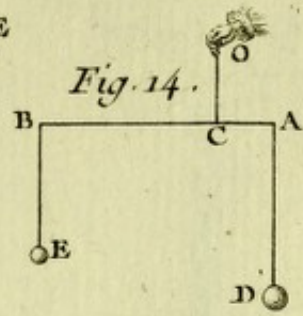
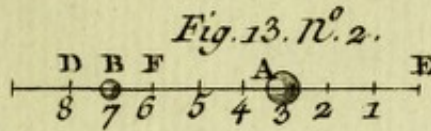
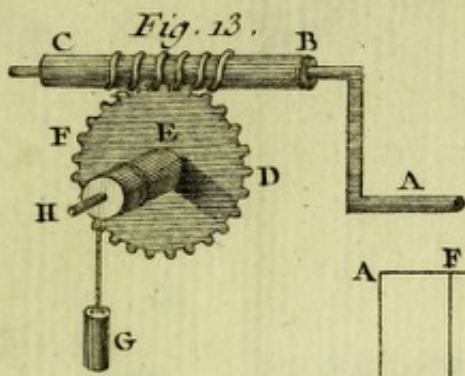
Fig. 3.











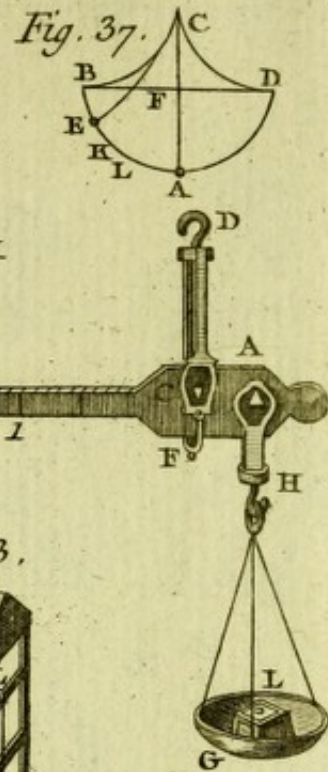
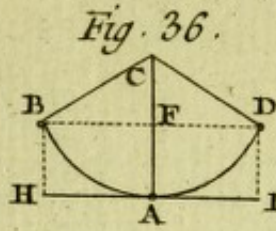
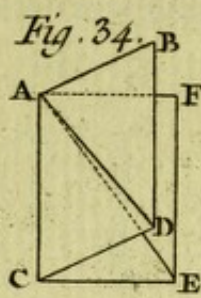
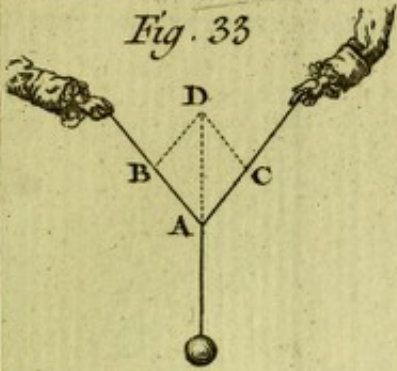


Fig. 38.

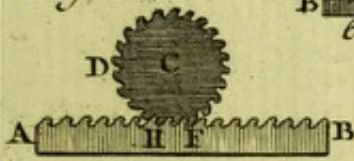


Fig. 35.

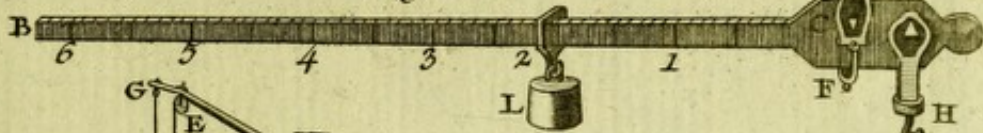


Fig. 39.

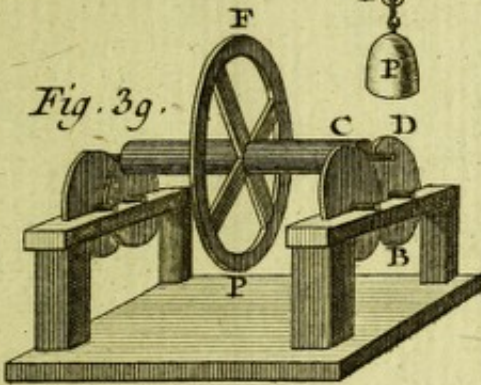


Fig. 39. N. 3.

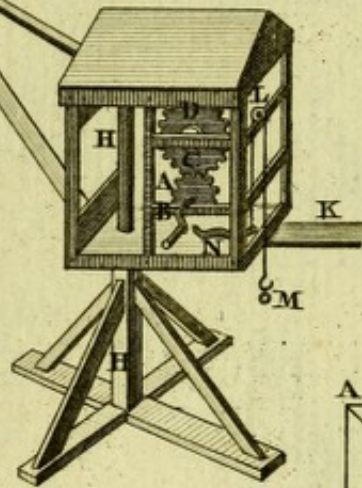


Fig. 41.

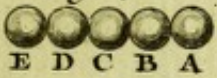


Fig. 40.

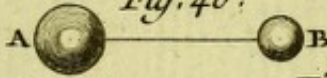


Fig. 39. N. 2.

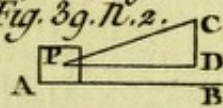


Fig. 42.

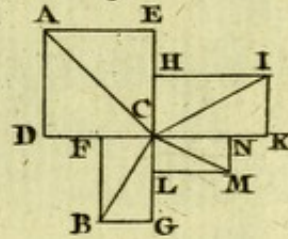


Fig. 43.

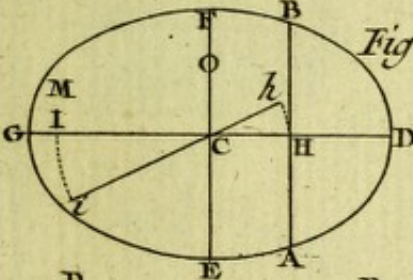


Fig. 44.

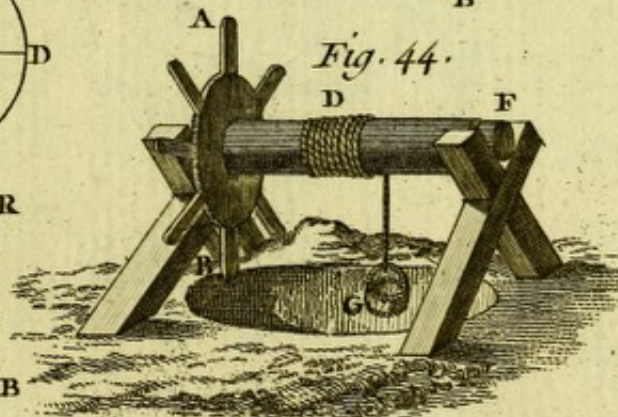


Fig. 46.

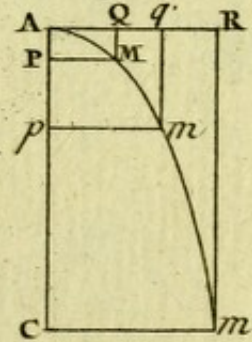


Fig. 47.

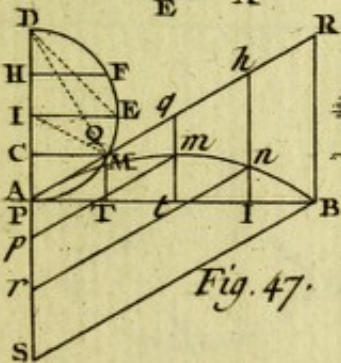
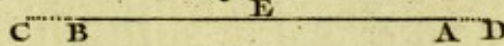
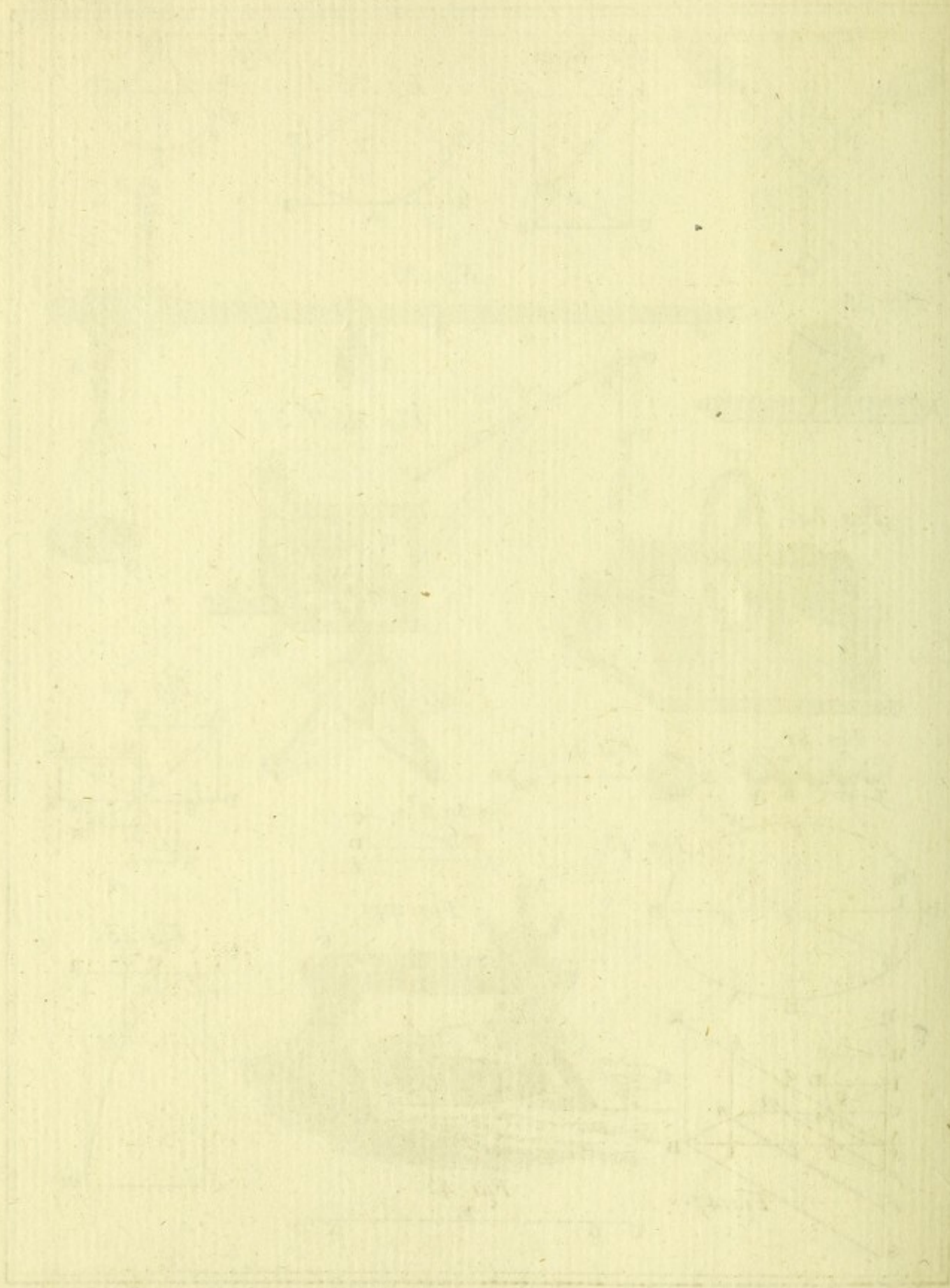
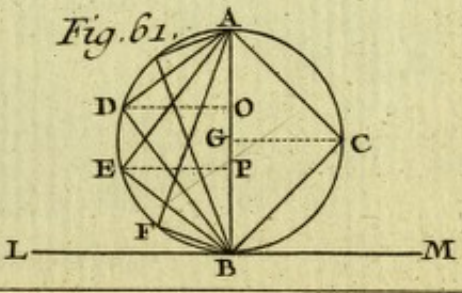
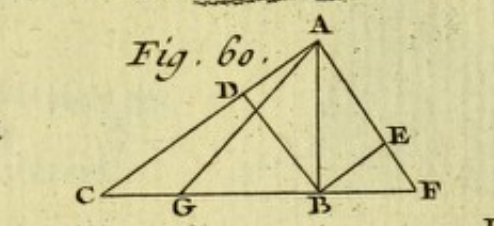
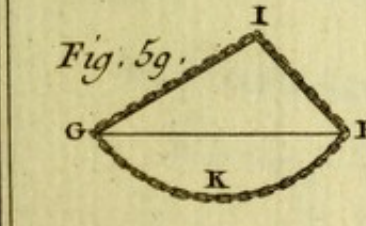
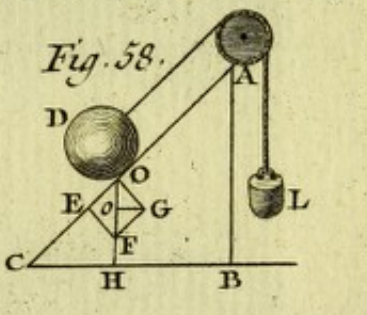
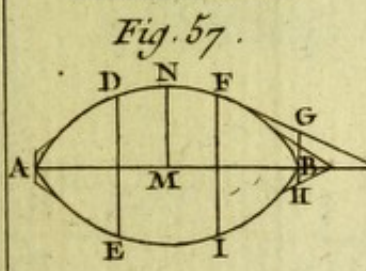
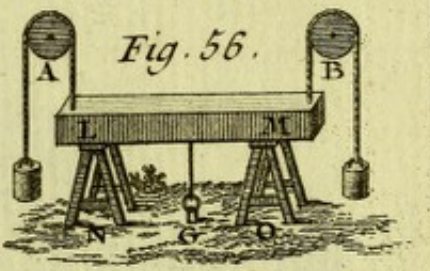
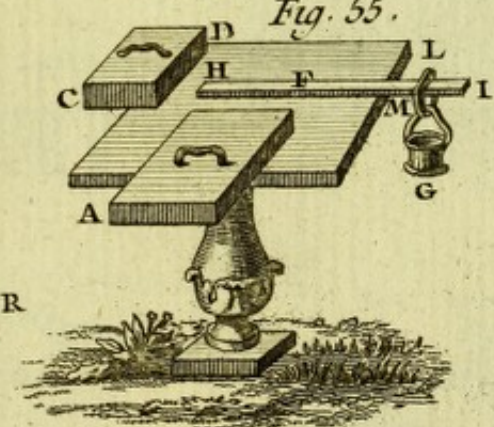
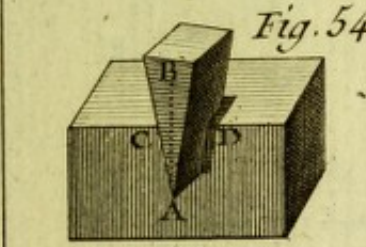
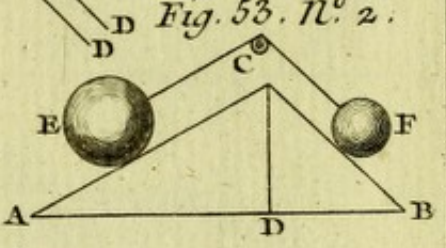
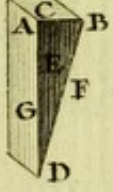
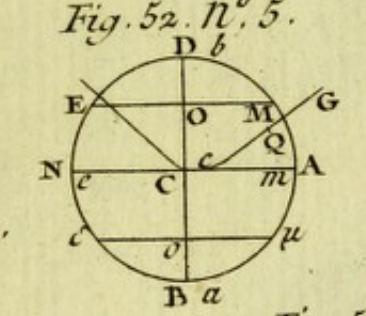
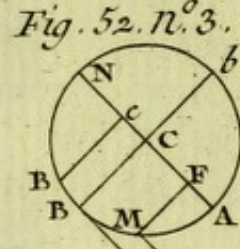
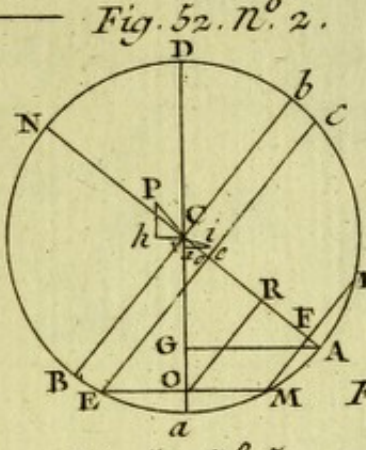
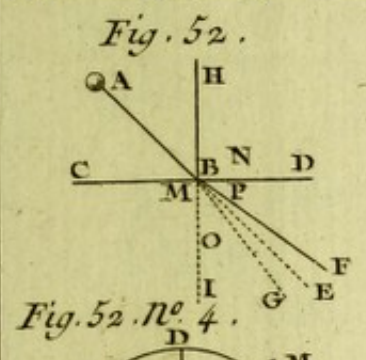
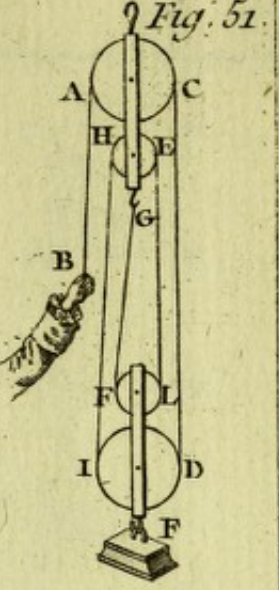
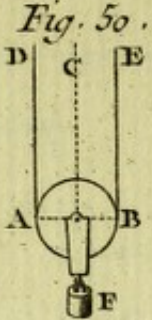
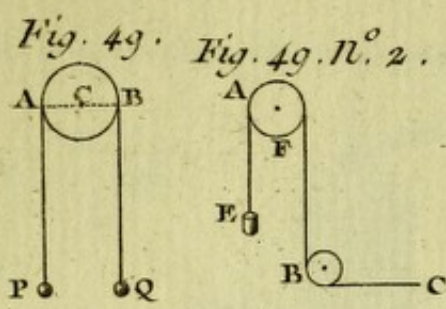
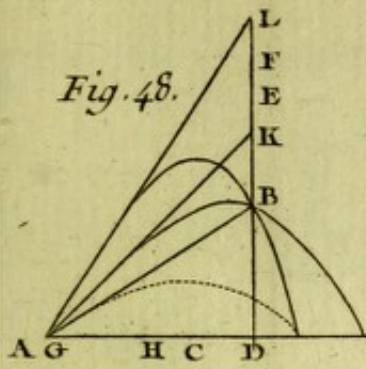


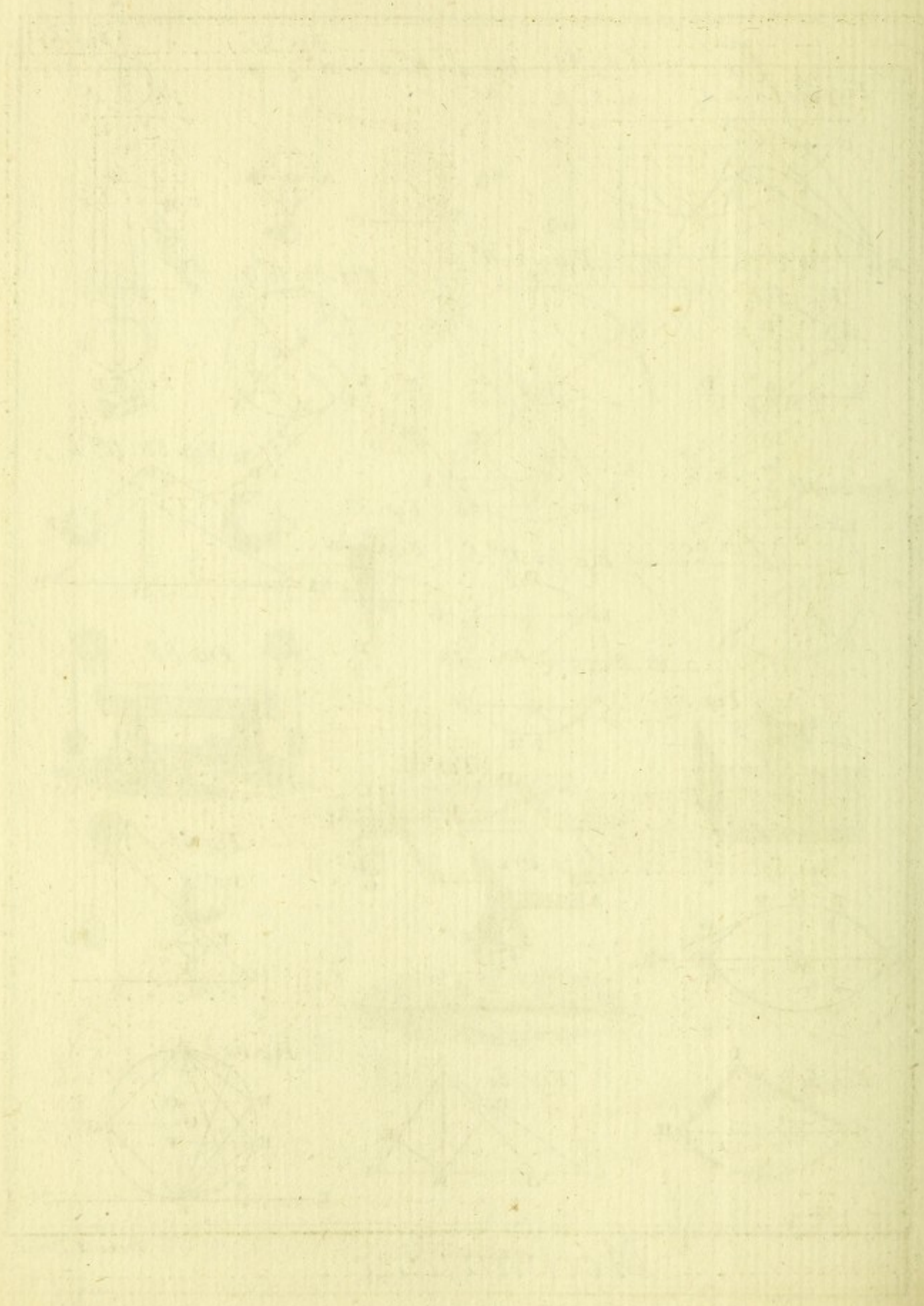
Fig. 45.

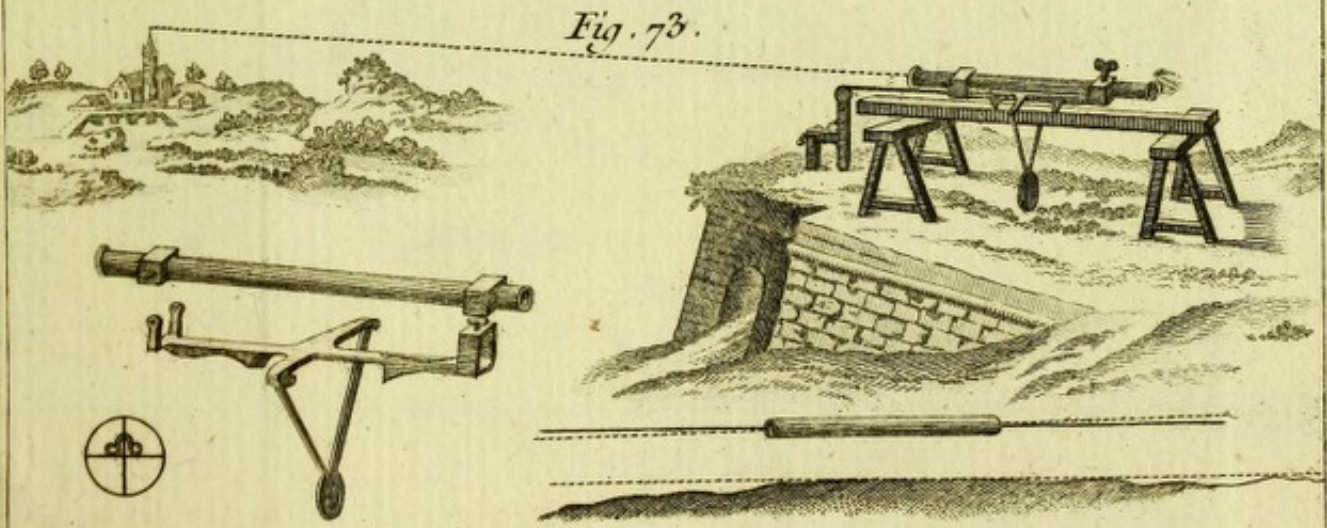
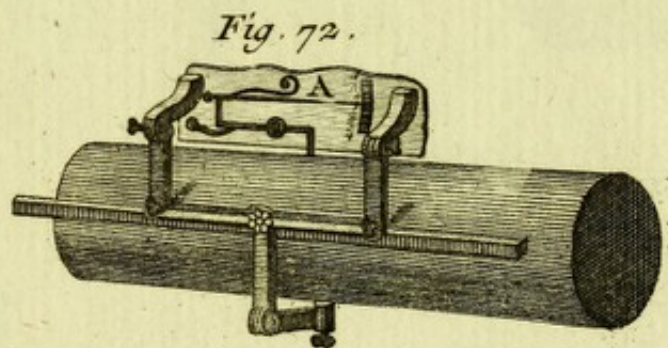
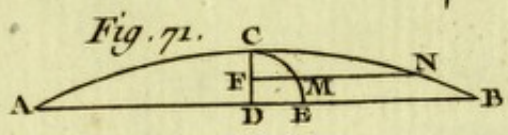
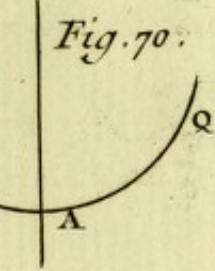
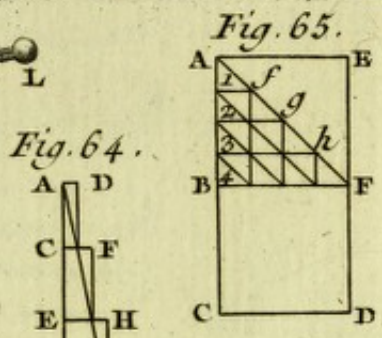
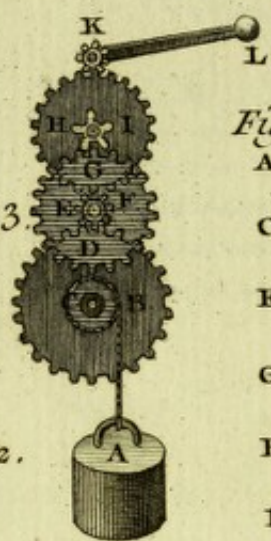
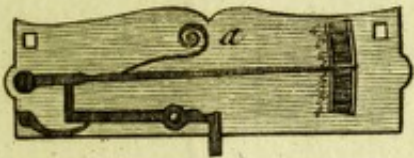
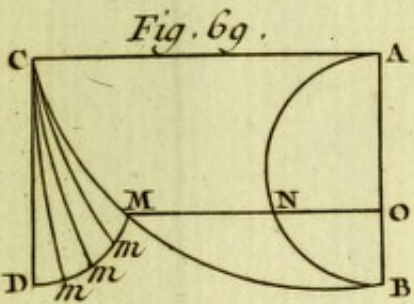
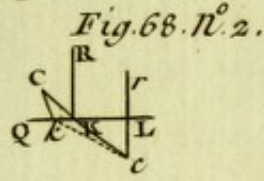
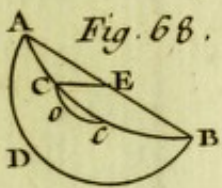
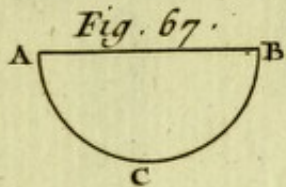
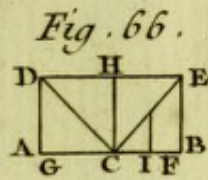
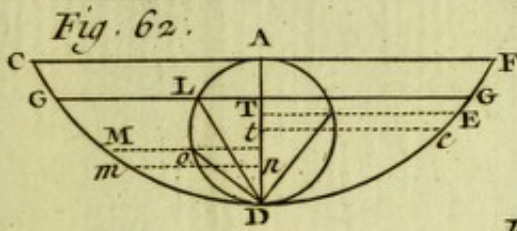




Aluminum







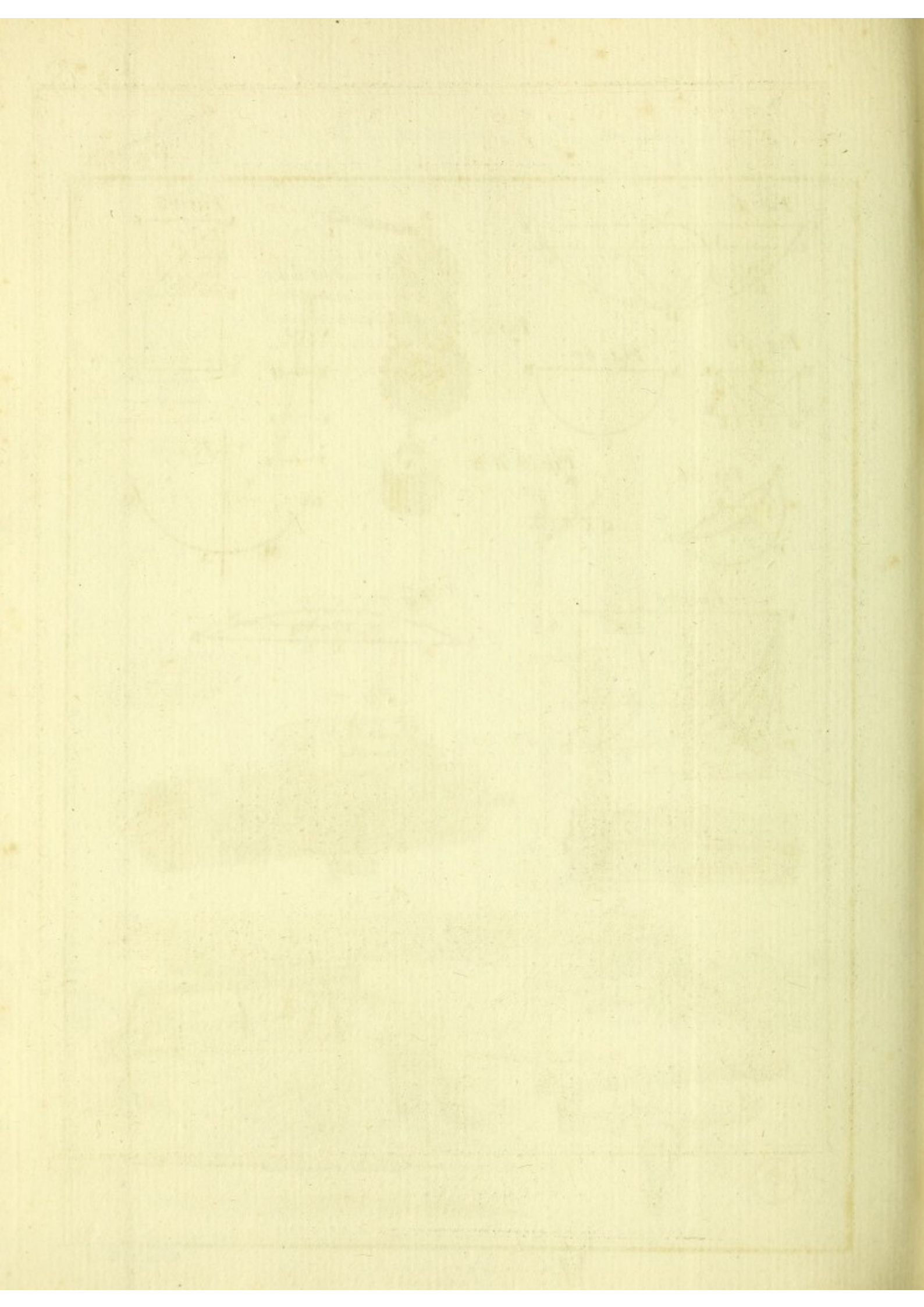


Fig. 1.

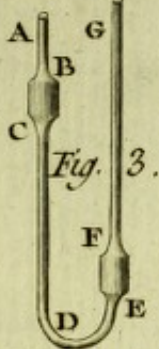


Fig. 5. n. 2.



Fig. 5.

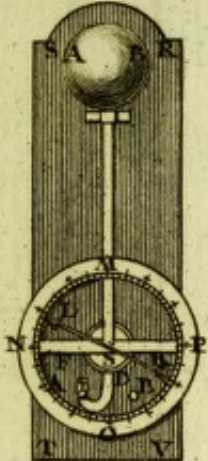


Fig. 3. n. 2.

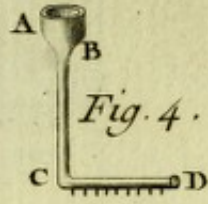


Fig. 4.

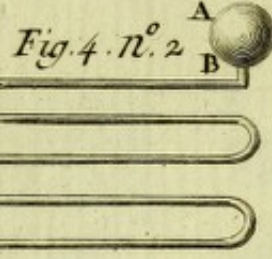


Fig. 4. n. 2.

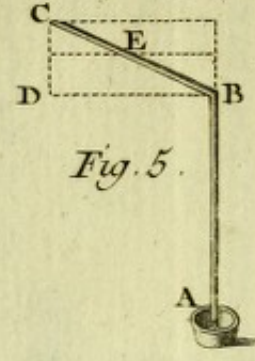


Fig. 5.

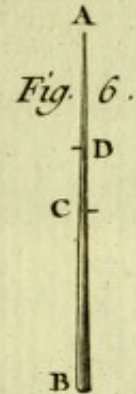


Fig. 6.

Fig. 6. n. 2.

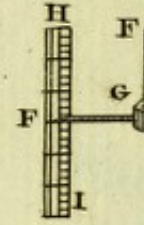


Fig. 7.

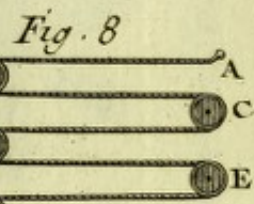


Fig. 8.



Fig. 9.

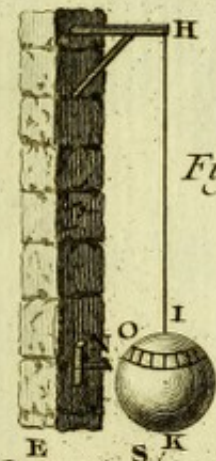


Fig. 10.

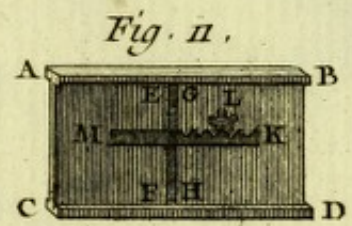


Fig. 11.

Fig. 14.

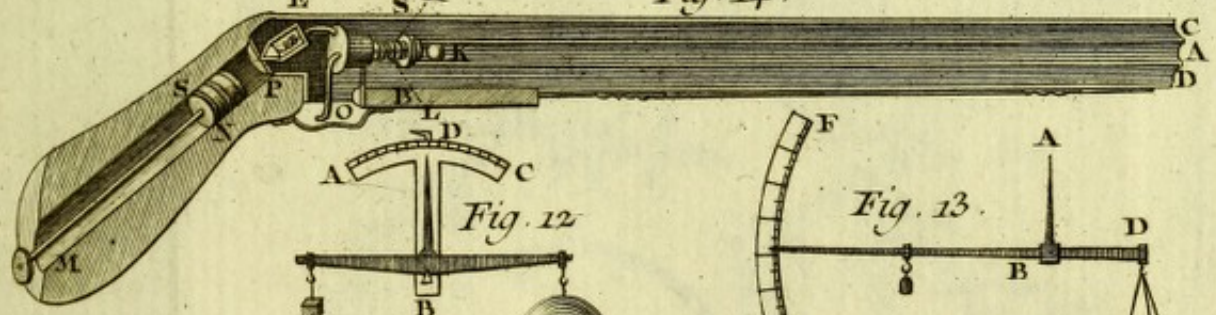


Fig. 12.

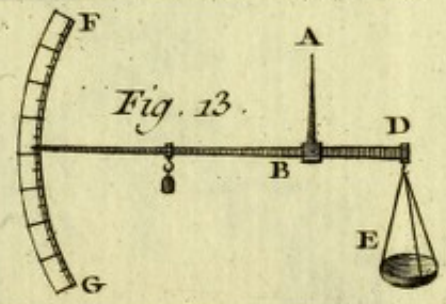
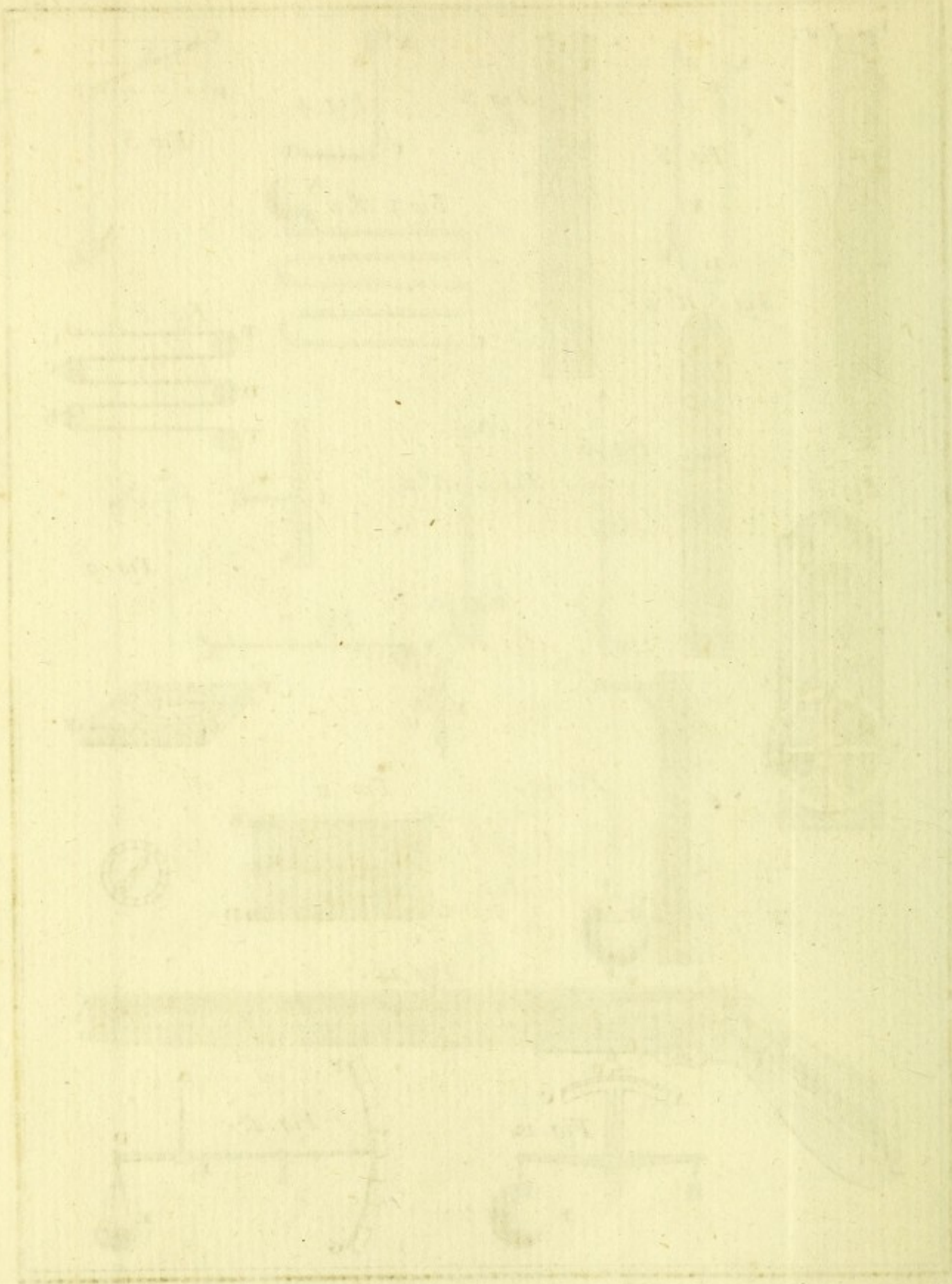
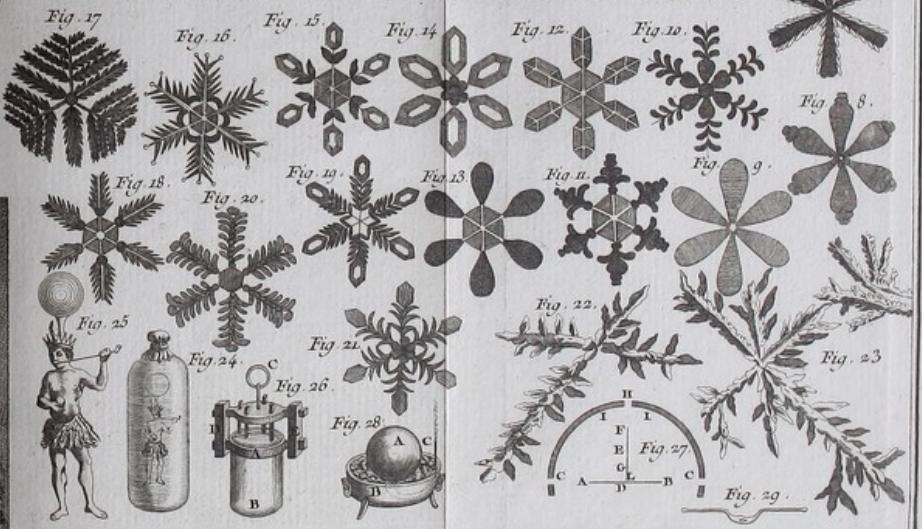
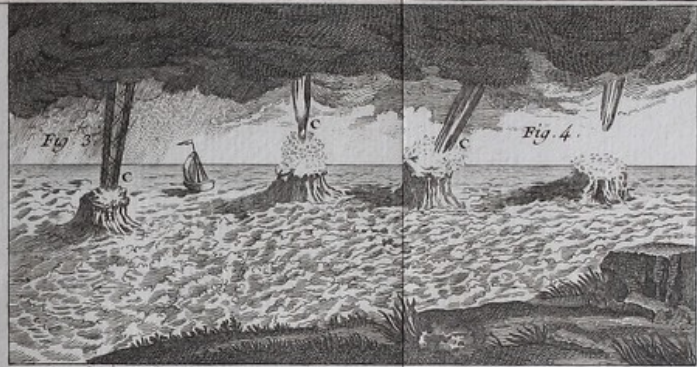
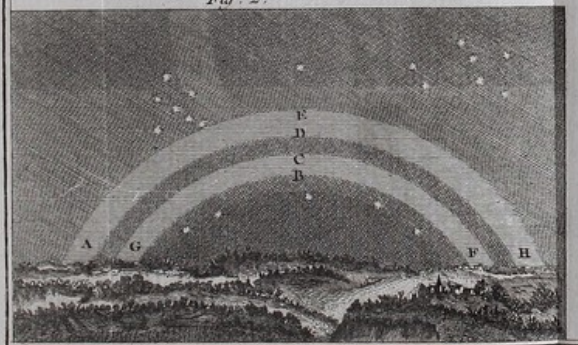


Fig. 13.

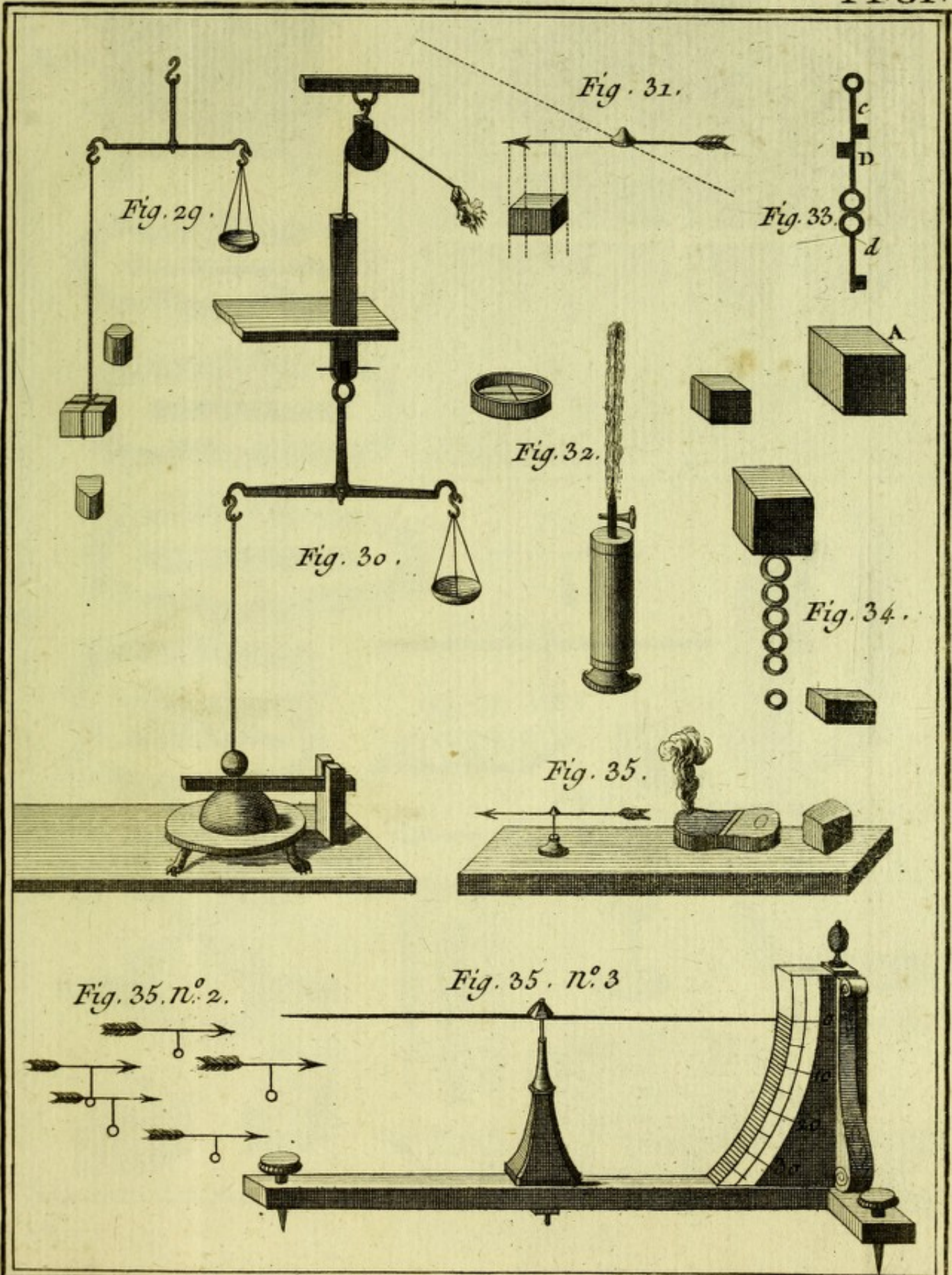


Vertical Shaft



Physique.

Bernard Drex

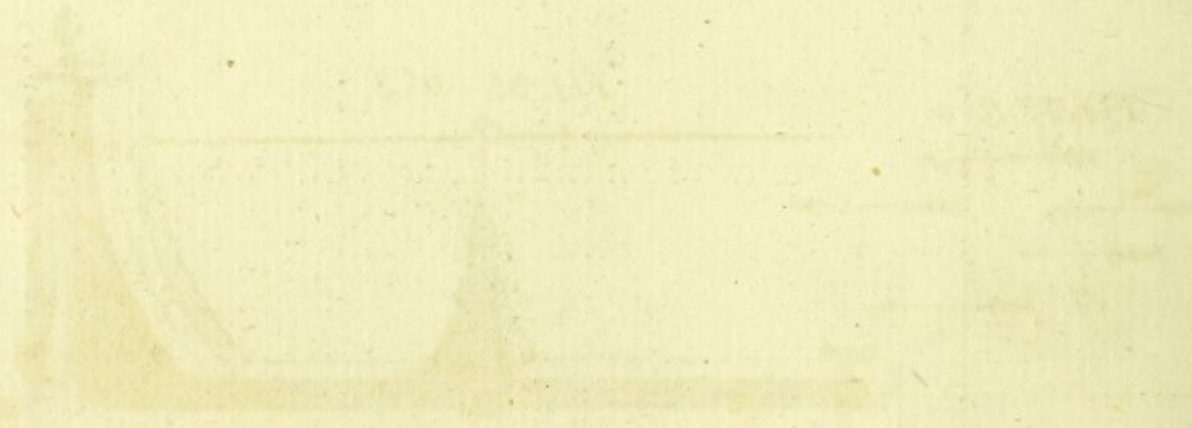


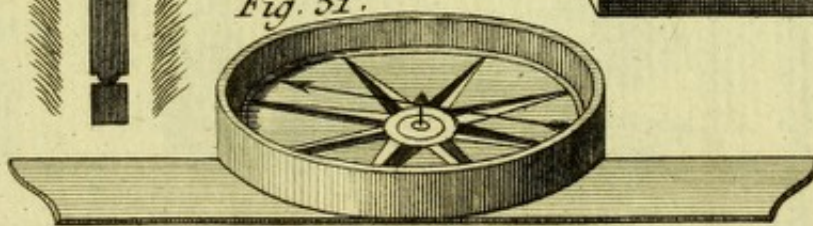
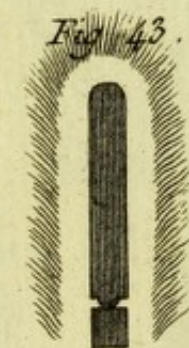
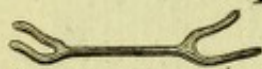
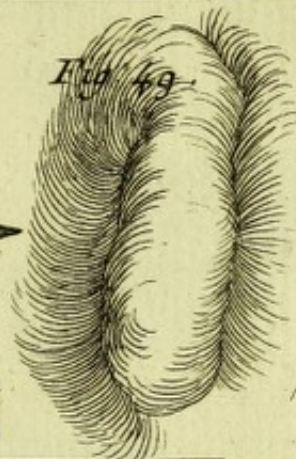
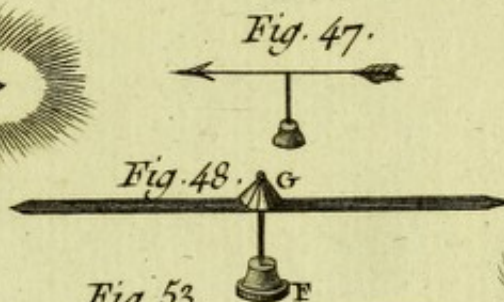
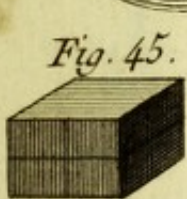
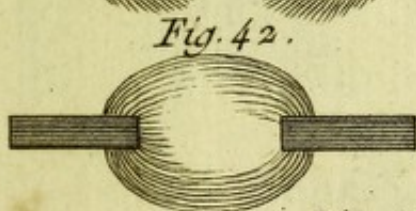
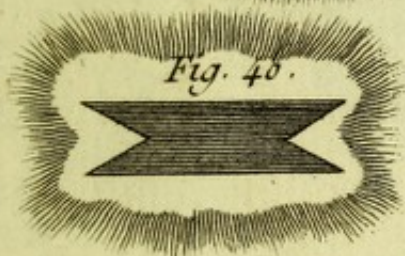
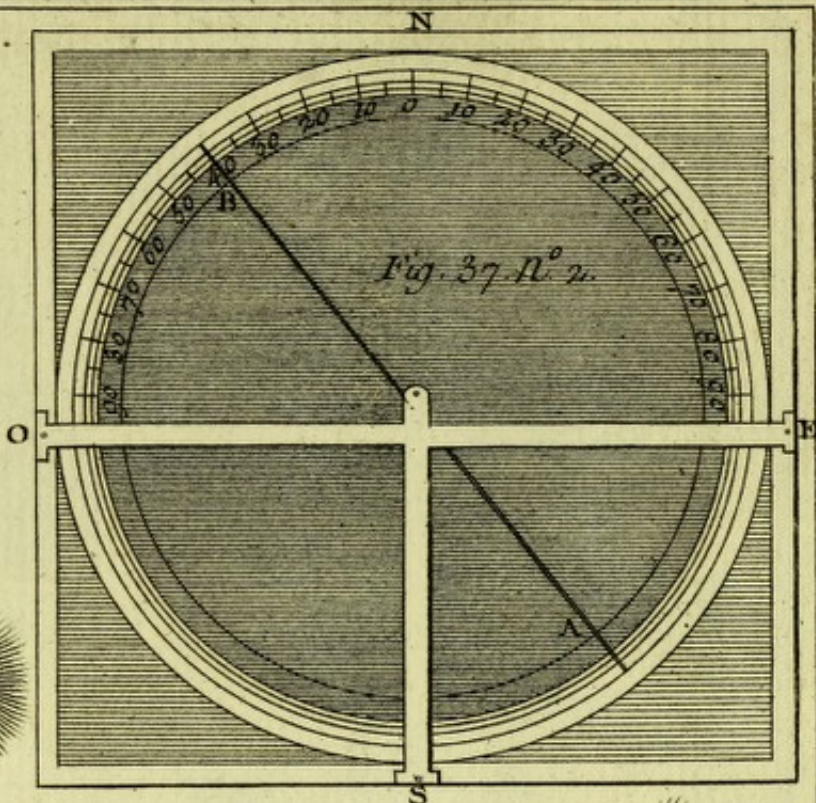
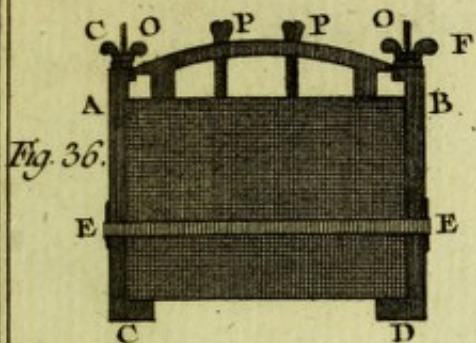
Vertical text on the left side of the page, possibly a page number or title.

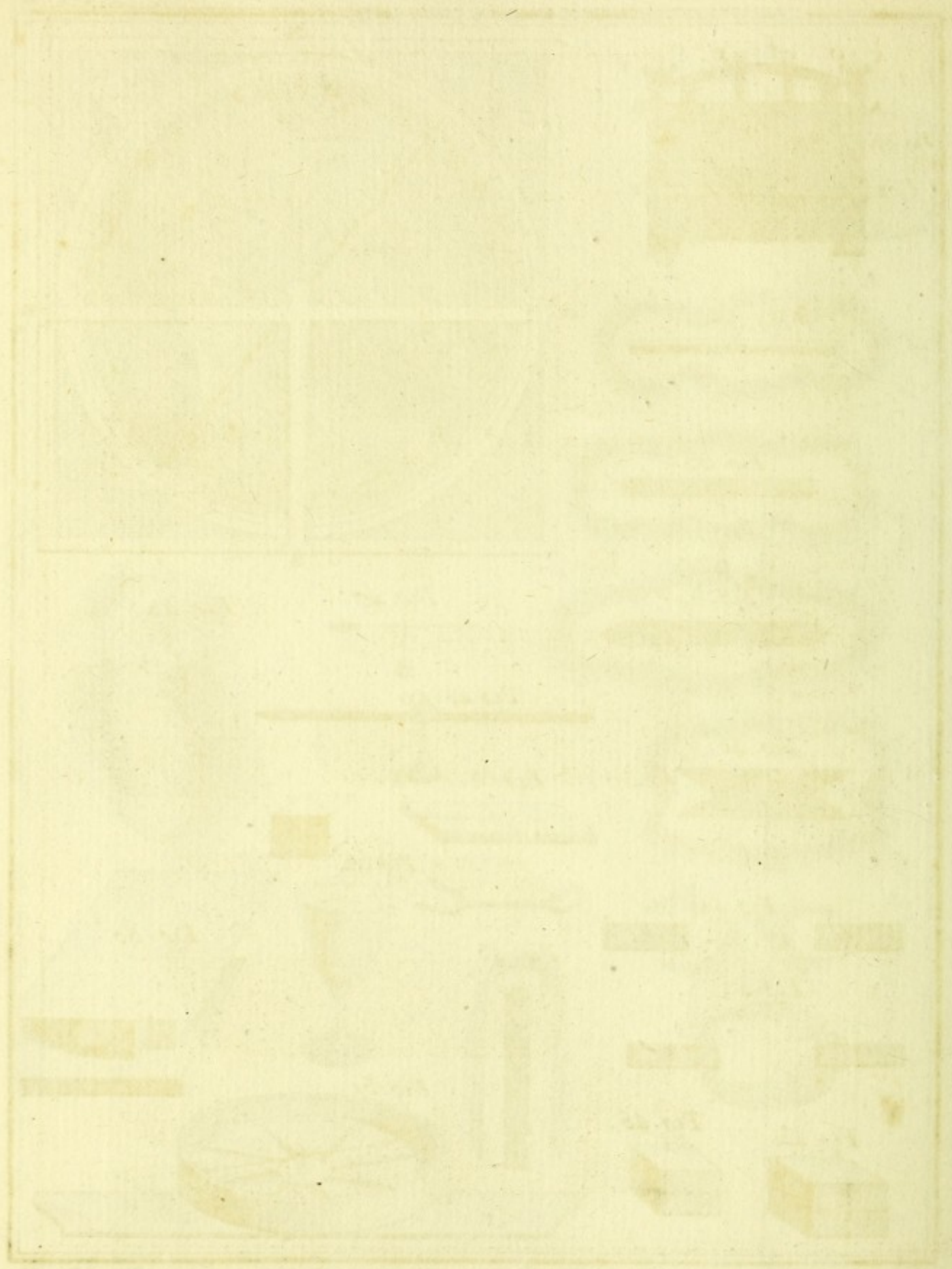
Top center text, possibly a title or label.

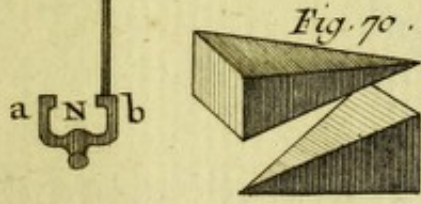
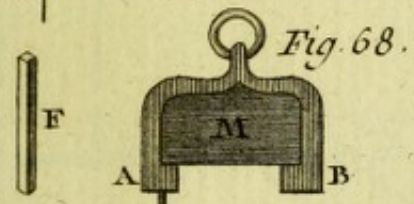
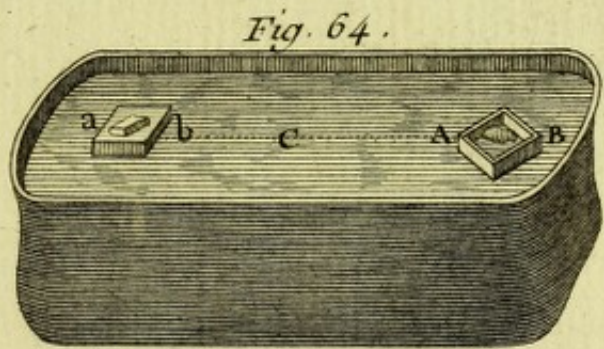
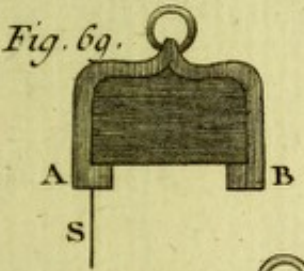
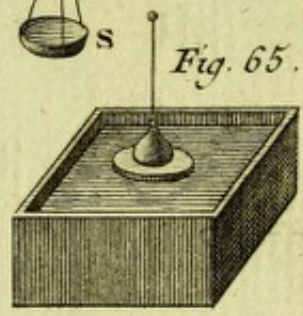
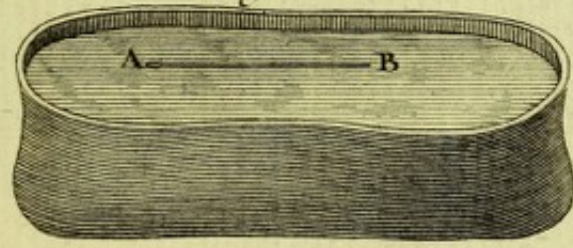
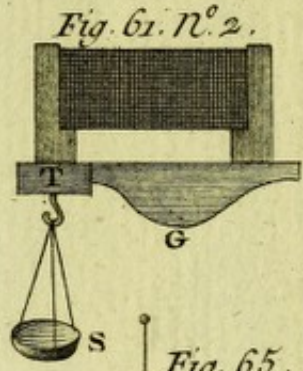
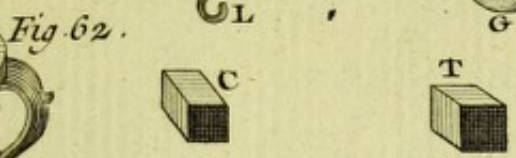
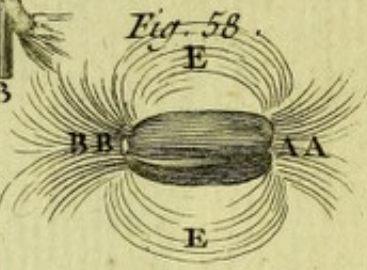
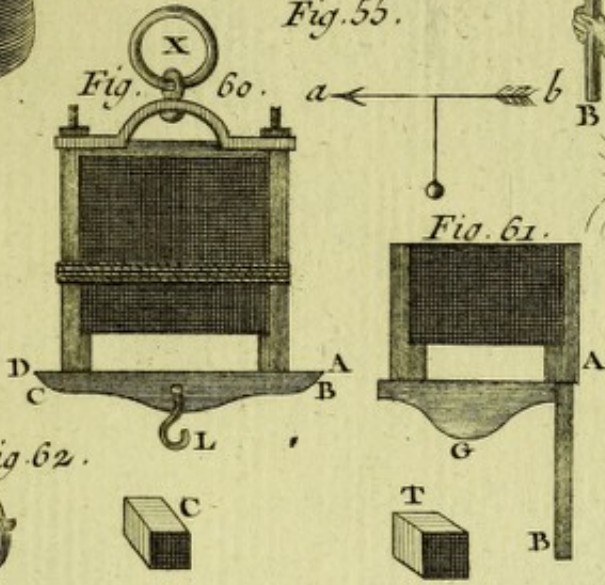
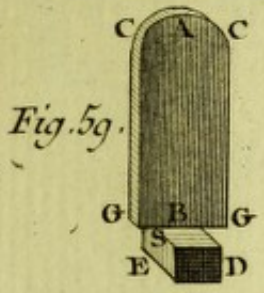
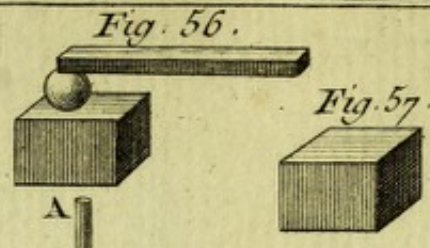
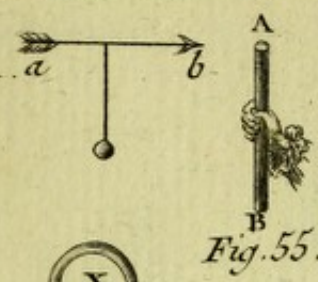
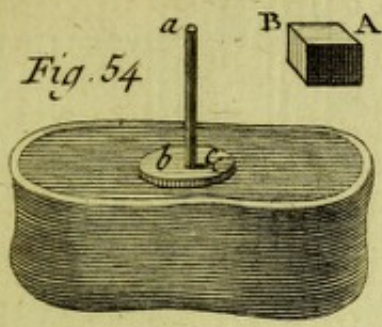
Top right text, possibly a title or label.

Vertical text on the left side, below the first section.









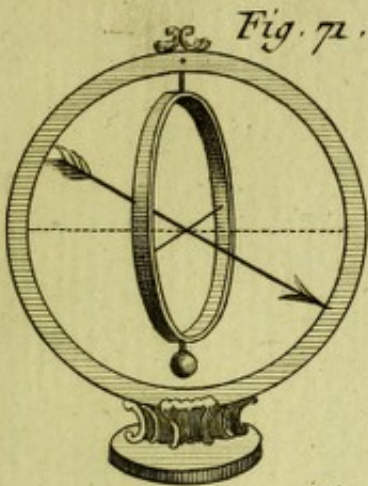


Fig. 72.

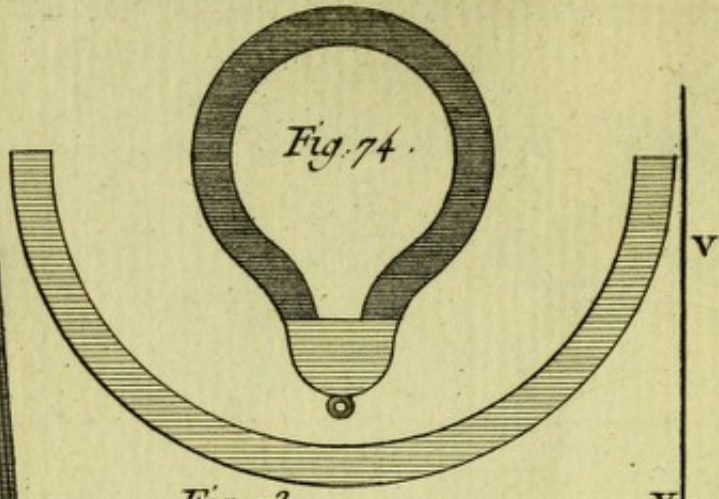


Fig. 74.

Fig. 72.

Fig. 73.

Fig. 77.

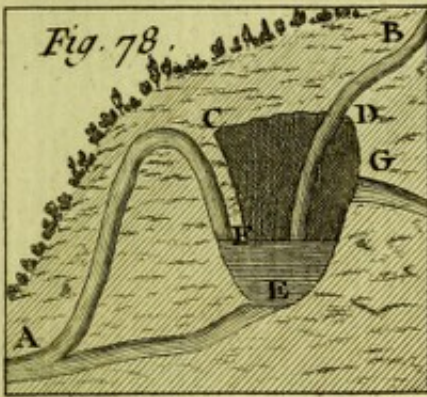


Fig. 78.

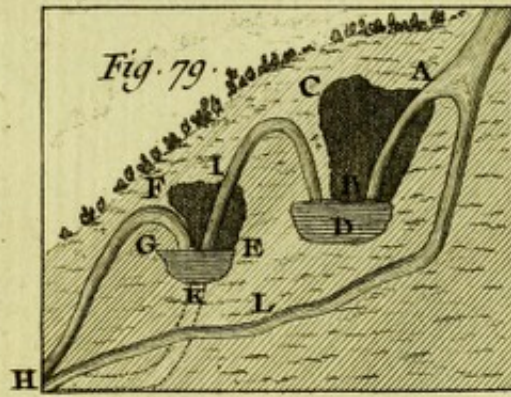


Fig. 79.

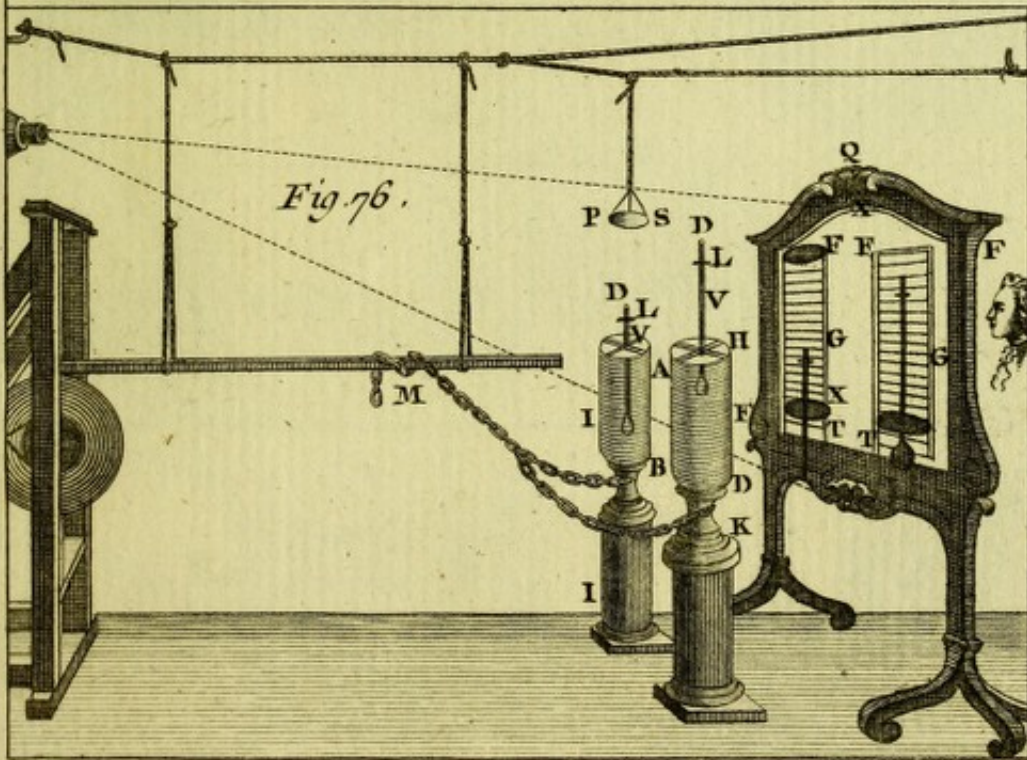
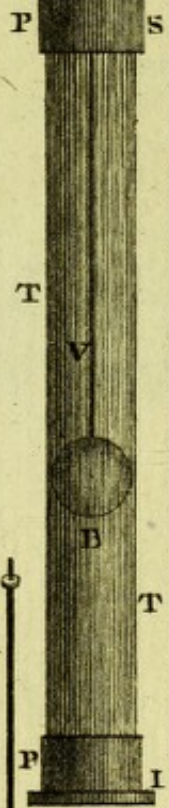


Fig. 76.

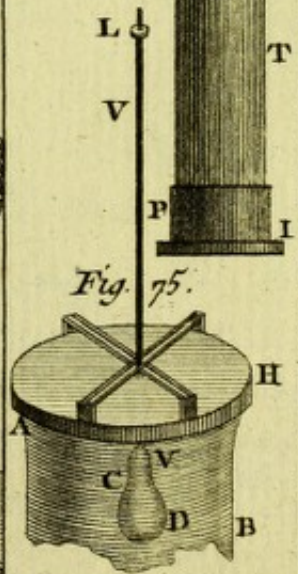
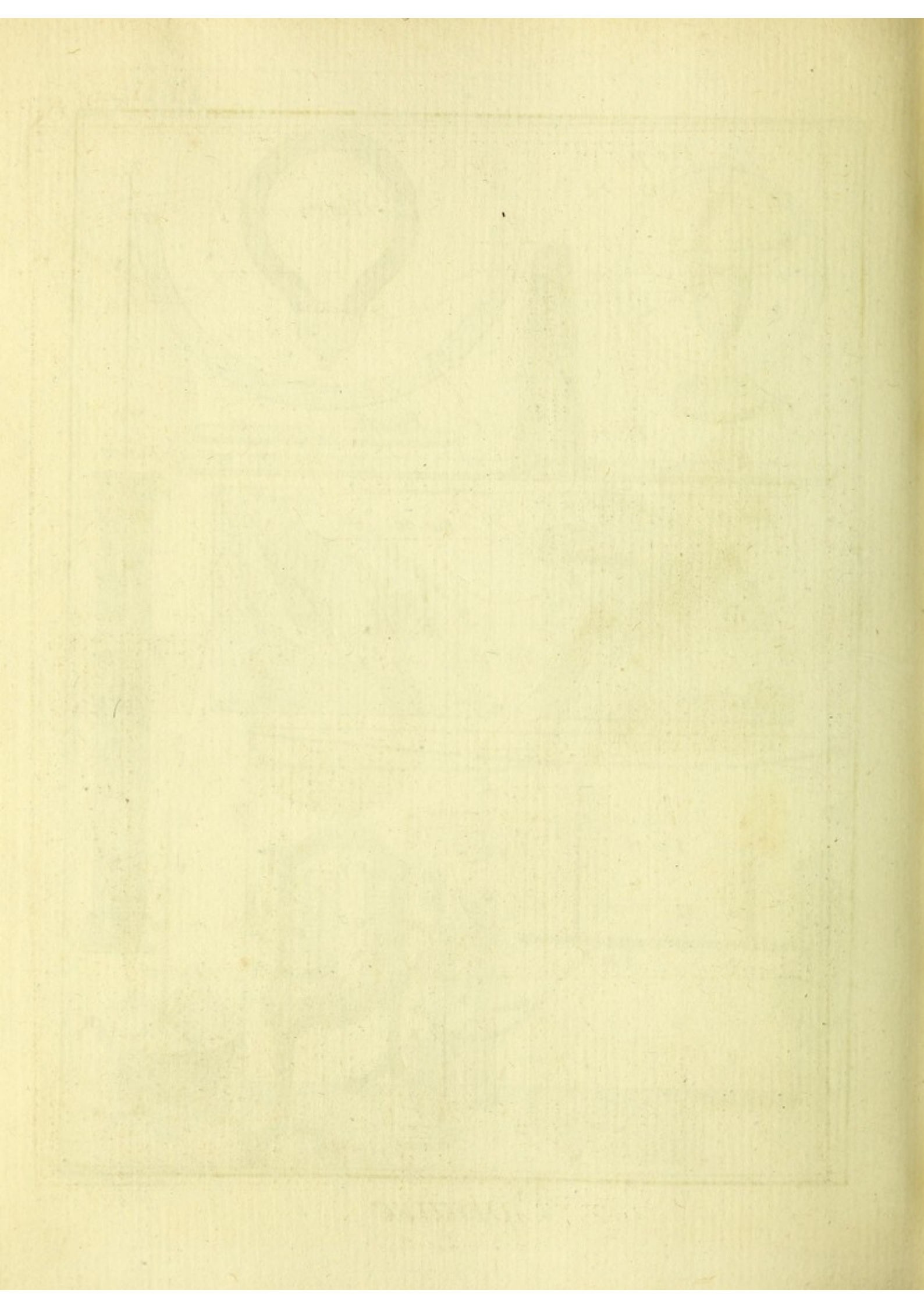
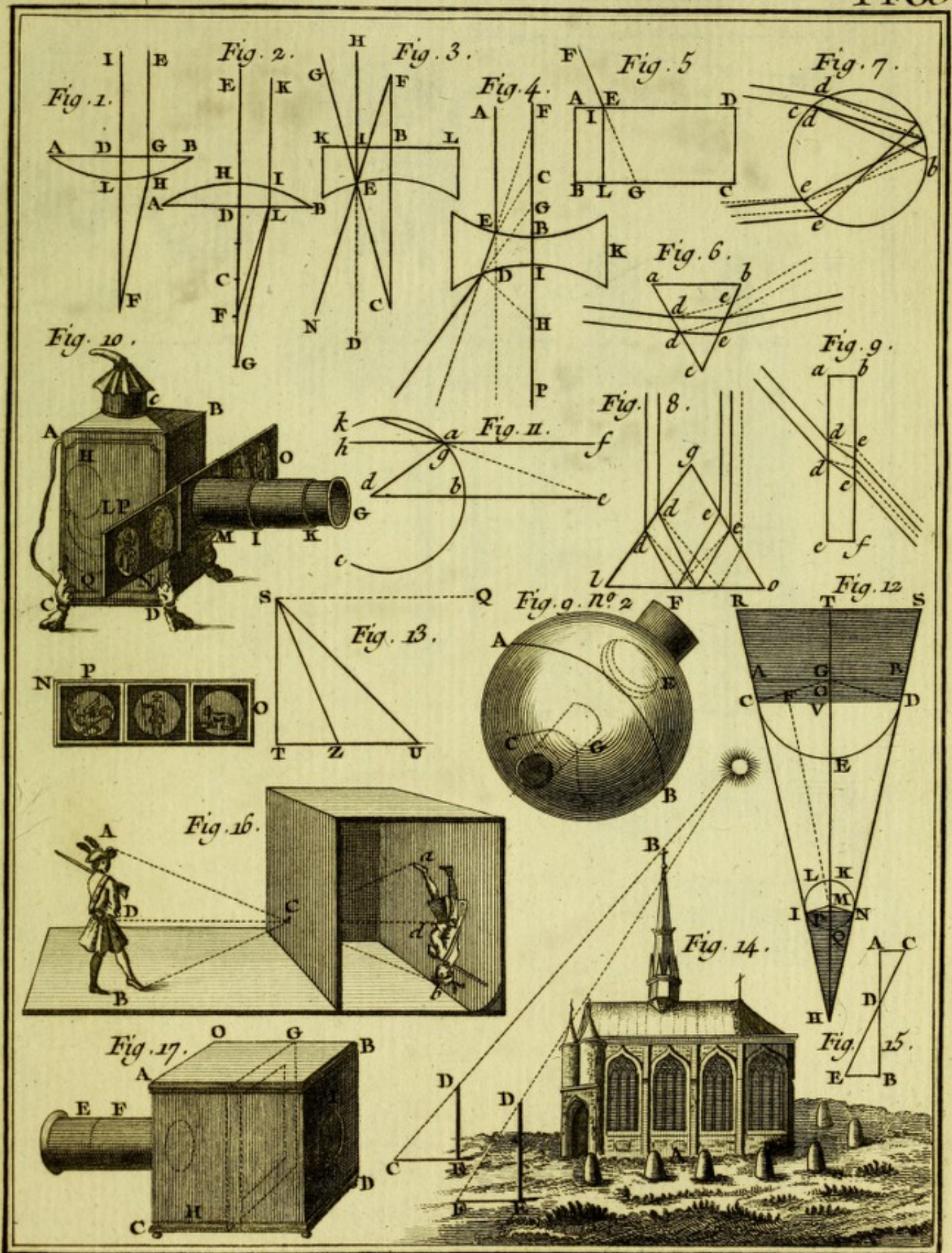


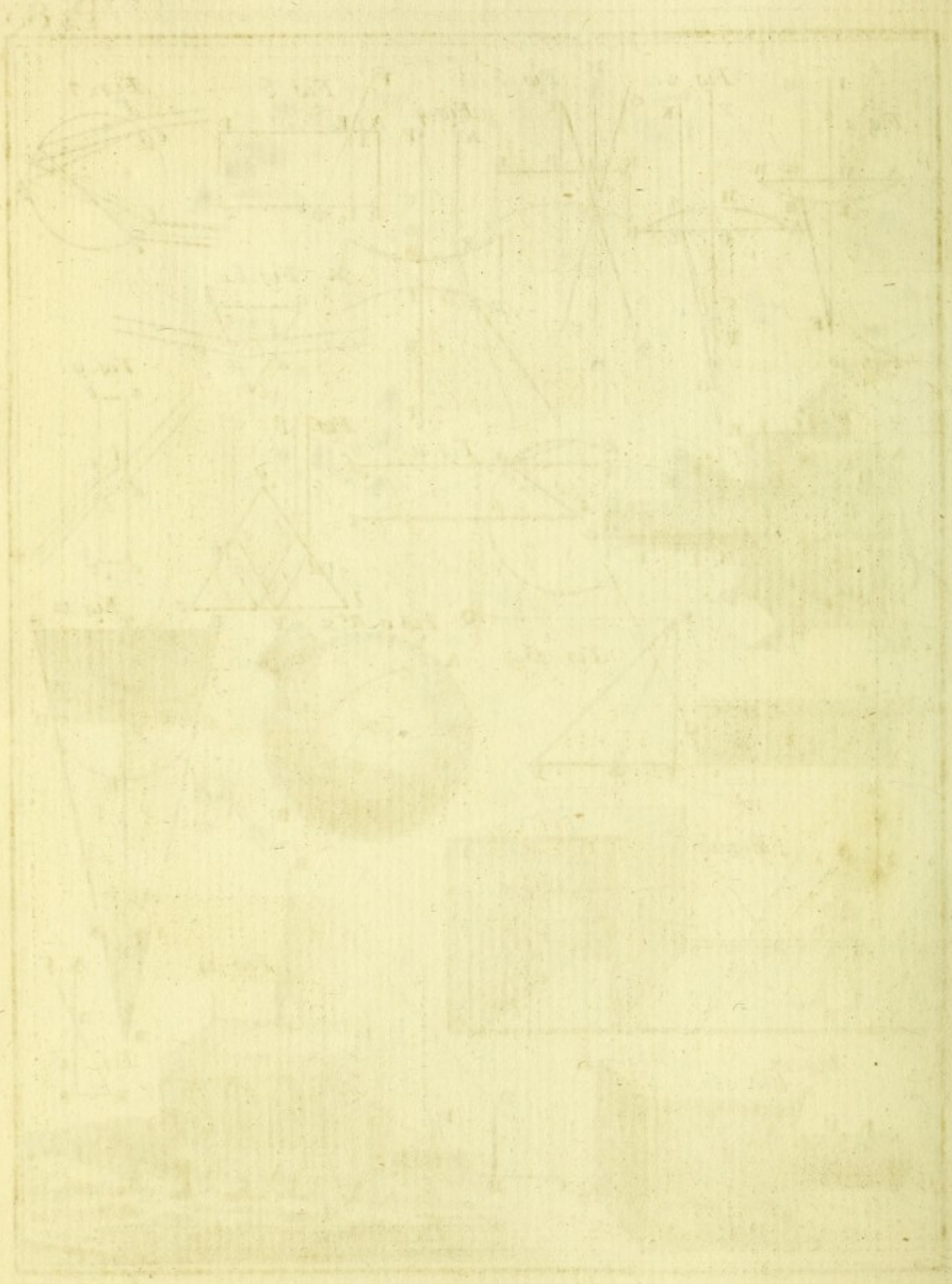
Fig. 75.

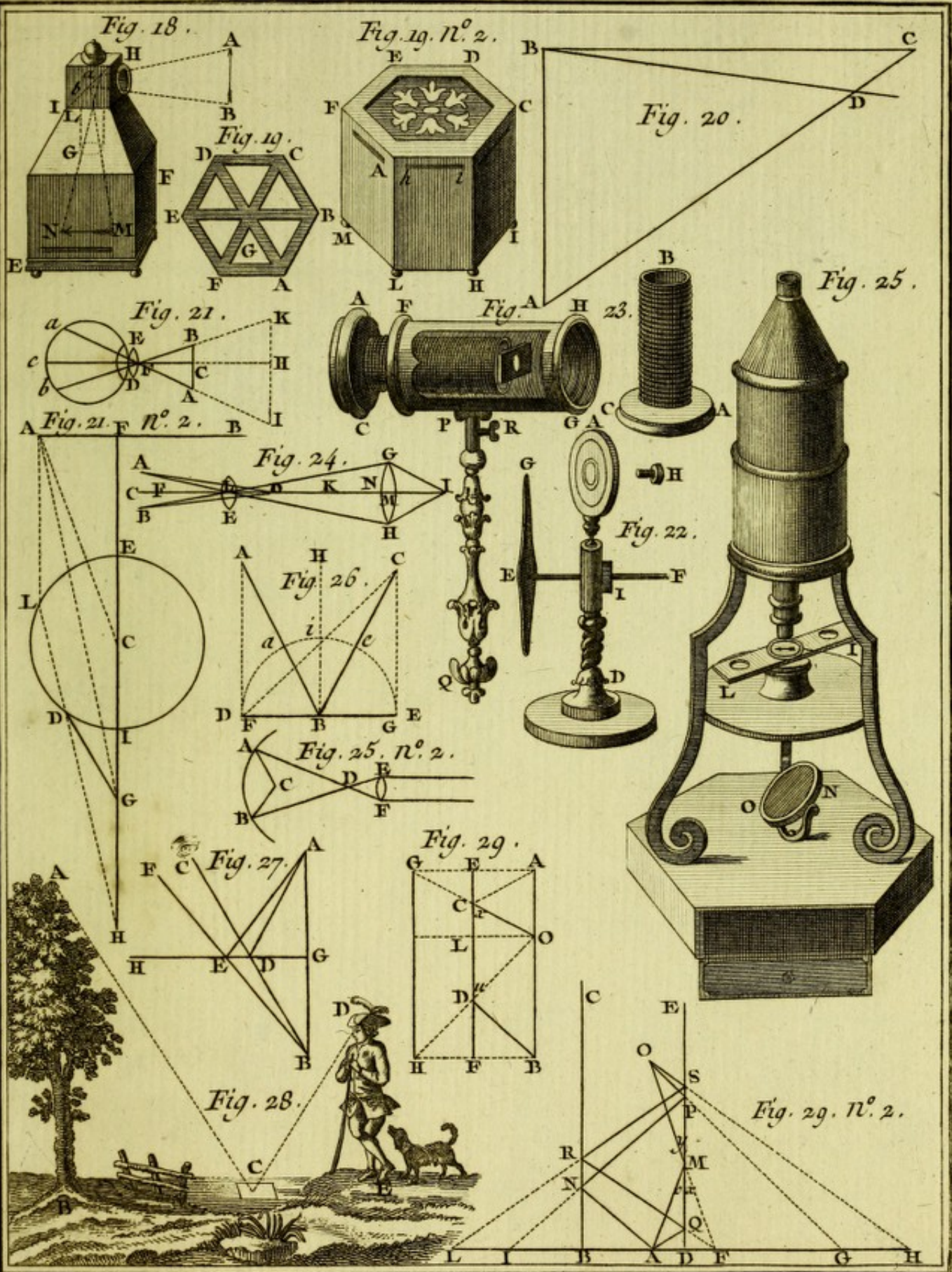




Optique.

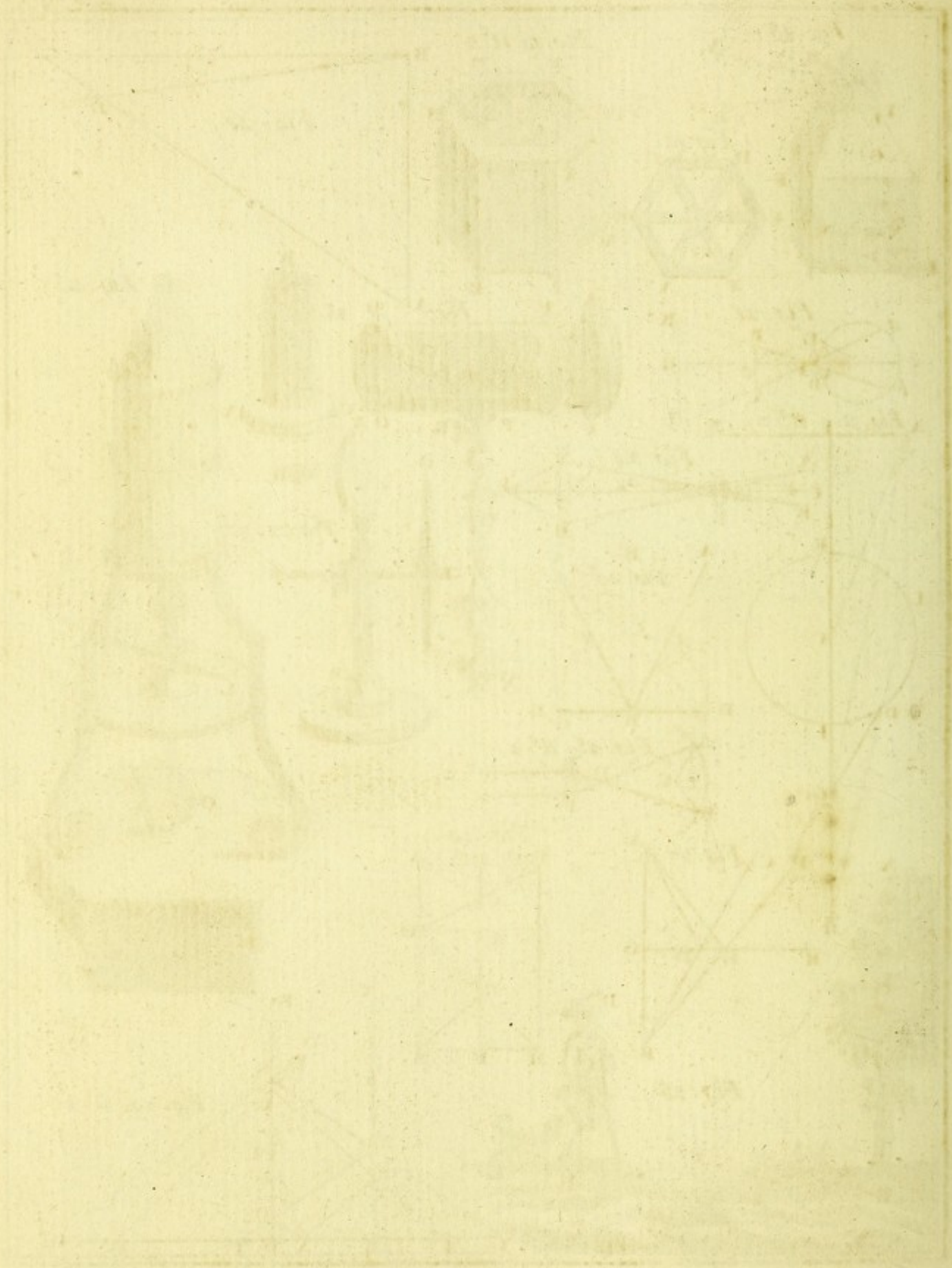
Benard Direr.

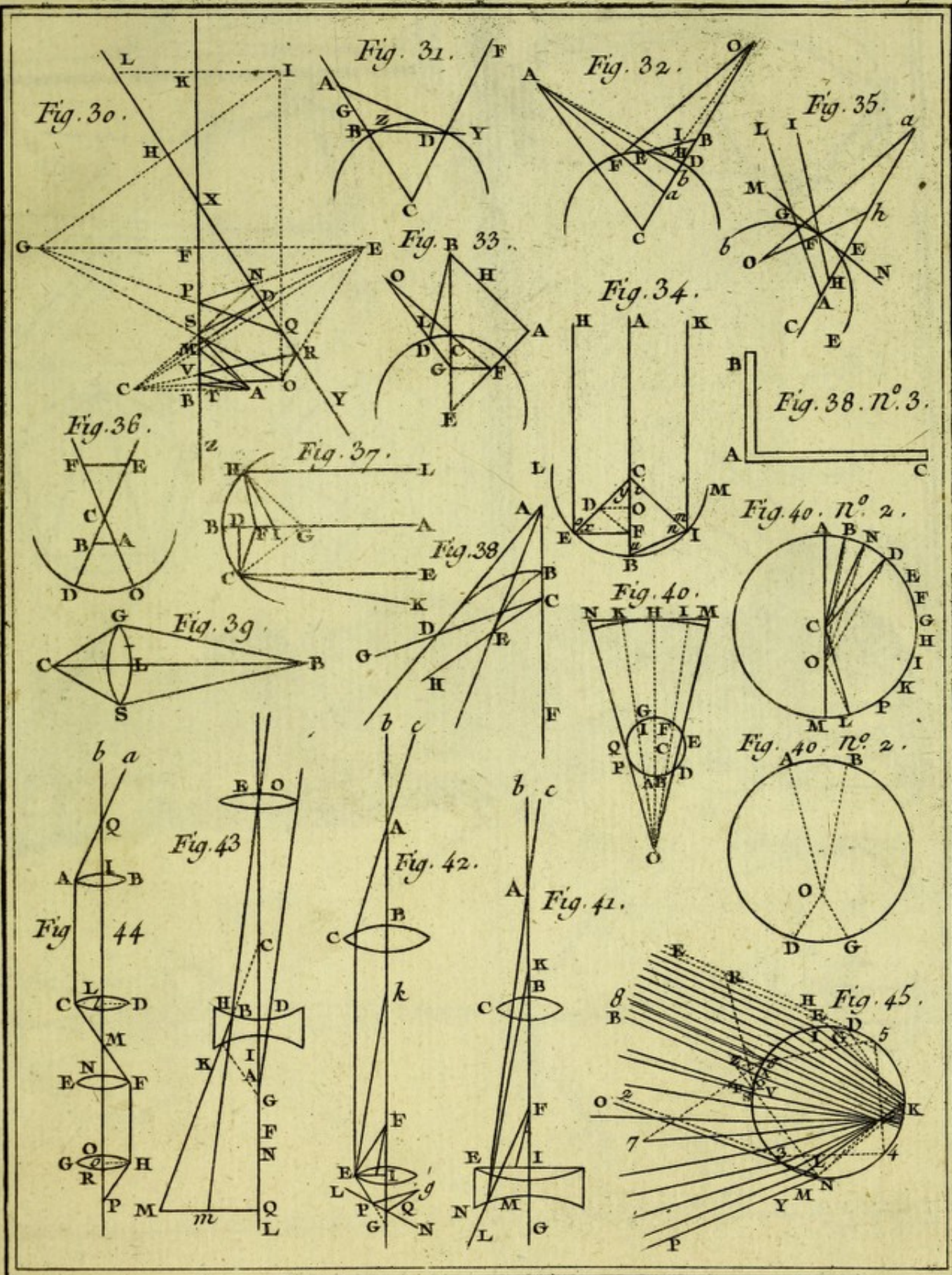


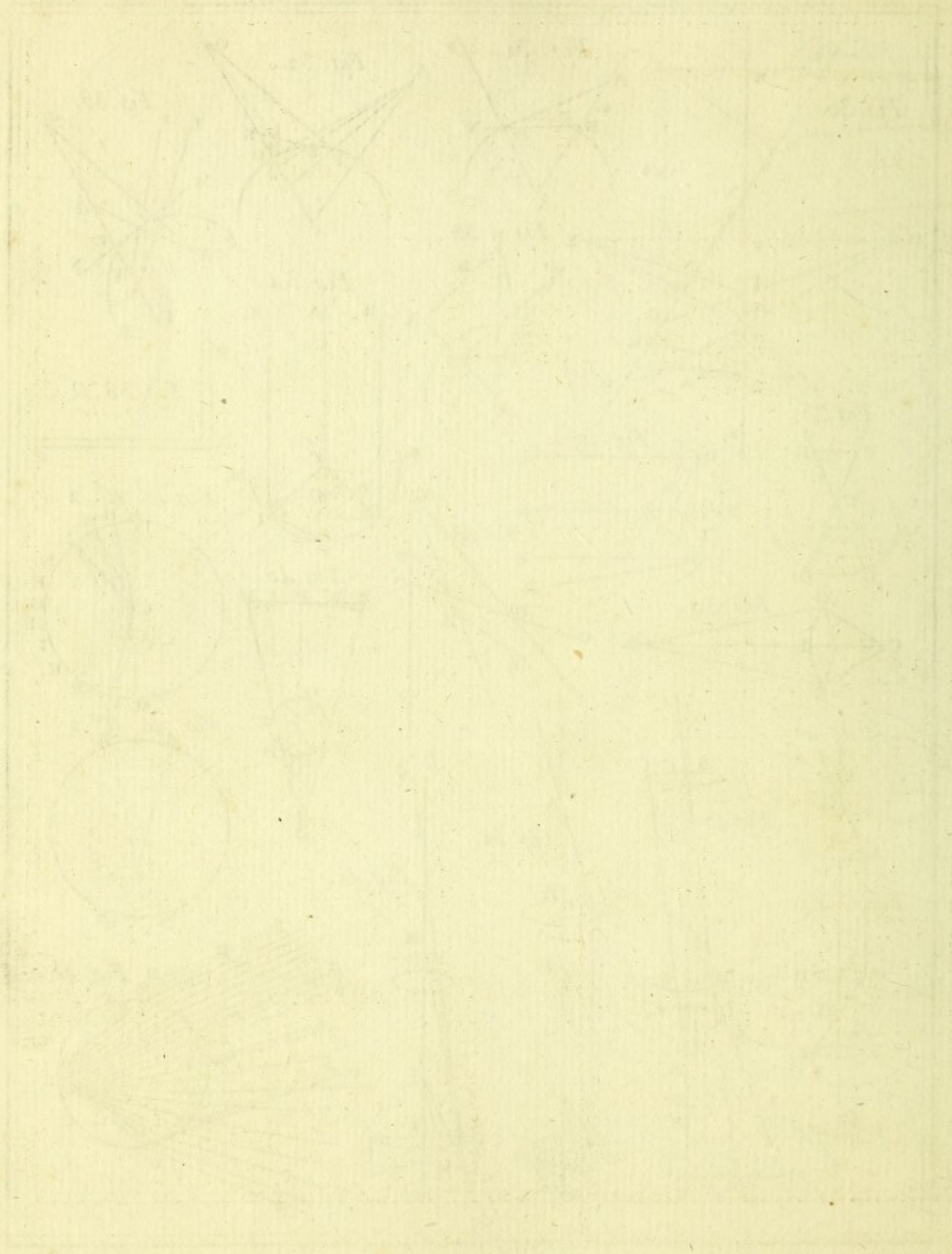


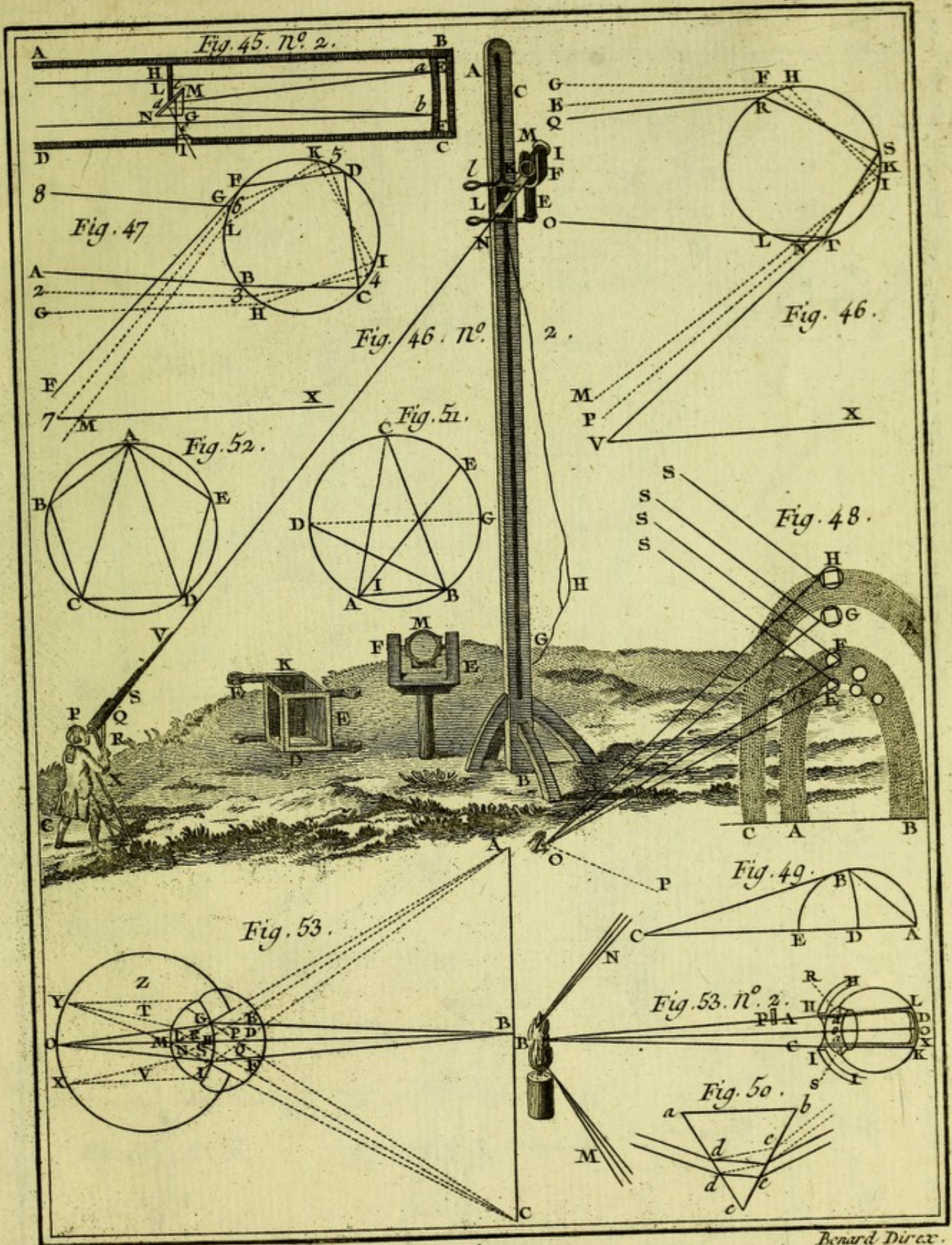
Optique.

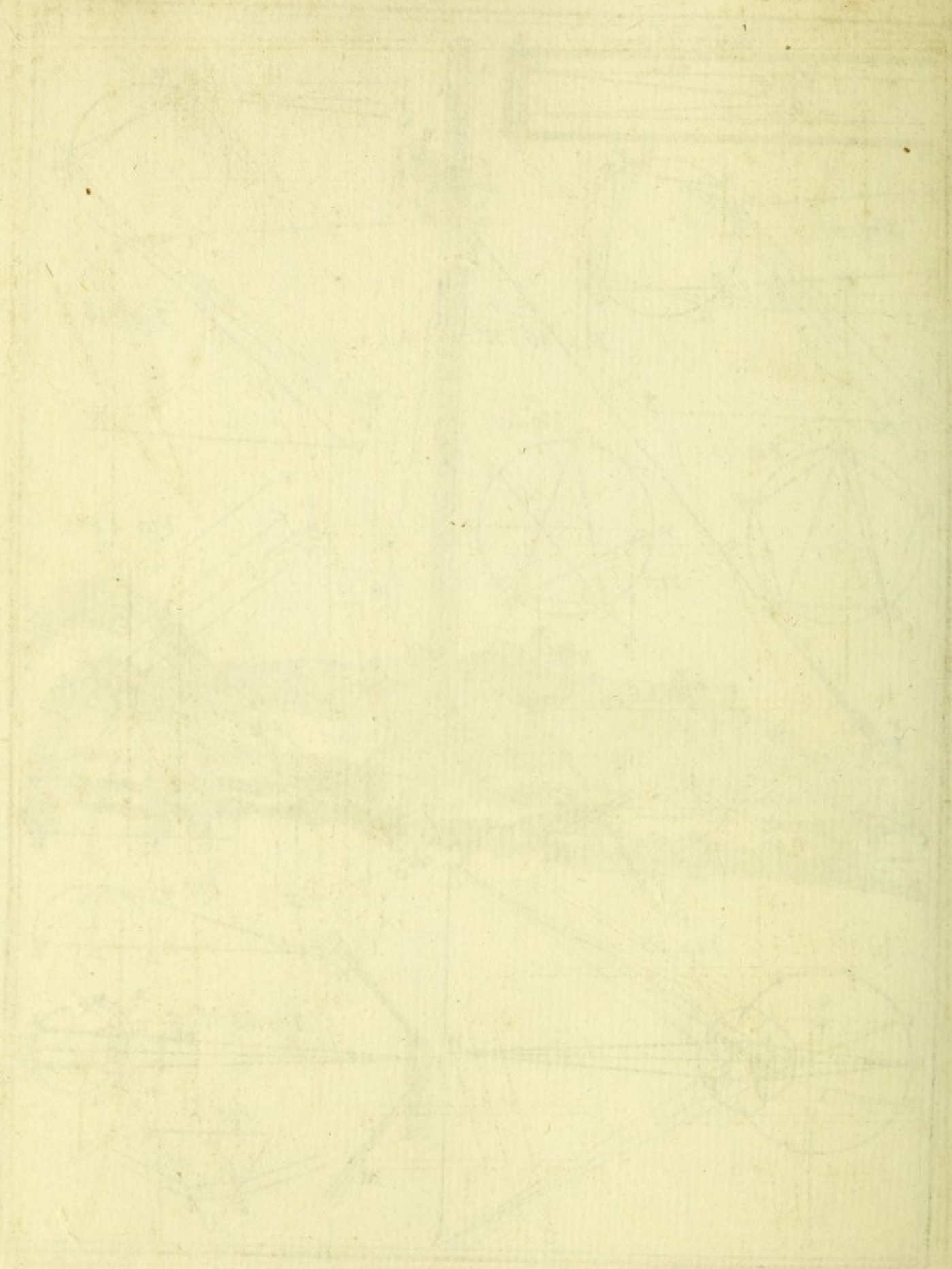
Bernard Dircx.











SHANK

